

DORMER  **PRAMET**

**OBRÁBĚNÍ
OTVORŮ**

2021 – 2022



 **DORMER**

 **PRAMET**



6		WMG A ISO 13399
12	MONOLITNÍ VRTÁKY	NÁVOD
15		MONOLITNÍ KARBIDOVÉ VRTÁKY
66		HSS VRTÁKY
176		TECHNICKÉ INFORMACE
186		ŘEZNÉ KAPALINY
190		VÝSTRUŽNÍKY A ZÁHLUBNÍKY
264	DESTIČKOVÉ VRTÁKY	NÁVOD
271		VRTÁKY HYDRA
297		TECHNICKÉ INFORMACE
307		DESTIČKOVÉ VRTÁKY
327		TECHNICKÉ INFORMACE
350	VYVRTÁVACÍ SYSTÉMY	NÁVOD
359		VYVRTÁVACÍ HLAVY
376		PŘÍSLUŠENSTVÍ PRO VYVRTÁVÁNÍ
381		ŘEZNÉ DESTIČKY
404		UPÍNACÍ TRNY
418		VYVRTÁVACÍ SADY
429		TECHNICKÉ INFORMACE



SKUPINA PRODUKTŮ		SKUPINA PRODUKTŮ		SKUPINA PRODUKTŮ		SKUPINA PRODUKTŮ	
A		A243	120	B180	216	H	
A002	96	A244	121	B301	211	H851	287
A002S	98	A266	158	B334	208	H8512	294
A022	82	A295	172	B335	209	H853	289
A080	169	A296	173	B400	200	H855	291
A087	166	A345	146	B411	204	H858	293
A088	165	A350	144	B441	203	H860	295
A089	167	A400	150	B442	205	H861	296
A094	166	A402	151	B481	201	M	
A095	165	A405	152	B901	210	M150	173
A099	168	A412	153	B903	212	M151	174
A100	99	A413	154	B952	213	M152	174
A101	103	A510	111	B953	215	M200-1	187
A108	104	A520	88	B954	225	M200-2	187
A110	122	A530	140	B955	226	M200-3	188
A117	86	A553	113	B956	227	R	
A119	77	A620	84	B957	228	R100	34
A120	80	A720	91	G		R120	32
A122	78	A723	76	G106	238	R122	27
A123	79	A730	141	G107	242	R123	28
A124	90	A777	108	G125	249	R125	29
A125	128	A900	114	G129	234	R200	26
A130	134	A901	116	G132	244	R453	52
A147	106	A920	92	G135	230	R454	48
A160	110	A921	94	G136	236	R457	44
A166	143	A940	124	G137	232	R458	40
A170	118	A941	126	G138	245	R459	56
A188	172	A951	148	G142	240	R463	62
A190	170	A952	149	G149	235	R467	59
A191	171	A976	130	G154	233	R510	38
A199	169	A977	132	G171	247	R520	36
A200	155	A978	133	G236	250	R6011	30
A201	160	B		G314	248	R7131	31
A205	156	B100	206	G335	231	R950	281
A206	157	B101	222	G338	246	R960	283
A210	159	B121	224	G400	229	R970	285
A225	161	B122	214	G506	239		
A237	162	B157	220	G560	237		
A238	163	B161	221	G570	241		
A242	164	B170	218	G600	243		



SKUPINA PRODUKTŮ		SKUPINA PRODUKTŮ		SKUPINA PRODUKTŮ		SKUPINA PRODUKTŮ	
Z		BS 54 KIT TC 8-210	427	EXT-BS	415	M	
2080-BS	411	BT-BS	408	F		MB-H	373
69871-BS	406	C		F75	367	MOR-BS	413
802D	313	CART-BS-SPC	378	F75-BB	369	R	
803D	315	CART-BS-STD	379	F75-C	368	RED-BS	416
804D	318	CHAM-BS	380	F90	370	W	
805D	320	D		F90-BB	372	WEL-BS	414
B		D75	361	F90-C	371		
BS 54 KIT RC 8-043	420	D75-BB	363	H			
BS 54 KIT RC 8-100	421	D75-C	362	HSK-BS	410		
BS 54 KIT RC 8-170	422	D90	364	I			
BS 54 KIT RC 8-210	423	D90-BB	366	ISO BARS	374		
BS 54 KIT TC 8-043	424	D90-C	365	ISO BARS A042	375		
BS 54 KIT TC 8-100	425	E		L			
BS 54 KIT TC 8-170	426	EP	322	LA-BS	417		

SKUPINA PRODUKTŮ		SKUPINA PRODUKTŮ	
C		S	
CCGT	388	SCET	323
CCGW CBN	390	T	
CCMT	390	TCGT	401
CCMW	393	TCMT	402
CNGA CBN	394	TCMW	403
CNGG	395	W	
CNMA	395	WCMT-ID	325
CNMG	396	WCMX	326
D		X	
DCMT	398	XPET	324
DCMW	399		
DCMW PCD	399		
E			
EPGX	400		
EPMT	400		



DORMER PRAMET



ÚSPORA V KAPSE

Mobilní aplikace **Kalkulátor řezných podmínek** je užitečný nástroj kapesní velikosti, který Vám pomůže udržet hotovost v kapse! Jsme jednoduše spolehliví.

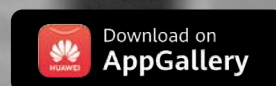
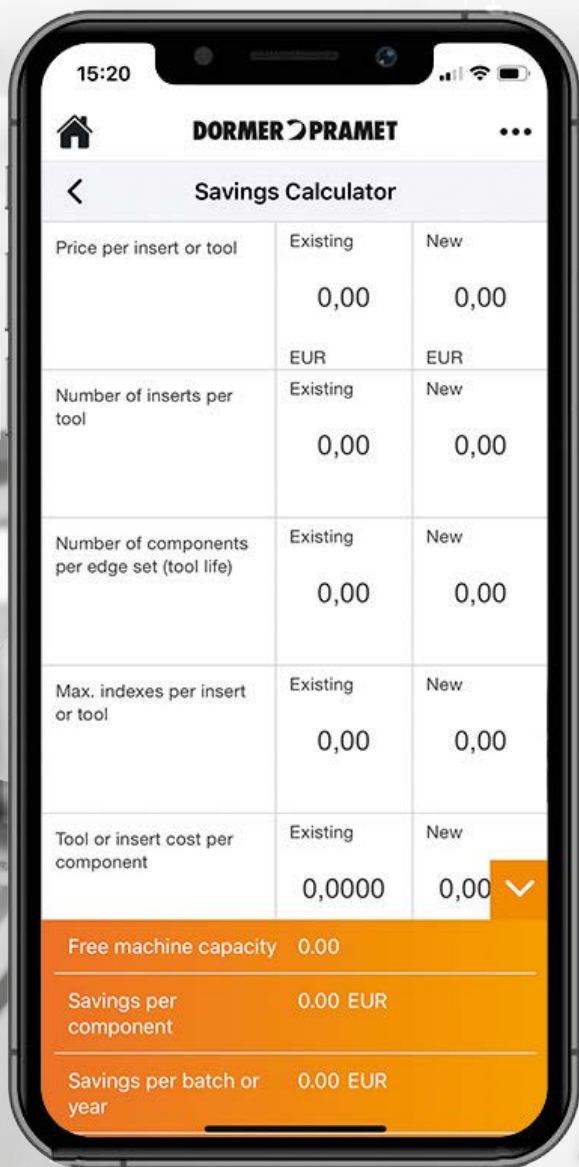



6		WMG A ISO 13399
12	MONOLITNÍ VRTÁKY	NÁVOD
15		MONOLITNÍ KARBIDOVÉ VRTÁKY
66		HSS VRTÁKY
176		TECHNICKÉ INFORMACE
186		ŘEZNÉ KAPALINY
190		VÝSTRUŽNÍKY A ZÁHLUBNÍKY
264	DESTIČKOVÉ VRTÁKY	NÁVOD
271		VRTÁKY HYDRA
297		TECHNICKÉ INFORMACE
307		DESTIČKOVÉ VRTÁKY
327		TECHNICKÉ INFORMACE
350	VYVRTÁVACÍ SYSTÉMY	NÁVOD
359		VYVRTÁVACÍ HLAVY
376		PŘÍSLUŠENSTVÍ PRO VYVRTÁVÁNÍ
381		BŘITOVÉ DESTIČKY
404		UPÍNACÍ TRNY
418		VYVRTÁVACÍ SADY
429		TECHNICKÉ INFORMACE



SKUPINY OBRÁBĚNÝCH MATERIÁLŮ (WMG)

ISO Pro výběr materiálu řezného nástroje a geometrie pro širokou škálu materiálů obrobků

Obecná definice
tj. ocel, korozivzdorná ocel...

P **M** **K** **N** **S** **H**

Podskupina Pro volbu vhodného nástroje pro specifičtější rozdělení materiálů obrobků

Rozdělení podle struktury/složení
tj. běžná uhlíková ocel, legovaná ocel...

P **M** **K** **N** **S** **H**

P1

P2

P3

P4

WMG Pro výběr počátečních řezných podmínek s rozsahem $\pm 10\%$

Rozdělení podle tvrdosti/meze pevnosti v tahu
tj. $160 < 220 \text{ HB}$, $620 < 900 \text{ N/mm}^2$...

P

P1 **P1.1** **P1.2** **P1.3**

P2 **P2.1** **P2.2** **P2.3**

P3 **P3.1** **P3.2** **P3.3**

P4 **P4.1** **P4.2** **P4.3**

ROZLIŠENÍ OBRÁBĚNÝCH MATERIÁLŮ SPOLEČNOSTI DORMER PRAMET

Skupiny materiálů obrobků (WMG) se používají k usnadnění výběru správného řezného nástroje a k výběru počátečních řezných podmínek v konkrétním použití.

Norma ISO 513 klasifikuje obráběné materiály do šesti různě zbarvených skupin:

- **Modrá:** ocel a ocelolitina (skupina P)
- **Žlutá:** korozivzdorná ocel (skupina M)
- **Červená:** litina (skupina K)
- **Zelená:** neželezné kovy (skupina N)
- **Hnědá:** žárupevné slitiny (skupina S)
- **Šedá:** kalené materiály (skupina H)

Šest základních ISO skupin se dále dělí na podskupiny na základě struktury a složení materiálů. Například ocel a ocelolitina skupiny P se dělí na tyto čtyři podskupiny:

- P1 – **automatová ocel**
- P2 – **běžná uhlíková ocel**
- P3 – **legovaná ocel**
- P4 – **nástrojová ocel**

Třetí úroveň rozdělení zahrnuje vlastnosti materiálu, jako je tvrdost a mez pevnosti v tahu. Zde poskytujeme našim zákazníkům výběr vhodného nástroje, včetně doporučených počátečních řezných podmínek.

Tabulka na následující straně uvádí popis jednotlivých skupin obráběných materiálů a příklady běžně používaných označení.



WMG (SKUPINY OBRÁBĚNÝCH MATERIÁLŮ)

ISO	WMG (Skupiny materiálů obrobků)		Tvrdoost (HB nebo HRC)	Mez pevnosti v tahu (MPa)		
P	P1	P1.1	Síru	< 240 HB	≤ 830	
		P1.2	Automatová uhlíková ocel obsahující (uhlíková ocel se zvýšenou obrobitelností)	Síru a fosfor	< 180 HB	≤ 620
		P1.3		Síru/fosfor a olovo	< 180 HB	≤ 620
	P2	P2.1	Běžná uhlíková ocel	S obsahem < 0.25 % C	< 180 HB	≤ 620
		P2.2	(zejména oceli s obsahem železa a uhlíku)	S obsahem < 0.55 % C	< 240 HB	≤ 830
		P2.3		S obsahem > 0.55 % C	< 300 HB	≤ 1030
	P3	P3.1	Legovaná ocel	Žíhaná	< 180 HB	≤ 620
		P3.2	(uhlíkové oceli s obsahem legujících prvků ≤ 10 %)		180 – 260 HB	> 620 ≤ 900
		P3.3		Vytvrzená a temperovaná	260 – 360 HB	> 900 ≤ 1240
	P4	P4.1	Nástrojová ocel	Žíhaná	< 26 HRC	≤ 900
P4.2		(legovaná ocel pro nástroje, zápustky a formy)		26 – 39 HRC	> 900 ≤ 1240	
P4.3			Vytvrzená a temperovaná	39 – 45 HRC	> 1240 ≤ 1450	
M	M1	M1.1	Korozivzdorná feritická ocel	< 160 HB	≤ 520	
		M1.2	(nevytvrditelné slitiny s obsahem chromu)	160 – 220 HB	> 520 ≤ 700	
	M2	M2.1	Korozivzdorná martensitická ocel	Žíhaná	< 200 HB	≤ 670
		M2.2	(vytvrditelné slitiny s obsahem chromu)	Kalená a temperovaná	200 – 280 HB	> 670 ≤ 950
		M2.3		Precipitačně vytvrzená	280 – 380 HB	> 950 ≤ 1300
	M3	M3.1	Korozivzdorná austenitická ocel		< 200 HB	≤ 750
		M3.2	(s obsahem chromu, niklu a slitiny s obsahem chromu, niklu a manganu)		200 – 260 HB	> 750 ≤ 870
		M3.3			260 – 300 HB	> 870 ≤ 1040
	M4	M4.1	Korozivzdorná (Duplexní) ocel, austeniticko-feritická nebo superaustenitická		< 300 HB	≤ 990
		M4.2	Korozivzdorná austenitická ocel, precipitačně vytvrzená		300 – 380 HB	≤ 1320
K	K1	K1.1	Šedá litina	Feritická nebo feriticko-perlitická	< 180 HB	≤ 190
		K1.2	(odlitky s obsahem uhlíku a železa s lamelární grafitou mikrostrukturou)	Feriticko-perlitická nebo perlitická	180 – 240 HB	> 190 ≤ 310
		K1.3		Perlitická	240 – 280 HB	> 310 ≤ 390
	K2	K2.1	Temperovaná litina (ASTM A602)	Feritická	< 160 HB	≤ 400
		K2.2	(litina s vločkovým grafitem s tvrdostí)	Feritická nebo perlitická	160 – 200 HB	> 400 ≤ 550
		K2.3		Perlitická	200 – 240 HB	> 550 ≤ 660
	K3	K3.1	Tvárná litina	Feritická	< 180 HB	≤ 560
		K3.2	(odlitky s obsahem železa a uhlíku s nodulární/globulární grafitovou mikrostrukturou)	Feritická nebo perlitická	180 – 220 HB	> 560 ≤ 680
		K3.3		Perlitická	220 – 260 HB	> 680 ≤ 800
	K4	K4.1	Austenitická šedá litina (slitinové odlitky s obsahem železa, uhlíku a austenitickou lamelární grafitovou mikrostrukturou)		< 180 HB	≤ 190
K4.2		Austenitická tvárná litina (slitinové odlitky s obsahem železa, uhlíku a austenitickou nodulární grafitovou mikrostrukturou)		< 240 HB	≤ 740	
K4.3		Izotermicky kalená tvárná litina		< 280 HB	> 840 ≤ 980	
K4.4		(slitinové odlitky s obsahem železa a uhlíku s ausferitickou mikrostrukturou)		280 – 320 HB	> 980 ≤ 1130	
K4.5				320 – 360 HB	> 1130 ≤ 1280	
K5	K5.1	Litina s vermikulárním (kompaktním) grafitem (ASTM A842)	Feritická	< 180 HB	≤ 400	
	K5.2	(litina s vermikulárním grafitem s tvrdostí)	Feriticko-perlitická	180 – 220 HB	> 400 ≤ 450	
	K5.3		Perlitická	220 – 260 HB	> 450 ≤ 500	
N	N1	N1.1	Čistý hliník a tvářené slitiny hliníku		< 60 HB	≤ 240
		N1.2	Tvářené slitiny hliníku	Polo vytvrzené	60 – 100 HB	> 240 ≤ 400
		N1.3		Vytvrzené	100 – 150 HB	> 400 ≤ 590
	N2	N2.1			< 75 HB	≤ 240
		N2.2	Odlévané slitiny hliníku		75 – 90 HB	> 240 ≤ 270
		N2.3			90 – 140 HB	> 270 ≤ 440
	N3	N3.1	Automatové slitiny mědi s vynikajícími vlastnostmi při obrábění		–	–
		N3.2	Slitiny mědi s krátkou tržskou a dobrými nebo středně dobrými vlastnostmi při obrábění		–	–
		N3.3	Elektrolytická měď a slitiny mědi s dlouhou tržskou se středně dobrými až nepříznivými vlastnostmi při obrábění		–	–
	N4	N4.1	Termoplastické polymery		–	–
N4.2		Termosetové polymery		–	–	
N4.3		Vyztužené polymery a kompozity		–	–	
N5	N5.1	Grafit		–	–	
S	S1	S1.1		< 200 HB	≤ 660	
		S1.2	Titan nebo slitiny titanu	200 – 280 HB	> 660 ≤ 950	
		S1.3		280 – 360 HB	> 950 ≤ 1200	
	S2	S2.1	Žárupevné slitiny na bázi Fe	< 200 HB	≤ 690	
		S2.2		200 – 280 HB	> 690 ≤ 970	
	S3	S3.1	Žárupevné slitiny na bázi Ni	< 280 HB	≤ 940	
		S3.2		280 – 360 HB	> 940 ≤ 1200	
	S4	S4.1	Žárupevné slitiny na bázi Co	< 240 HB	≤ 800	
S4.2			240 – 320 HB	> 800 ≤ 1070		
H	H1	H1.1	Tvrzená litina	< 440 HB	–	
		H1.2		< 55 HRC	–	
	H2	H2.1	Kalená litina	> 55 HRC	–	
		H2.2		< 51 HRC	–	
	H3	H3.1	Kalená ocel s tvrdostí < 55 HRC	51 – 55 HRC	–	
		H3.2		> 55 HRC	–	
H4	H4.1	Kalená ocel s tvrdostí > 55 HRC	55 – 59 HRC	–		
	H4.2		> 59 HRC	–		



PARAMETRY ŘEZNÝCH NÁSTROJŮ DLE ISO 13399

Všechny řezné nástroje jsou definovány řadou parametrů daných normou ISO 13399. Tento seznam obsahuje všechny parametry použité v tomto katalogu a jejich definice.

ISO 13399 představuje mezinárodní normu pro údaje o řezných nástrojích. Poskytuje rozměry a parametry v neutrálním formátu, který je nezávislý na jakémkoli konkrétním systému nebo názvosloví společnosti. Pokud jsou řezné nástroje jasně definovány podle globálního standardu, mohou všechny typy softwaru zpracovávat elektronická data rychleji, což zlepšuje kvalitu komunikace a usnadňuje hladký tok výměny informací.

Podpora společného jazyka v našich popisech řezných nástrojů pomáhá k lepší komunikaci mezi systémy. Ušetří vám to značné množství času a umožní snadnější získávání vysoce kvalitních dat napříč našimi 40 000 monolitními a VBD nástroji. Díky použití systému kompatibilního s normou ISO 13399 nebude nutné ručně interpretovat data a zadávat je do systému.

PŘÍKLADY:

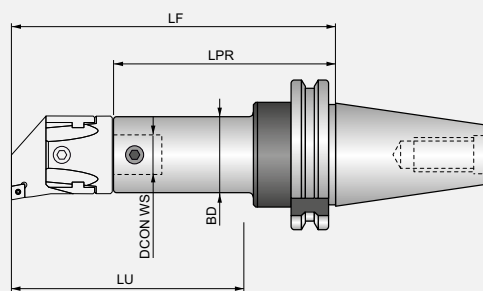
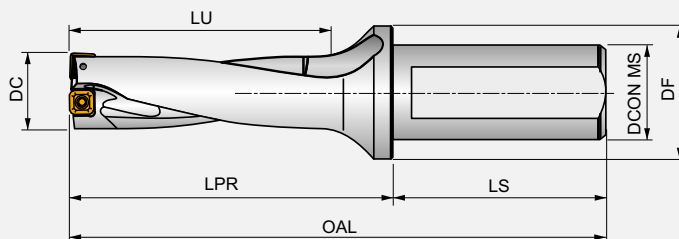
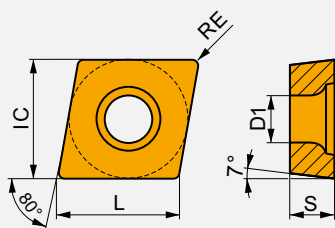
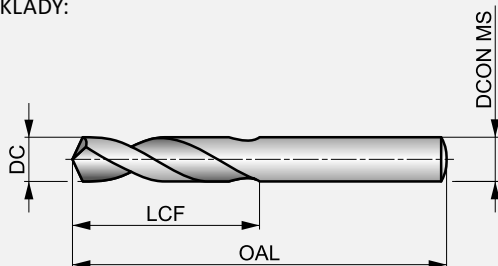

ISO 13399	popis
BD	Průměr těla
BDX	Maximální průměr těla
CZC MS	Kód velikosti připojení na straně stroje
D1	Průměr upevňovacího otvoru
DC	Řezný průměr
DCN	Minimální řezný průměr
DCON MS	Průměr připojení na straně stroje
DCON WS	Průměr připojení na straně obrobku
DCX	Maximální řezný průměr
DHUB	Průměr náboje
FLGT	Tloušťka příruby
IC	Průměr opsané kružnice
L	Délka řezné hrany
LB	Délka těla
LF	Funkční délka
LPR	Vyčnívací délka
LU	Použitelná délka
OAL	Celková délka
RE	Rádus rohu
S	Tloušťka destičky
WF	Funkční šířka
APMX	Maximální hloubka řezu
D1	Průměr upevňovacího otvoru
DC_1	Řezný průměr první řezný krok
DC_2	Řezný průměr druhý řezný krok

ISO 13399	popis
DF	Průměr příruby
DH	Průměr hlavy
GPD	Průměr vodička
GPL	Délka vodička
H	Výška stopky
HSD	Velikost části pohonu
IC	Průměr opsané kružnice
LCF	Délka drážky pro odvod třísek
LCOL	Délka pouzdra
LDC	Referenční bod vzdálenosti PK
LH	Délka hlavy
LS	Délka stopky
LSC	Délka upnutí
NOF	Počet drážek
PLGL	Délka zátky
RCSK	Rádus zapuštění
RE	Rádus rohu
SDI	Přírůstky průměru kroku
SDL	Délka průměru kroku
SDL_1	Délka průměru kroku první řezný krok
SDL_2	Délka průměru kroku druhý řezný krok
TDZ	Velikost průměru závitů
THLGTH	Délka závitů
WSC	Šířka upnutí



DORMER PRAMET



VAŠE OSOBNÍ KNIHOVNA

Stále se vracíte ke stejným částem našich publikací? Naše aplikace knihovny Vám umožní ukládat klíčové stránky, na které se můžete kdykoli vracet. **Jsme jednoduše spolehliví.**





MONOLITNÍ KARBIDOVÉ VRTÁKY HSS VRTÁKY





6		WMG A ISO 13399
12	MONOLITNÍ VRTÁKY	NÁVOD
15		MONOLITNÍ KARBIDOVÉ VRTÁKY
66		HSS VRTÁKY
176		TECHNICKÉ INFORMACE
186		ŘEZNÉ KAPALINY
190		
264	DESTIČKOVÉ VRTÁKY	NÁVOD
271		VRTÁKY HYDRA
295		TECHNICKÉ INFORMACE
307		DESTIČKOVÉ VRTÁKY
327		TECHNICKÉ INFORMACE
350	VYVRTÁVACÍ SYSTÉMY	NÁVOD
359		VYVRTÁVACÍ HLAVY
376		PŘÍSLUŠENSTVÍ PRO VYVRTÁVÁNÍ
381		ŘEZNÉ DESTIČKY
404		UPÍNACÍ TRNY
418		VYVRTÁVACÍ SADY
429		TECHNICKÉ INFORMACE



VRTÁKY – PŘEHLED STRÁNKY

DORMER

1

R100



3

Monolitní karbidový vrták, Leštěný

Vrták s velkou odolností proti opotřebení pro vysokou produktivitu a dlouhou životnost. Vrcholový úhel 120° a konstrukce se 4 fazetkami napomáhá vystředění a snižuje rezní síly. Pro použití na CNC strojích.

2

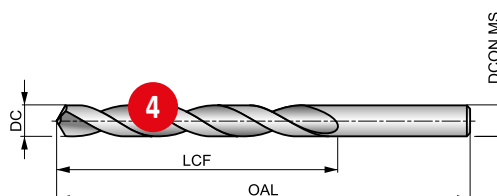

HM	DIN 338	4xD
120°	Bright	
20-35°	R	DC h7

5

Materiálové skupiny obrobků a vhodné startovací rezné podmínky (m/min) a posuv Alpha Code. Tabulku s posuvem na otáčku naleznete od strany 65.

P1.1	P1.2	P1.3	P2.1	P2.2	P2.3	P3.1	P3.2	P3.3	P4.1	P4.2	P4.3	K1.1	K1.2
99 S	111 S	115 S	85 S	75 S	66 S	66 S	53 S	45 S	40 S	34 S	27 S	75 T	56 T
K1.3	K2.1	K2.2	K2.3	K3.1	K3.2	K3.3	K4.1	K4.2	K4.3	K4.4	K4.5	K5.1	K5.2
42 T	68 T	55 T	44 T	60 T	46 T	37	55 T	42 T	31 T	26 T	22 T	63 T	47 T
K5.3	N1.1	N1.2	N1.3	N2.1	N2.2	N2.3	N3.1	N3.2	N4.1	N4.2	H1.1	H2.1	H2.2
37 T	200 V	150 V	100 V	172 V	155 V	112 V	423 V	250 V	60 X	100 V	56 S	33 S	36 S
H3.1	H3.2												
37 S	30 S												

6

Product	DC	DC	LCF	OAL	DCON MS
	[mm]	[inch]	[mm]	[mm]	[mm]
R1001.0	1.00	0.0394	12.0	34.0	1.00
R1001.1	1.10	0.0433	14.0	36.0	1.10
R1001.2	1.20	0.0472	16.0	38.0	1.20
R1001.3	1.30	0.0512	16.0	38.0	1.30
R1001.4	1.40	0.0551	18.0	40.0	1.40
R1001.5	1.50	0.0591	18.0	40.0	1.50
R1001.6	1.60	0.0630	20.0	43.0	1.60
R1001.7	1.70	0.0669	20.0	43.0	1.70
R1001.8	1.80	0.0709	22.0	46.0	1.80
R1001.9	1.90	0.0748	22.0	46.0	1.90
R1002.0	2.00	0.0787	24.0	49.0	2.00

7

8

Product	DC	DC	LCF	OAL	DCON MS
	[mm]	[inch]	[mm]	[mm]	[mm]
R1003.6	3.60	0.1417	39.0	70.0	3.60
R1003.7	3.70	0.1457	39.0	70.0	3.70
R1003.8	3.80	0.1496	43.0	75.0	3.80
R1003.9	3.90	0.1535	43.0	75.0	3.90
R1004.0	4.00	0.1575	43.0	75.0	4.00
R1004.1	4.10	0.1614	43.0	75.0	4.10
R1004.2	4.20	0.1654	43.0	75.0	4.20
R1004.3	4.30	0.1693	47.0	80.0	4.30
R1004.4	4.40	0.1732	47.0	80.0	4.40
R1004.5	4.50	0.1772	47.0	80.0	4.50
R1004.6	4.60	0.1811	47.0	80.0	4.60

Poz.	Popis
1	Označení vrtáku
2	Popis produktu
3	Zobrazení produktu
4	Schematické vyobrazení nástroje

Poz.	Popis
5	Parametry produktu
6	Doporučení skupiny materiálů vč. pokynů ohledně rezné rychlosti a posuvu
7	Kód produktu
8	Rozměry produktu

Typická stránka s vyobrazením upínače vrtáku – konkrétní detaily stránky se budou lišit.



MONOLITNÍ KARBIDOVÉ A HSS VRTÁKY – PŘEHLED IKON

OBEČNÉ IKONY

	Hlavní použití		Podmíněné použití
--	----------------	--	-------------------

APLIKAČNÍ ÚHEL

	Středicí vrták s 60° zahlubovacím stupněm		Středicí vrták se zahlubovacím stupněm s rádiem		Vrták pro předvrtání s úkošem 90° (pro závitování)
	Špička vrtáku 118°		Špička bodového vrtáku 90°/120°		Špička bodového vrtáku 150°
	Špička vrtáku 120°		Špička vrtáku na bodové svary 180°		Špička bodového vrtáku 90°
	Špička vrtáku 122°		Stupňovitý vrták (pro spojovací prvky) 180° zahloubení		Špička bodového vrtáku 120°
	Špička vrtáku 130°		Stupňovitý vrták (pro spojovací prvky) 90° zahloubení		
	Špička vrtáku 135°		Špička vrtáku 140°		

SKUPINA ZÁKLADNÍCH NOREM (BSG)

	BS 328 – Normy pro vrtáky a výstružníky		DIN 1899 – Normy pro mikrovrtáky		DIN 8037 – Normy pro vrtáky s karbidovou špičkou
	DIN 1869/1 – Normy pro vrtáky v extra dlouhých délkách s rovnou stopkou		DIN 333A – Normy pro středicí vrtáky		DIN 8374 – Normy pro stupňovité vrtáky Subland
	DIN 1869/2 – Normy pro vrtáky v extra dlouhých délkách s rovnou stopkou		DIN 333R – Normy pro záhlubníky s rovnou stopkou		DIN 8376 – Normy pro stupňovité vrtáky
	DIN 1869/3 – Normy pro vrtáky v extra dlouhých délkách s rovnou stopkou		DIN 338 – Normy pro vrtáky s rovnou stopkou		DIN 8377 – Normy pro stupňovité vrtáky Subland
	DIN 1870 (1) – Normy pro vrtáky v extra dlouhých délkách se stopkou s kuzelem Morse		DIN 340 – Normy pro prodloužené vrtáky		DIN/ANSI Normy
	DIN 1870 (2) – Normy pro vrtáky v extra dlouhých délkách se stopkou s kuzelem Morse		DIN 341 – Normy pro dlouhé vrtáky s Morse kuzelem		Normy Dormer
	DIN 1897 – Normy pro krátké vrtáky		DIN 345 – Normy pro vrtáky s Morse kuzelem		NAS907 – Normy pro vrtáky pro letecký průmysl

POVLAK

	Nitrid hliníku a chromu (s hlazením)		Povrchová úprava oxidem bronzu		Nitrid titanu a hliníku (s hlazením)
	Broušený (bez povlaku)		Kombinace broušeného a vaporizovaného povrchu		Povlak nitridem titanu a hliníku
	Broušený povrch s TiAlN (povlak špičky)		Povrchová úprava vaporizací (černění)		Povlak nitridem titanu



MONOLITNÍ KARBIDOVÉ A HSS VRTÁKY – PŘEHLED IKON

VLASTNOST DODÁVKY CHLADICÍ KAPALINY (CSP)

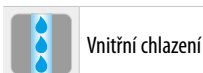

Vnitřní chlazení

SMĚR ŘEZU



Levostranné otáčení / řez



Pravostranné otáčení / řez

TŘÍDA TOLERANČNÍHO POLE ŘEZNÉHO PRŮMĚRU (TCDC)

DC
h8

h8 – Toleranční pole nástrojů pro průmyslovou normu (na základě rozsahu průměrů)

DC
h7

h7 – Toleranční pole nástrojů pro průmyslovou normu (na základě rozsahu průměrů)

DC
m7

m7 – Toleranční pole nástrojů pro průmyslovou normu (na základě rozsahu průměrů)

DC
h6

h6 – Toleranční pole nástrojů pro průmyslovou normu (na základě rozsahu průměrů)

KÓD MATERIÁLU (BMC)

HM

Tvrký materiál (monolitní karbid)

HSS
HM

HSS (tělo nástroje) s monolitním karbidem (materiál řezného nástroje)

HSS

Materiál nástroje HSS

HSS-E

Materiál nástroje z kobaltové oceli HSS

STOPKA



Válcová stopka / rovná stopka



Válcová stopka s unášečem



Stopka kužele Morse



Válcová stopka s ploškou



Válcová stopka DIN 6535 HA



Zkrácená válcová stopka

TVAR SPIRÁLY



Provedení s drážkou s rychlou spirálou



Provedení s drážkou se standardní spirálou



Drážka s plynulým ztenčováním jádra (CTW = Continously Thinned Web)



Provedení s drážkou s pomalou spirálou



Provedení s drážkou s rychlou spirálou



Provedení se speciálním ztenčením hrotu

POMĚR POUŽITELNÉ DÉLKY A PRŮMĚRU (ULDR)

1.25xD

Poměr použitelné hloubky nástroje k průměru 1,25 × D

2.5xD

Poměr použitelné hloubky nástroje k průměru 2,5 × D

5xD

Poměr použitelné hloubky nástroje k průměru 5 × D

1.5xD

Poměr použitelné hloubky nástroje k průměru 1,5 × D

20xD

Poměr použitelné hloubky nástroje k průměru 20 × D

6xD

Poměr použitelné hloubky nástroje k průměru 6 × D

10xD

Poměr použitelné hloubky nástroje k průměru 10 × D

25xD

Poměr použitelné hloubky nástroje k průměru 25 × D

8xD

Poměr použitelné hloubky nástroje k průměru 8 × D

15xD

Poměr použitelné hloubky nástroje k průměru 15 × D

3xD

Poměr použitelné hloubky nástroje k průměru 3 × D

1xD

Poměr použitelné hloubky nástroje k průměru 1 × D

4xD

Poměr použitelné hloubky nástroje k průměru 4 × D



MONOLITNÍ KARBIDOVÉ VRTÁKY



FORCE X

VYSOCE VÝKONNÉ KARBIDOVÉ VRTÁKY

UNIVERZÁLNÍ A PRODUKTIVNÍ VRTÁKY PRO ŠIROKOU OBLAST MATERIÁLŮ

FORCE X karbidové vrtáky jsou vyvinuty pro vysoce výkonné vrtání v širokém spektru obráběných materiálů jako jsou uhlíkové a legované oceli do pevnosti 1500 MPa a litiny. Vrtáky FORCE X jsou velmi produktivní také při vrtání nerez ocelí a hliníku.

VLASTNOSTI A VÝHODY

- TM CTW  – Unikátní konstrukce drážky s plynulým ztenčováním jádra a válcovaným dnem.
- Upravená špička se čtyřmi fazetkami a speciální geometrií příčného břitu.
- Prémiový mikrozrný karbid s povlakem TiAlN.
- Varianty 3xD a 5xD s vnitřním chlazením i bez vnitřního chlazení.
- Varianta 8xD s vnitřním chlazením.

VE SROVNÁNÍ S KONVENČNÍMI VRTÁKY JSOU FORCE X:

- **Mimořádně ekonomické** – mohou být mnohonásobně přebrušovány ke zvýšení životnosti.
- Poskytují konzistentní kvalitu ustředění, utváření třísky a vynikající toleranci a jakost povrchu otvorů.
- Vysoce produktivní, s dlouhou životností i za vysokých řezných rychlostí.



DOSTUPNÉ VARIANTY

3xD



R457

S vnitřním chlazením

R458

Bez vnitřního chlazení

- 3.00 – 20.00 mm
- 1/8 – 3/4 inch, N30 – N1, A – Z

5xD



R453

S vnitřním chlazením

R454

Bez vnitřního chlazení

- 3.00 – 20.00 mm
- 1/8 – 3/4 inch, N30 – N1, A – Z

8xD



R459

S vnitřním chlazením

- 3.00 – 16.00 mm
- 1/8 – 5/8 inch

**PŘÍKLADY OBRÁBĚNÍ**

			Automatová ocel P1.3	Legovaná ocel P3.3	Šedá litina K1.2
Obráběný materiál			1.0718 (11SMnPb30)	1.6582 (34CrNiMo6)	0.6025 (GG-25)
Tvrдость		HB	180	325	215
Pevnost v tahu		MPa	620	1120	260
Průměr		mm	8 (R4578.0)	8 (R4598.0)	8 (R4538.0)
Hloubka otvoru		mm	3×D (24)	8×D (64)	5×D (40)
Řezná rychlost	v_c	m/min	207	73	77
Posuv	f	mm/rev	0.26	0.14	0.26
Chlazení			Emulze 8 %, vnitřní chlazení	Emulze 8 %, vnitřní chlazení	Emulze 8 %, vnitřní chlazení



FORCE M

VYSOCE VÝKONNÉ KARBIDOVÉ VRTÁKY

VYSOCE PRODUKTIVNÍ VRTÁKY PRO NEREZ OCELI

FORCE M karbidové vrtáky byly vyvinuty pro vysoce výkonné vrtání a spolehlivý řezný proces při vrtání nerez ocelí a žáruvzdorných superslitin. FORCE M jsou ideální volbou pro sériovou výrobu velkého množství otvorů s konstantní přesností.

VLASTNOSTI A VÝHODY

- TM CTW  – Unikátní konstrukce drážky s plynulým ztenčováním jádra a válcovaným dnem..
- S-Shape - Špička vrtáku se čtyřmi fazetkami, přesnou rektifikací ostří a zesílenou konstrukcí rohů na hlavním ostří.
- Prémiový mikrozrnitý karbid s povlakem TiAlN.
- Varianty 3xD a 5xD s vnitřním chlazením.
- Varianta 8xD s vnitřním chlazením - na objednávku.

VE SROVNÁNÍ S KONVENČNÍMI VRTÁKY FORCE M POSKYTUJÍ:

- Spolehlivý výkon, hladký řez bez studeného vytvrzování obráběného materiálu a bez nalepování třísek.
- Optimalizovaný řezný proces s řízeným utvářením třísky a vylepšeným rozdělením řezných sil ke zvýšení produktivity.
- **Vynikající životnost** – vlivem konstrukce se zesílenými rohy a ostří s vysokou odolností deformačnímu opotřebením.



DOSTUPNÉ VARIANTY

3xD



R467

S vnitřním chlazením

- 3.00 – 16.00 mm
- 1/8 – 5/8 inch

5xD



R463

S vnitřním chlazením

- 3.00 – 16.00 mm
- 1/8 – 5/8 inch

8xD



R469

S vnitřním chlazením

K dispozici na vyžádání

- 3.00 – 16.00 mm
- 1/8 – 5/8 inch

**PŘÍKLADY OBRÁBĚNÍ**

			Feritická SST M1.2	Austenitická SST M3.2	Vysoce pevnostní SST M4.1
Obráběný materiál			1.4104 (AISI 430F)	1.4401 (AISI 316)	1.4501 (Super DUPLEX)
Tvrдость		HB	220	200	240
Pevnost v tahu		MPa	700	750	770
Průměr		mm	8 (R4678.0)	8 (S-R4698.0)	8 (R4638.0)
Hloubka otvoru		mm	3×D (24)	8×D (64)	5×D (40)
Řezná rychlost	v_c	m/min	99	74	57
Posuv	f	mm/rev	0.16	0.14	0.12
Coolant			Emulze 8 %, vnitřní chlazení	Emulze 8 %, vnitřní chlazení	Emulze 8 %, vnitřní chlazení



FORCE N

VYSOCE VÝKONNÉ KARBIDOVÉ VRTÁKY

VYSOCE PRODUKTIVNÍ VRTÁKY PRO HLINÍKOVÉ SLITINY

FORCE N karbidové vrtáky jsou doporučeny pro vysokorychlostní vrtání obrobků z hliníkových slitin. Šroubovice vrtáku i geometrie bříty jsou konstruovány pro utváření krátkých třísek a jejich plynulému odvádění z místa řezu. Vrtáky FORCE N poskytují vynikající výkon i životnost a jsou určeny především pro střední a velkosériovou výrobu.

VLASTNOSTI A VÝHODY

- Speciální drážka se ztenčováním jádra a zvětšeným úhlem.
- Unikátní geometrie s konvexní řeznou hranou a čtyřmi fazetkami pro ustředění vrtáku.
- Prémiový mikrozrnitý karbid s finální úpravou leštěním.
- 5×D a 8×D s vnitřním chlazením - na objednávku.

VE SROVNÁNÍ S KONVENČNÍMI VRTÁKY FORCE N POSKYTUJÍ:

- Vynikající výkon a dlouhá životnost i za vysokých řezných rychlostí.
- **Ekonomické řešení** - mohou být použity pro všechny typy hliníku i jeho abrazivních slitin.
- **Optimalizovaný řezný proces** – navržená geometrie snižuje řezné síly, zlepšuje kvalitu otvoru a redukuje možný otřep na výstupu.

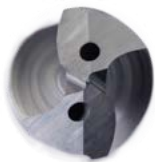

DOSTUPNÉ VARIANTY

5×D



R445

S vnitřním chlazením

Dostupné na
objednávku

- 3.00 – 16.00 mm
- 1/8 – 5/8 inch

8×D



R448

S vnitřním chlazením

Dostupné
na objednávku

- 3.00 – 16.00 mm
- 1/8 – 5/8 inch

12×D

Dostupné na
objednávku - lze objednat
i delší provedení.



PŘÍKLADY OBRÁBĚNÍ

			Kovaný hliník N1.2	Litý hliník N2.2
Obráběný materiál			AW 2024-O (3.1355)	A242.0
Tvrдость		HB	50	75
Pevnost v tahu		MPa	200	220
Průměr		mm	8 mm (R4458.0)	8 mm (S-R4488.0)
Hloubka otvoru		mm	5×D (40)	8×D (64)
Řezná rychlost	v_c	m/min	357	374
Posuv	f	mm/rev	0.80	0.33
Chlazení			Emulze 8 %, vnitřní chlazení	Emulze 8 %, vnitřní chlazení

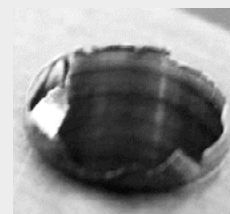

Otřep na výstupu - konvenční vrták

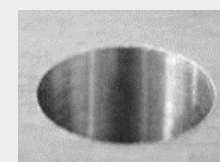

Bez otřepu - vrták FORCE N



DORMER PRAMET

SLEDUJTE NÁS



SDÍLEJTE



LAJKUJTE



KOMENTUJTE



OZNAČTE



RE-TWEETUJTE







MONOLITNÍ KARBID – NAVIGÁTOR PRO MATERIÁLY NÁSTROJE

Karbidové materiály

Karbidové materiály		<p>Substrát vyrobený slinováním pomocí práškové metalurgie sestávající z kompozitu kovového karbidu s pojivovým kovem. Nejvýznamnější surovinou je wolfram-karbid (WC). Wolfram-karbid přispívá k tvrdosti materiálu. Karbid tantalu (TaC), karbid titanu (TiC) a karbid niobu (NbC) doplňují WC a upravují vlastnosti podle požadavku. Tyto tři materiály se nazývají kubické karbidy. Kobalt (Co) působí jako pojivo a udržuje materiál pohromadě.</p> <p>Karbidové materiály se často vyznačují vysokou pevností v tlaku, vysokou tvrdostí, a tedy vysokou odolností vůči opotřebení, ale také omezenou pevností v ohybu a houževnatostí. Karbid se používá u závitníků, výstružníků, fréz, vrtáků a závitových fréz.</p>
----------------------------	---	--

Povrchové povlaky

Broušený (bez povlaku)		<p>Broušený povrch (povrch bez povlaku) zlepšuje tok třísek v měkkých nebo neželezných materiálech, plastech a kompozitech a udržuje ostré řezné hrany.</p>
Povlak nitridem titanu (TiN)		<p>Nitrid titanu je zlatě zbarvený keramický povlak aplikovaný fyzikálním nanášením par (PVD). Vysoká tvrdost v kombinaci s nízkým třením zajišťuje podstatně delší životnost nástroje a/nebo lepší řezný výkon oproti nástrojům, které nebyly opatřeny povlakem.</p>
Povlak nitridem titanu a hliníku (TiAlN)		<p>Povlak nitridem titanu a hliníku je vícevrstvý keramický povlak nanášený technologií PVD povlakování, která vykazuje vysokou houževnatost a oxidační stabilitu. Díky těmto vlastnostem je ideální pro vyšší rychlosti a posuvy a současně zvyšuje životnost nástroje. TiAlN se používá při vrtání, závitování a frézování a může být vhodný pro použití při obrábění bez chladicí kapaliny.</p>



Materiál nástroje (BMC)	HM	HM	HM	HM	HM	HM	HM	HM	HM	HM	HM	HM	HM
Norma (BSG)	DIN 333A	DORMER	DORMER	DORMER	DORMER	DORMER	DIN 6539	DIN 338	DIN 6539	DIN 338	DIN 6537K	DIN 6537K	DIN 6537L
Hĺoubka vrtání (ULDR)	1xD	1xD	1xD	1xD	1xD	3xD	2.5xD	4xD	2.5xD	4xD	3xD	3xD	5xD
Úhel vrcholu	60°	120°	90°	150°	90°	90°	120°	120°	130°	130°	140°	140°	140°
Povlak	Bright	Bright	Bright	TIAIN	TIAIN	TIAIN	Bright	Bright	TIN	TIN	TIAIN	TIAIN	TIAIN
Stopka					DIN 633SHA	DIN 633SHA					DIN 633SHA	DIN 633SHA	DIN 633SHA
Úhel šroubovice		λ 20-35°	λ 20-35°	λ 20-35°	λ 20-35°	λ 20-35°	λ 20-35°	λ 20-35°	λ 20-35°	λ 20-35°	CTW	CTW	CTW
Směr chodu (otáček)	R	R	R	R	R	R	R	R	R	R	R	R	R
Chlazení (CSP)													
Kód produktové řady	R200	R122	R123	R125	R6011	R7131	R120	R100	R520	R510	R458	R457	R454
	1.00 - 5.00	5.00 - 20.00	5.00 - 20.00	6.00 - 16.00	6.00 - 16.00	3.30 - 10.40	1.00 - 12.00	1.00 - 14.00	3.00 - 16.50	3.00 - 14.25	3.00 - 20.00	3.00 - 20.00	3.00 - 20.00
	26	27	28	29	30	31	32	34	36	38	40	44	48
P	P1	■	■	■	■	■	■	■	■	■	■	■	■
	P2	■	■	■	■	■	■	■	■	■	■	■	■
	P3	■	■	■	■	■	■	■	■	■	■	■	■
	P4	■	■	■	■	■	■	■	■	■	■	■	■
M	M1		■	■	■	■			■	■	■	■	■
	M2		■	■	■	■			■	■	■	■	■
	M3		■	■	■	■				■	■	■	■
	M4						■				■	■	■
K	K1	■	■	■	■	■	■	■	■	■	■	■	■
	K2	■	■	■	■	■	■	■	■	■	■	■	■
	K3	■	■	■	■	■	■	■	■	■	■	■	■
	K4	■	■	■	■	■	■	■	■	■	■	■	■
	K5	■	■	■	■	■	■	■	■	■	■	■	■
N	N1	■	■	■	■	■	■	■	■	■	■	■	■
	N2	■	■	■	■	■	■	■	■	■	■	■	■
	N3	■	■	■	■	■	■	■	■	■	■	■	■
	N4		■	■	■	■	■	■	■	■	■	■	■
	N5												
S	S1		■	■	■	■	■	■	■	■	■	■	■
	S2		■	■	■	■	■	■					
	S3		■	■	■	■	■	■					
	S4		■	■	■	■	■	■					
H	H1		■	■	■	■	■	■	■	■	■	■	■
	H2		■	■	■	■	■	■	■	■	■	■	■
	H3		■	■	■	■	■	■	■	■	■	■	■
	H4												

■ Hlavní použití ■ Podmíněné použití

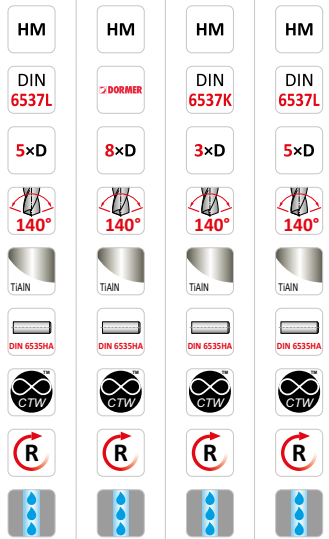

R453 **R459** **R467** **R463**

3.00 - 20.00 3.00 - 16.00 3.00 - 16.00 3.00 - 16.00

52 56 59 62

P1	■	■		
P2	■	■		
P3	■	■		
P4	■	■		
M1	▣	▣	■	■
M2	▣	▣	■	■
M3	▣	▣	■	■
M4	▣	▣	■	■
K1	■	■		
K2	■	■		
K3	■	■		
K4	■	■		
K5	■	■		
N1	■	▣		
N2	■	■		
N3	■	▣		
N4				
N5				
S1	■		■	■
S2			▣	▣
S3			▣	▣
S4			▣	▣
H1	■			
H2	▣			
H3	▣			
H4				



R200



Monolitní karbidový navrtávač, 118° vrcholový úhel, 60° zahloubení, Leštěný

Doporučen pro navrtání přesného otvoru na koncích hřídelí pro bezpečné upnutí před obráběním. Dva vrtací konce nástroje zvyšují životnost nástroje. Vhodný pro širokou oblast obráběných materiálů. 118° vrcholový úhel, 60° zahloubení. Vhodný pro CNC stroje.

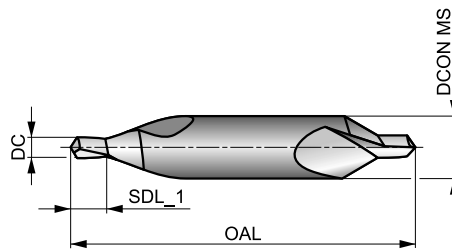

HM	DIN 333A	1xD
60°	Bright	
R		

Skupiny obráběných materiálů, startovní řezná rychlost (Vc m/min) a kód posuvu. Tabulku s posuvem na otáčku naleznete od strany 65.

P1.1 ■ 60 H	P1.2 ■ 67 H	P1.3 ■ 69 H	P2.1 ■ 51 H	P2.2 ■ 45 F	P2.3 ■ 40 D	P3.1 ■ 44 E	P3.2 ■ 36 E	P3.3 ■ 30 D	P4.1 ■ 26 E	P4.2 ■ 22 D	P4.3 ■ 18 C	K1.1 ■ 40 H	K1.2 ■ 30 E
K1.3 ■ 22 E	K2.1 ■ 37 D	K2.2 ■ 30 D	K2.3 ■ 24 D	K3.1 ■ 33 D	K3.2 ■ 25 D	K3.3 ■ 20 D	K4.1 ■ 30 D	K4.2 ■ 23 D	K4.3 ■ 17 D	K4.4 ■ 14 D	K4.5 ■ 12 D	K5.1 ■ 34 D	K5.2 ■ 26 D
K5.3 ■ 20 D	N1.1 ■ 120 I	N1.2 ■ 90 I	N1.3 ■ 60 H	N2.1 ■ 154 G	N2.2 ■ 138 G	N2.3 ■ 100 G	N3.1 ■ 169 G	N3.2 ■ 100 H	N3.3 ■ 50 F				

Produkt	DC	DC	SDL_1	OAL	DC ON MS
	(mm)	(inch)			
R2001.0X3.15	1.00	0.0394	1.7 - 1.3	31.0	3.15
R2001.25X3.15	1.25	0.0492	2.0 - 1.6	31.0	3.15
R2001.6X4.0	1.60	0.0630	2.6 - 2.0	35.0	4.00
R2002.0X5.0	2.00	0.0787	3.1 - 2.5	40.0	5.00
R2002.5X6.3	2.50	0.0984	3.8 - 3.1	45.0	6.30
R2003.15X8.0	3.15	0.1240	4.6 - 3.9	50.0	8.00
R2004.0X10.0	4.00	0.1575	5.9 - 5.0	55.0	10.00
R2005.0X12.5	5.00	0.1969	7.2 - 6.3	63.0	12.50



R122



Monolitní karbidový navrtávák s vrcholovým úhlem 120°, Leštěný

Precizně broušená geometrie navrtáváku pro přesné vedení při následném vrtání otvorů. Vrcholový úhel 120° napomáhá vystředění a snižuje řezné síly. Vhodný pro vrtání široké oblasti materiálů.

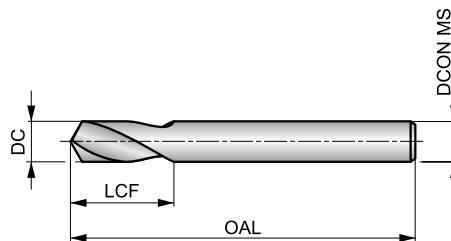

HM		1xD
120°	Bright	
λ 20-35°	R	DC h6

Skupiny obráběných materiálů, startovní řezná rychlost (Vc m/min) a kód posuvu. Tabulku s posuvem na otáčku naleznete od strany 65.

P1.1 ■ 99 S	P1.2 ■ 111 S	P1.3 ■ 115 S	P2.1 ■ 85 S	P2.2 ■ 75 S	P2.3 ■ 66 S	P3.1 ■ 66 S	P3.2 ■ 53 S	P3.3 ■ 45 S	P4.1 ■ 40 S	P4.2 ■ 34 S	P4.3 ■ 27 S	M1.1 ■ 73 S	M1.2 ■ 61 S
M2.1 ■ 65 S	M2.2 ■ 53 S	M3.1 ■ 52 S	M3.2 ■ 45 S	K1.1 ■ 75 T	K1.2 ■ 56 T	K1.3 ■ 42 T	K2.1 ■ 68 T	K2.2 ■ 55 T	K2.3 ■ 44 T	K3.1 ■ 60 T	K3.2 ■ 46 T	K3.3 ■ 37 T	K4.1 ■ 55 T
K4.2 ■ 42 T	K4.3 ■ 31 T	K4.4 ■ 26 T	K4.5 ■ 22 T	K5.1 ■ 63 T	K5.2 ■ 47 T	K5.3 ■ 37 T	N1.1 ■ 200 V	N1.2 ■ 150 V	N1.3 ■ 100 V	N2.1 ■ 172 V	N2.2 ■ 155 V	N2.3 ■ 112 V	N3.1 ■ 423 V
N3.2 ■ 250 V	N3.3 ■ 125 V	N4.1 ■ 60 X	N4.2 ■ 100 V	S1.1 ■ 45 T	S1.2 ■ 35 T	S1.3 ■ 25 S	S2.1 ■ 40 S	S2.2 ■ 28 S	S3.1 ■ 30 S	S3.2 ■ 20 S	S4.1 ■ 23 S	S4.2 ■ 16 S	H1.1 ■ 56 S
H2.1 ■ 33 S	H2.2 ■ 36 S	H3.1 ■ 37 S	H3.2 ■ 30 S										

Produkt	DC	DC	LCF	OAL	DCON MS
	(mm)	(inch)	(mm)	(mm)	(mm)
R1225.0	5.00	0.1969	16.0	62.0	5.00
R1226.0	6.00	0.2362	17.0	66.0	6.00
R1228.0	8.00	0.3150	22.0	79.0	8.00
R12210.0	10.00	0.3937	26.0	89.0	10.00
R12212.0	12.00	0.4724	30.0	102.0	12.00
R12216.0	16.00	0.6299	34.0	115.0	16.00
R12220.0	20.00	0.7874	40.0	131.0	20.00



R123



Monolitní karbidový navrtávač s vrcholovým úhlem 90°

Precizně broušená geometrie navrtávačku pro přesné vedení při následném vrtání otvorů. Vrcholový úhel 90° napomáhá vystředění a snižuje řezné síly. Vhodný pro vrtání široké oblasti materiálů.

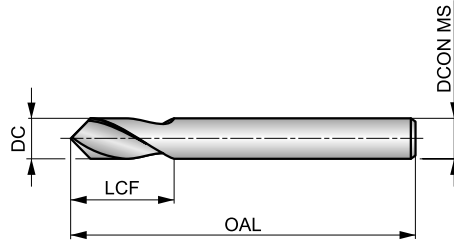

HM	DORMER	1xD
90°	Bright	
λ 20-35°	R	DC h6

Skupiny obráběných materiálů, startovní řezná rychlost (Vc m/min) a kód posuvu. Tabulku s posuvem na otáčku naleznete od strany 65.

P1.1 ■ 99 S	P1.2 ■ 111 S	P1.3 ■ 115 S	P2.1 ■ 85 S	P2.2 ■ 75 S	P2.3 ■ 66 S	P3.1 ■ 66 S	P3.2 ■ 53 S	P3.3 ■ 45 S	P4.1 ■ 40 S	P4.2 ■ 34 S	P4.3 ■ 27 S	M1.1 ■ 73 S	M1.2 ■ 61 S
M2.1 ■ 65 S	M2.2 ■ 53 S	M3.1 ■ 52 S	M3.2 ■ 45 S	K1.1 ■ 75 T	K1.2 ■ 56 T	K1.3 ■ 42 T	K2.1 ■ 68 T	K2.2 ■ 55 T	K2.3 ■ 44 T	K3.1 ■ 60 T	K3.2 ■ 46 T	K3.3 ■ 37 T	K4.1 ■ 55 T
K4.2 ■ 42 T	K4.3 ■ 31 T	K4.4 ■ 26 T	K4.5 ■ 22 T	K5.1 ■ 63 T	K5.2 ■ 47 T	K5.3 ■ 37 T	N1.1 ■ 200 V	N1.2 ■ 150 V	N1.3 ■ 100 V	N2.1 ■ 172 V	N2.2 ■ 155 V	N2.3 ■ 112 V	N3.1 ■ 423 V
N3.2 ■ 250 V	N3.3 ■ 125 V	N4.1 ■ 60 X	N4.2 ■ 100 V	S1.1 ■ 45 T	S1.2 ■ 35 T	S1.3 ■ 25 S	S2.1 ■ 40 S	S2.2 ■ 28 S	S3.1 ■ 30 S	S3.2 ■ 20 S	S4.1 ■ 23 S	S4.2 ■ 16 S	H1.1 ■ 56 S
H2.1 ■ 33 S	H2.2 ■ 36 S	H3.1 ■ 37 S	H3.2 ■ 30 S										

Produkt	DC	DC	LCF	OAL	DCON MS
	(mm)	(inch)	(mm)	(mm)	(mm)
R1235.0	5.00	0.1969	16.0	62.0	5.00
R1236.0	6.00	0.2362	17.0	66.0	6.00
R1238.0	8.00	0.3150	22.0	79.0	8.00
R12310.0	10.00	0.3937	26.0	89.0	10.00
R12312.0	12.00	0.4724	30.0	102.0	12.00
R12316.0	16.00	0.6299	34.0	115.0	16.00
R12320.0	20.00	0.7874	40.0	131.0	20.00

NEW**R125****DORMER**

Monolitní karbidový navrtávač s vrcholovým úhlem 150°, Povlakovaný TiAlN

Precizně broušená geometrie navrtávačku pro přesné vedení při následném vrtání otvorů. Vrcholový úhel 150° napomáhá vystředění a snižuje řezné síly. Povlak TiAlN zvyšuje produktivitu a prodlužuje životnost. Vhodný pro vrtání široké oblasti materiálů.

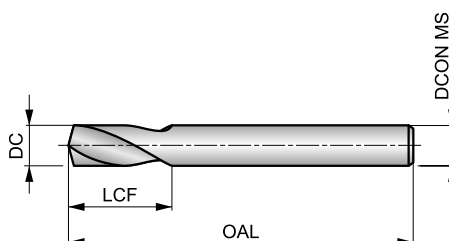

HM	DORMER	1×D
150°	TiAlN	
λ 20-35°	R	DC h6

Skupiny obráběných materiálů, startovní řezná rychlost (Vc m/min) a kód posuvu. Tabulku s posuvem na otáčku naleznete od strany 65.

P1.1 ■ 119 S	P1.2 ■ 134 S	P1.3 ■ 138 S	P2.1 ■ 102 S	P2.2 ■ 90 S	P2.3 ■ 80 S	P3.1 ■ 81 S	P3.2 ■ 65 S	P3.3 ■ 55 S	P4.1 ■ 48 S	P4.2 ■ 41 S	P4.3 ■ 34 S	M1.1 ■ 82 S	M1.2 ■ 70 S
M2.1 ■ 73 S	M2.2 ■ 60 S	M3.1 ■ 58 S	M3.2 ■ 50 S	K1.1 ■ 80 T	K1.2 ■ 59 T	K1.3 ■ 44 T	K2.1 ■ 86 T	K2.2 ■ 70 T	K2.3 ■ 56 T	K3.1 ■ 76 T	K3.2 ■ 58 T	K3.3 ■ 47 T	K4.1 ■ 71 T
K4.2 ■ 53 T	K4.3 ■ 39 T	K4.4 ■ 33 T	K4.5 ■ 28 T	K5.1 ■ 80 T	K5.2 ■ 60 T	K5.3 ■ 46 T	N1.1 ■ 200 V	N1.2 ■ 150 V	N1.3 ■ 100 V	N2.1 ■ 172 V	N2.2 ■ 155 V	N2.3 ■ 112 V	N3.1 ■ 423 V
N3.2 ■ 250 V	N3.3 ■ 125 V	N4.1 ■ 60 X	N4.2 ■ 100 V	S1.1 ■ 55 T	S1.2 ■ 45 T	S1.3 ■ 35 S	S2.1 ■ 53 S	S2.2 ■ 42 S	S3.1 ■ 40 S	S3.2 ■ 30 S	S4.1 ■ 31 S	S4.2 ■ 24 S	H1.1 ■ 56 S
H2.1 ■ 33 S	H2.2 ■ 36 S	H3.1 ■ 37 S	H3.2 ■ 30 S										

DCON MS v toleranci h6.

Produkt	DC (mm)	LCF (mm)	OAL (mm)	DCON MS (mm)
R1255.0	5.00	16.0	62.0	5.00
R1256.0	6.00	17.0	66.0	6.00
R1258.0	8.00	22.0	79.0	8.00
R12510.0	10.00	26.0	89.0	10.00
R12512.0	12.00	30.0	102.0	12.00
R12516.0	16.00	34.0	115.0	16.00



R6011



Monolitní karbidový navrtávák s vrcholovým úhlem 90°, Povlakovaný TiAlN

Precizně broušená geometrie navrtáváku pro přesné vedení při následném vrtání otvorů. Vrcholový úhel 90° napomáhá vystředění a snižuje řezné síly. Povlak TiAlN zvyšuje produktivitu a prodlužuje životnost. Vhodný pro vrtání široké oblasti materiálů.

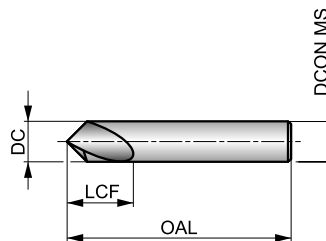

HM	DORMER	1xD
90°	TiAlN	DIN 6535HA
λ 20-35°	R	DC h6

Skupiny obráběných materiálů, startovní řezná rychlost (Vc m/min) a kód posuvu. Tabulku s posuvem na otáčku naleznete od strany 65.

P1.1 ■ 119 S	P1.2 ■ 134 S	P1.3 ■ 138 S	P2.1 ■ 102 S	P2.2 ■ 90 S	P2.3 ■ 80 S	P3.1 ■ 81 S	P3.2 ■ 65 S	P3.3 ■ 55 S	P4.1 ■ 48 S	P4.2 ■ 41 S	P4.3 ■ 34 S	M1.1 ■ 82 S	M1.2 ■ 70 S
M2.1 ■ 73 S	M2.2 ■ 60 S	M3.1 ■ 58 S	M3.2 ■ 50 S	K1.1 ■ 80 T	K1.2 ■ 59 T	K1.3 ■ 44 T	K2.1 ■ 86 T	K2.2 ■ 70 T	K2.3 ■ 56 T	K3.1 ■ 76 T	K3.2 ■ 58 T	K3.3 ■ 47 T	K4.1 ■ 71 T
K4.2 ■ 53 T	K4.3 ■ 39 T	K4.4 ■ 33 T	K4.5 ■ 28 T	K5.1 ■ 80 T	K5.2 ■ 60 T	K5.3 ■ 46 T	N1.1 ■ 200 V	N1.2 ■ 150 V	N1.3 ■ 100 V	N2.1 ■ 172 V	N2.2 ■ 155 V	N2.3 ■ 112 V	N3.1 ■ 423 V
N3.2 ■ 250 V	N3.3 ■ 125 V	N4.1 ■ 60 X	N4.2 ■ 100 V	S1.1 ■ 55 T	S1.2 ■ 45 T	S1.3 ■ 35 S	S2.1 ■ 53 S	S2.2 ■ 42 S	S3.1 ■ 40 S	S3.2 ■ 30 S	S4.1 ■ 31 S	S4.2 ■ 24 S	H1.1 ■ 56 S
H2.1 ■ 33 S	H2.2 ■ 36 S	H3.1 ■ 37 S	H3.2 ■ 30 S										

DCON MS v toleranci h6.

Produkt	DC	DC	LCF	OAL	DCON MS
	(mm)	(inch)	(mm)	(mm)	(mm)
R60116.0	6.00	0.2362	16.0	50.0	6.00
R601110.0	10.00	0.3937	25.0	70.0	10.00
R601116.0	16.00	0.6299	26.0	90.0	16.00



R7131



Monolitní karbidový stupňovitý vrták s vnitřním chlazením, Povlak TiAIN

Univerzální nástroj pro vrtání a zahloubení otvorů pro standardní metrické závity. Vrtání a zahloubení v jedné operaci snižuje čas operace. Vrcholový úhel vrtáku 140° a zahloubení 90°. Povlak TiAIN zvyšuje produktivitu a prodlužuje životnost. Vhodný pro širokou oblast obráběných materiálů.

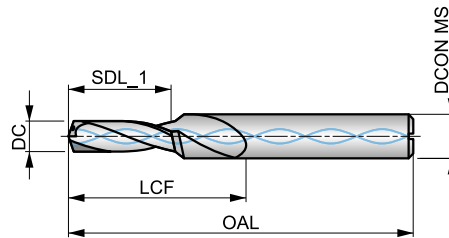

HM	DORMER	3xD
90°	TiAIN	DIN 6535HA
λ 20-35°	R	
DC m7		

Skupiny obráběných materiálů, startovní řezná rychlost (Vc m/min) a kód posuvu. Tabulku s posuvem na otáčku naleznete od strany 65.

P1.1 ■ 139 W	P1.2 ■ 156 W	P1.3 ■ 161 W	P2.1 ■ 119 W	P2.2 ■ 105 W	P2.3 ■ 93 V	P3.1 ■ 96 V	P3.2 ■ 77 V	P3.3 ■ 65 V	P4.1 ■ 57 V	P4.2 ■ 48 V	M1.1 ■ 62 V	M1.2 ■ 52 V	M2.1 ■ 55 V
M2.2 ■ 45 V	M3.1 ■ 47 V	M3.2 ■ 40 V	M3.3 ■ 36 U	M4.1 ■ 35 U	K1.1 ■ 90 W	K1.2 ■ 67 W	K1.3 ■ 50 W	K2.1 ■ 92 V	K2.2 ■ 75 V	K2.3 ■ 60 V	K3.1 ■ 82 V	K3.2 ■ 62 V	K3.3 ■ 50 V
K4.1 ■ 76 V	K4.2 ■ 57 V	K4.3 ■ 42 V	K4.4 ■ 36 V	K4.5 ■ 30 V	K5.1 ■ 86 V	K5.2 ■ 64 V	K5.3 ■ 50 V	N1.1 ■ 250 W	N1.2 ■ 188 W	N1.3 ■ 125 W	N2.1 ■ 308 V	N2.2 ■ 277 V	N2.3 ■ 200 V
N3.1 ■ 373 W	N3.2 ■ 220 W	N3.3 ■ 110 W											

DCON MS v toleranci h6.

Produkt	DC (mm)	DC (inch)	SDL_1 (mm)	LCF (mm)	OAL (mm)	DCON MS (mm)	TDZ
R71313.3	3.30	0.1299	11.40	20.0	66.0	6.00	M4
R71314.2	4.20	0.1654	13.60	24.0	66.0	6.00	M5
R71315.0	5.00	0.1969	16.50	28.0	79.0	8.00	M6
R71316.8	6.80	0.2677	21.00	34.0	89.0	10.00	M8
R71318.5	8.50	0.3346	25.50	47.0	102.0	12.00	M10
R713110.2	10.20	0.4016	30.00	55.0	107.0	14.00	M12
R713110.4	10.40	0.4094	30.00	55.0	107.0	14.00	M12



R120



Monolitní karbidový navrtávák, Leštěný

Navrtávák s velkou odolností proti opotřebení pro vysokou produktivitu a dlouhou životnost. Vrcholový úhel 120° a konstrukce se 4 fazetkami napomáhá vystředění a snižuje řezné síly. Vhodný pro vrtání tvrdých a abrazivních materiálů. Pro použití na CNC strojích.

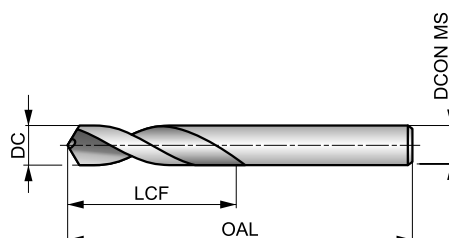

HM	DIN 6539	2.5xD
120°	Bright	
λ 20-35°	R	DC h7

Skupiny obráběných materiálů, startovní řezná rychlost (Vc m/min) a kód posuvu. Tabulku s posuvem na otáčku naleznete od strany 65.

P1.1 □99 S	P1.2 □111 S	P1.3 □115 S	P2.1 □85 S	P2.2 □75 S	P2.3 □66 S	P3.1 □66 S	P3.2 □53 S	P3.3 □45 S	P4.1 □40 S	P4.2 □34 S	P4.3 □27 S	K1.1 □75 U	K1.2 □56 U
K1.3 □42 U	K2.1 □68 U	K2.2 □55 U	K2.3 □44 U	K3.1 □60 U	K3.2 □46 U	K3.3 □37 U	K4.1 □55 U	K4.2 □42 U	K4.3 □31 U	K4.4 □26 U	K4.5 □22 U	K5.1 □63 U	K5.2 □47 U
K5.3 □37 U	N1.1 ■200 W	N1.2 ■150 W	N1.3 □100 W	N2.1 □172 W	N2.2 □155 W	N2.3 □112 W	N3.1 □466 W	N3.2 □275 W	N3.3 ■138 W	N4.1 ■60 U	N4.2 ■100 U	S1.1 ■45 T	S1.2 □35 T
S1.3 □25 T	S2.1 □40 T	S2.2 □28 T	S3.1 □30 T	S3.2 □20 T	S4.1 □23 T	S4.2 □16 T	H1.1 □56 S	H2.1 □33 S	H2.2 □36 S	H3.1 □37 S	H3.2 □30 S		

Produkt	DC	DC	LCF	OAL	DCON MS
	(mm)	(inch)			
R1201.0	1.00	0.0394	6.0	26.0	1.00
R1201.1	1.10	0.0433	7.0	28.0	1.10
R1201.2	1.20	0.0472	8.0	30.0	1.20
R1201.3	1.30	0.0512	8.0	30.0	1.30
R1201.4	1.40	0.0551	9.0	32.0	1.40
R1201.5	1.50	0.0591	9.0	32.0	1.50
R1201.6	1.60	0.0630	10.0	34.0	1.60
R1201.7	1.70	0.0669	10.0	34.0	1.70
R1201.8	1.80	0.0709	11.0	36.0	1.80
R1201.9	1.90	0.0748	11.0	36.0	1.90
R1202.0	2.00	0.0787	12.0	38.0	2.00
R1202.1	2.10	0.0827	12.0	38.0	2.10
R1202.2	2.20	0.0866	13.0	40.0	2.20
R1202.3	2.30	0.0906	13.0	40.0	2.30
R1202.4	2.40	0.0945	14.0	43.0	2.40
R1202.5	2.50	0.0984	14.0	43.0	2.50
R1202.6	2.60	0.1024	14.0	43.0	2.60
R1202.7	2.70	0.1063	16.0	46.0	2.70
R1202.8	2.80	0.1102	16.0	46.0	2.80
R1202.9	2.90	0.1142	16.0	46.0	2.90
R1203.0	3.00	0.1181	16.0	46.0	3.00
R1203.1	3.10	0.1220	18.0	49.0	3.10
R1203.2	3.20	0.1260	18.0	49.0	3.20
R1203.3	3.30	0.1299	18.0	49.0	3.30
R1203.4	3.40	0.1339	20.0	52.0	3.40
R1203.5	3.50	0.1378	20.0	52.0	3.50

Produkt	DC	DC	LCF	OAL	DCON MS
	(mm)	(inch)			
R1203.6	3.60	0.1417	20.0	52.0	3.60
R1203.7	3.70	0.1457	20.0	52.0	3.70
R1203.8	3.80	0.1496	22.0	55.0	3.80
R1203.9	3.90	0.1535	22.0	55.0	3.90
R1204.0	4.00	0.1575	22.0	55.0	4.00
R1204.1	4.10	0.1614	22.0	55.0	4.10
R1204.2	4.20	0.1654	22.0	55.0	4.20
R1204.3	4.30	0.1693	24.0	58.0	4.30
R1204.4	4.40	0.1732	24.0	58.0	4.40
R1204.5	4.50	0.1772	24.0	58.0	4.50
R1204.6	4.60	0.1811	24.0	58.0	4.60
R1204.7	4.70	0.1850	24.0	58.0	4.70
R1204.8	4.80	0.1890	26.0	62.0	4.80
R1204.9	4.90	0.1929	26.0	62.0	4.90
R1205.0	5.00	0.1969	26.0	62.0	5.00
R1205.1	5.10	0.2008	26.0	62.0	5.10
R1205.2	5.20	0.2047	26.0	62.0	5.20
R1205.3	5.30	0.2087	26.0	62.0	5.30
R1205.4	5.40	0.2126	28.0	66.0	5.40
R1205.5	5.50	0.2165	28.0	66.0	5.50
R1205.6	5.60	0.2205	28.0	66.0	5.60
R1205.7	5.70	0.2244	28.0	66.0	5.70
R1205.8	5.80	0.2283	28.0	66.0	5.80
R1205.9	5.90	0.2323	28.0	66.0	5.90
R1206.0	6.00	0.2362	28.0	66.0	6.00
R1206.1	6.10	0.2402	31.0	70.0	6.10



Produkt	DC	DC	LCF	OAL	DCON MS
	(mm)	(inch)	(mm)	(mm)	(mm)
R1206.2	6.20	0.2441	31.0	70.0	6.20
R1206.3	6.30	0.2480	31.0	70.0	6.30
R1206.4	6.40	0.2520	31.0	70.0	6.40
R1206.5	6.50	0.2559	31.0	70.0	6.50
R1206.6	6.60	0.2598	31.0	70.0	6.60
R1206.7	6.70	0.2638	31.0	70.0	6.70
R1206.8	6.80	0.2677	34.0	74.0	6.80
R1206.9	6.90	0.2717	34.0	74.0	6.90
R1207.0	7.00	0.2756	34.0	74.0	7.00
R1207.1	7.10	0.2795	34.0	74.0	7.10
R1207.2	7.20	0.2835	34.0	74.0	7.20
R1207.3	7.30	0.2874	34.0	74.0	7.30
R1207.4	7.40	0.2913	34.0	74.0	7.40
R1207.5	7.50	0.2953	34.0	74.0	7.50
R1207.6	7.60	0.2992	37.0	79.0	7.60
R1207.7	7.70	0.3031	37.0	79.0	7.70
R1207.8	7.80	0.3071	37.0	79.0	7.80
R1207.9	7.90	0.3110	37.0	79.0	7.90
R1208.0	8.00	0.3150	37.0	79.0	8.00
R1208.1	8.10	0.3189	37.0	79.0	8.10
R1208.2	8.20	0.3228	37.0	79.0	8.20
R1208.3	8.30	0.3268	37.0	79.0	8.30

Produkt	DC	DC	LCF	OAL	DCON MS
	(mm)	(inch)	(mm)	(mm)	(mm)
R1208.4	8.40	0.3307	37.0	79.0	8.40
R1208.5	8.50	0.3346	37.0	79.0	8.50
R1208.6	8.60	0.3386	40.0	84.0	8.60
R1208.7	8.70	0.3425	40.0	84.0	8.70
R1208.8	8.80	0.3465	40.0	84.0	8.80
R1208.9	8.90	0.3504	40.0	84.0	8.90
R1208.9	9.00	0.3543	40.0	84.0	9.00
R1209.1	9.10	0.3583	40.0	84.0	9.10
R1209.2	9.20	0.3622	40.0	84.0	9.20
R1209.3	9.30	0.3661	40.0	84.0	9.30
R1209.4	9.40	0.3701	40.0	84.0	9.40
R1209.5	9.50	0.3740	40.0	84.0	9.50
R1209.6	9.60	0.3780	43.0	89.0	9.60
R1209.7	9.70	0.3819	43.0	89.0	9.70
R1209.8	9.80	0.3858	43.0	89.0	9.80
R1209.9	9.90	0.3898	43.0	89.0	9.90
R12010.0	10.00	0.3937	43.0	89.0	10.00
R12010.2	10.20	0.4016	43.0	89.0	10.20
R12010.5	10.50	0.4134	43.0	89.0	10.50
R12011.0	11.00	0.4331	47.0	95.0	11.00
R12011.5	11.50	0.4528	47.0	95.0	11.50
R12012.0	12.00	0.4724	51.0	102.0	12.00



R100



Monolitní karbidový vrták, Leštěný

Vrták s velkou odolností proti opotřebení pro vysokou produktivitu a dlouhou životnost. Vrcholový úhel 120° a konstrukce se 4 fazetkami napomáhá vystředění a snižuje řezné síly. Pro použití na CNC strojích.

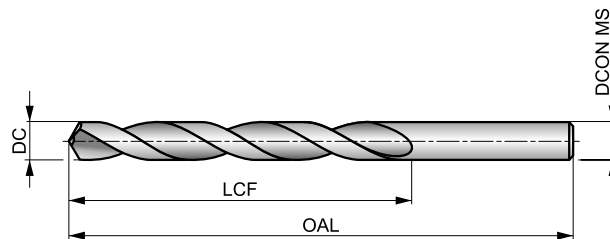

HM	DIN 338	4×D
120°	Bright	
λ 20-35°	R	DC h7

Skupiny obráběných materiálů, startovní řezná rychlost (Vc m/min) a kód posuvu. Tabulku s posuvem na otáčku naleznete od strany 65.

P1.1 □99 S	P1.2 □111 S	P1.3 □115 S	P2.1 □85 S	P2.2 □75 S	P2.3 □66 S	P3.1 □66 S	P3.2 □53 S	P3.3 □45 S	P4.1 □40 S	P4.2 □34 S	P4.3 □27 S	K1.1 □75 T	K1.2 □56 T
K1.3 □42 T	K2.1 □68 T	K2.2 □55 T	K2.3 □44 T	K3.1 □60 T	K3.2 □46 T	K3.3 □37 T	K4.1 □55 T	K4.2 □42 T	K4.3 □31 T	K4.4 □26 T	K4.5 □22 T	K5.1 □63 T	K5.2 □47 T
K5.3 □37 T	N1.1 □200 V	N1.2 □150 V	N1.3 □100 V	N2.1 □172 V	N2.2 □155 V	N2.3 □112 V	N3.1 ■423 V	N3.2 ■250 V	N4.1 ■60 X	N4.2 ■100 V	H1.1 □56 S	H2.1 □33 S	H2.2 □36 S
H3.1 □37 S	H3.2 □30 S												

Produkt	DC	DC	LCF	OAL	DC ON MS
	(mm)	(inch)			
R1001.0	1.00	0.0394	12.0	34.0	1.00
R1001.1	1.10	0.0433	14.0	36.0	1.10
R1001.2	1.20	0.0472	16.0	38.0	1.20
R1001.3	1.30	0.0512	16.0	38.0	1.30
R1001.4	1.40	0.0551	18.0	40.0	1.40
R1001.5	1.50	0.0591	18.0	40.0	1.50
R1001.6	1.60	0.0630	20.0	43.0	1.60
R1001.7	1.70	0.0669	20.0	43.0	1.70
R1001.8	1.80	0.0709	22.0	46.0	1.80
R1001.9	1.90	0.0748	22.0	46.0	1.90
R1002.0	2.00	0.0787	24.0	49.0	2.00
R1002.1	2.10	0.0827	24.0	49.0	2.10
R1002.2	2.20	0.0866	27.0	53.0	2.20
R1002.3	2.30	0.0906	27.0	53.0	2.30
R1002.4	2.40	0.0945	30.0	57.0	2.40
R1002.5	2.50	0.0984	30.0	57.0	2.50
R1002.6	2.60	0.1024	30.0	57.0	2.60
R1002.7	2.70	0.1063	33.0	61.0	2.70
R1002.8	2.80	0.1102	33.0	61.0	2.80
R1002.9	2.90	0.1142	33.0	61.0	2.90
R1003.0	3.00	0.1181	33.0	61.0	3.00
R1003.1	3.10	0.1220	36.0	65.0	3.10
R1003.2	3.20	0.1260	36.0	65.0	3.20
R1003.3	3.30	0.1299	36.0	65.0	3.30
R1003.4	3.40	0.1339	39.0	70.0	3.40
R1003.5	3.50	0.1378	39.0	70.0	3.50

Produkt	DC	DC	LCF	OAL	DC ON MS
	(mm)	(inch)			
R1003.6	3.60	0.1417	39.0	70.0	3.60
R1003.7	3.70	0.1457	39.0	70.0	3.70
R1003.8	3.80	0.1496	43.0	75.0	3.80
R1003.9	3.90	0.1535	43.0	75.0	3.90
R1004.0	4.00	0.1575	43.0	75.0	4.00
R1004.1	4.10	0.1614	43.0	75.0	4.10
R1004.2	4.20	0.1654	43.0	75.0	4.20
R1004.3	4.30	0.1693	47.0	80.0	4.30
R1004.4	4.40	0.1732	47.0	80.0	4.40
R1004.5	4.50	0.1772	47.0	80.0	4.50
R1004.6	4.60	0.1811	47.0	80.0	4.60
R1004.7	4.70	0.1850	47.0	80.0	4.70
R1004.8	4.80	0.1890	52.0	86.0	4.80
R1004.9	4.90	0.1929	52.0	86.0	4.90
R1005.0	5.00	0.1969	52.0	86.0	5.00
R1005.1	5.10	0.2008	52.0	86.0	5.10
R1005.2	5.20	0.2047	52.0	86.0	5.20
R1005.3	5.30	0.2087	52.0	86.0	5.30
R1005.4	5.40	0.2126	57.0	93.0	5.40
R1005.5	5.50	0.2165	57.0	93.0	5.50
R1005.6	5.60	0.2205	57.0	93.0	5.60
R1005.7	5.70	0.2244	57.0	93.0	5.70
R1005.8	5.80	0.2283	57.0	93.0	5.80
R1005.9	5.90	0.2323	57.0	93.0	5.90
R1006.0	6.00	0.2362	57.0	93.0	6.00
R1006.1	6.10	0.2402	63.0	101.0	6.10



Produkt	DC	DC	LCF	OAL	DCON MS
	(mm)	(inch)	(mm)	(mm)	(mm)
R1006.2	6.20	0.2441	63.0	101.0	6.20
R1006.3	6.30	0.2480	63.0	101.0	6.30
R1006.4	6.40	0.2520	63.0	101.0	6.40
R1006.5	6.50	0.2559	63.0	101.0	6.50
R1006.6	6.60	0.2598	63.0	101.0	6.60
R1006.7	6.70	0.2638	63.0	101.0	6.70
R1006.8	6.80	0.2677	69.0	109.0	6.80
R1006.9	6.90	0.2717	69.0	109.0	6.90
R1007.0	7.00	0.2756	69.0	109.0	7.00
R1007.1	7.10	0.2795	69.0	109.0	7.10
R1007.2	7.20	0.2835	69.0	109.0	7.20
R1007.3	7.30	0.2874	69.0	109.0	7.30
R1007.4	7.40	0.2913	69.0	109.0	7.40
R1007.5	7.50	0.2953	69.0	109.0	7.50
R1007.6	7.60	0.2992	75.0	117.0	7.60
R1007.7	7.70	0.3031	75.0	117.0	7.70
R1007.8	7.80	0.3071	75.0	117.0	7.80
R1007.9	7.90	0.3110	75.0	117.0	7.90
R1008.0	8.00	0.3150	75.0	117.0	8.00
R1008.1	8.10	0.3189	75.0	117.0	8.10
R1008.2	8.20	0.3228	75.0	117.0	8.20
R1008.3	8.30	0.3268	75.0	117.0	8.30
R1008.4	8.40	0.3307	75.0	117.0	8.40

Produkt	DC	DC	LCF	OAL	DCON MS
	(mm)	(inch)	(mm)	(mm)	(mm)
R1008.5	8.50	0.3346	75.0	117.0	8.50
R1008.6	8.60	0.3386	81.0	125.0	8.60
R1008.7	8.70	0.3425	81.0	125.0	8.70
R1008.8	8.80	0.3465	81.0	125.0	8.80
R1008.9	8.90	0.3504	81.0	125.0	8.90
R1009.0	9.00	0.3543	81.0	125.0	9.00
R1009.1	9.10	0.3583	81.0	125.0	9.10
R1009.2	9.20	0.3622	81.0	125.0	9.20
R1009.3	9.30	0.3661	81.0	125.0	9.30
R1009.4	9.40	0.3701	81.0	125.0	9.40
R1009.5	9.50	0.3740	81.0	125.0	9.50
R1009.6	9.60	0.3780	87.0	133.0	9.60
R1009.7	9.70	0.3819	87.0	133.0	9.70
R1009.8	9.80	0.3858	87.0	133.0	9.80
R1009.9	9.90	0.3898	87.0	133.0	9.90
R10010.0	10.00	0.3937	87.0	133.0	10.00
R10010.2	10.20	0.4016	87.0	133.0	10.20
R10010.5	10.50	0.4134	87.0	133.0	10.50
R10011.0	11.00	0.4331	94.0	142.0	11.00
R10011.5	11.50	0.4528	94.0	142.0	11.50
R10012.0	12.00	0.4724	101.0	151.0	12.00
R10013.0	13.00	0.5118	101.0	151.0	13.00
R10014.0	14.00	0.5512	108.0	160.0	14.00



R520



CDX Krátký karbidový vrták, Povlakovaný TiN

Produktivní vrták pro kvalitní a přesné otvory, vhodný pro vysoké řezné rychlosti a velké posuvy (tolerance otvorů H8). Vrcholový úhel 130° usnadňuje vystředění a snižuje řezné síly. Povlak TiN zvyšuje produktivitu a prodlužuje životnost. Vhodný pro CNC stroje a širokou oblast obráběných materiálů.

CDX

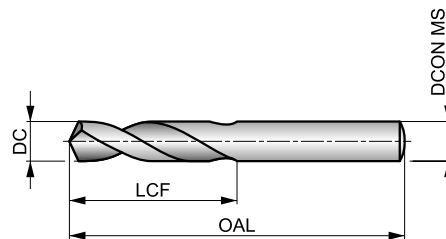

HM	DIN 6539	2.5×D
130°	TiN	
λ 20-35°	R	DC h7

Skupiny obráběných materiálů, startovní řezná rychlost (Vc m/min) a kód posuvu. Tabulku s posuvem na otáčku naleznete od strany 65.

P1.1 ■ 119 X	P1.2 ■ 134 X	P1.3 ■ 138 X	P2.1 ■ 102 X	P2.2 ■ 90 X	P2.3 ■ 80 X	P3.1 ■ 81 X	P3.2 ■ 65 X	P3.3 ■ 55 X	P4.1 ■ 48 X	P4.2 ■ 41 X	P4.3 ■ 34 W	M1.1 ■ 69 W	M1.2 ■ 58 W
M2.1 ■ 61 W	M2.2 ■ 50 W	K1.1 ■ 90 Y	K1.2 ■ 67 Y	K1.3 ■ 50 Y	K2.1 ■ 80 X	K2.2 ■ 65 X	K2.3 ■ 52 X	K3.1 ■ 71 X	K3.2 ■ 54 X	K3.3 ■ 44 X	K4.1 ■ 66 X	K4.2 ■ 49 X	K4.3 ■ 36 X
K4.4 ■ 31 X	K4.5 ■ 26 X	K5.1 ■ 74 X	K5.2 ■ 56 X	K5.3 ■ 43 X	N1.1 ■ 225 Z	N1.2 ■ 169 Z	N1.3 ■ 113 Z	N2.1 ■ 231 Y	N2.2 ■ 208 Y	N2.3 ■ 150 Y	N4.1 ■ 75 Z	N4.2 ■ 115 V	S1.1 ■ 60 W
S1.2 ■ 45 V	S1.3 ■ 35 U	H1.1 ■ 65 U	H2.1 ■ 38 U	H2.2 ■ 36 T	H3.1 ■ 43 U	H3.2 ■ 35 U							

DCON MS v toleranci h7.

Produkt	DC (inch)	DC (mm)	DC (inch)	LCF (mm)	OAL (mm)	DCON MS (mm)
R5203.0	–	3.00	0.1181	16.0	46.0	3.00
R5203.1	–	3.10	0.1220	18.0	49.0	3.10
R5201/8	1/8	3.18	0.1252	18.0	49.0	3.18
R5203.2	–	3.20	0.1260	18.0	49.0	3.20
R5203.3	–	3.30	0.1299	18.0	49.0	3.30
R5203.4	–	3.40	0.1339	20.0	52.0	3.40
R5203.5	–	3.50	0.1378	20.0	52.0	3.50
R5203.6	–	3.60	0.1417	20.0	52.0	3.60
R5203.7	–	3.70	0.1457	20.0	52.0	3.70
R5203.8	–	3.80	0.1496	22.0	55.0	3.80
R5203.9	–	3.90	0.1535	22.0	55.0	3.90
R5204.0	–	4.00	0.1575	22.0	55.0	4.00
R5204.1	–	4.10	0.1614	22.0	55.0	4.10
R5204.2	–	4.20	0.1654	22.0	55.0	4.20
R5204.3	–	4.30	0.1693	24.0	58.0	4.30
R5204.4	–	4.40	0.1732	24.0	58.0	4.40
R5204.5	–	4.50	0.1772	24.0	58.0	4.50
R5204.6	–	4.60	0.1811	24.0	58.0	4.60
R5204.7	–	4.70	0.1850	24.0	58.0	4.70
R5204.8	–	4.80	0.1890	26.0	62.0	4.80
R5204.9	–	4.90	0.1929	26.0	62.0	4.90
R5205.0	–	5.00	0.1969	26.0	62.0	5.00
R5205.1	–	5.10	0.2008	26.0	62.0	5.10
R5205.2	–	5.20	0.2047	26.0	62.0	5.20
R5205.3	–	5.30	0.2087	26.0	62.0	5.30

Produkt	DC (inch)	DC (mm)	DC (inch)	LCF (mm)	OAL (mm)	DCON MS (mm)
R5205.4	–	5.40	0.2126	28.0	66.0	5.40
R5205.5	–	5.50	0.2165	28.0	66.0	5.50
R5205.6	–	5.60	0.2205	28.0	66.0	5.60
R5205.7	–	5.70	0.2244	28.0	66.0	5.70
R5205.8	–	5.80	0.2283	28.0	66.0	5.80
R5205.9	–	5.90	0.2323	28.0	66.0	5.90
R5206.0	–	6.00	0.2362	28.0	66.0	6.00
R5206.1	–	6.10	0.2402	31.0	70.0	6.10
R5206.2	–	6.20	0.2441	31.0	70.0	6.20
R5206.3	–	6.30	0.2480	31.0	70.0	6.30
R5201/4	1/4	6.35	0.2500	31.0	70.0	6.35
R5206.4	–	6.40	0.2520	31.0	70.0	6.40
R5206.5	–	6.50	0.2559	31.0	70.0	6.50
R5206.6	–	6.60	0.2598	31.0	70.0	6.60
R5206.7	–	6.70	0.2638	31.0	70.0	6.70
R5206.8	–	6.80	0.2677	34.0	74.0	6.80
R5206.9	–	6.90	0.2717	34.0	74.0	6.90
R5207.0	–	7.00	0.2756	34.0	74.0	7.00
R5207.1	–	7.10	0.2795	34.0	74.0	7.10
R5207.2	–	7.20	0.2835	34.0	74.0	7.20
R5207.3	–	7.30	0.2874	34.0	74.0	7.30
R5207.4	–	7.40	0.2913	34.0	74.0	7.40
R5207.5	–	7.50	0.2953	34.0	74.0	7.50
R5207.6	–	7.60	0.2992	37.0	79.0	7.60
R5207.7	–	7.70	0.3031	37.0	79.0	7.70



Produkt	DC	DC	DC	LCF	OAL	D CON MS
	(inch)	(mm)	(inch)	(mm)	(mm)	(mm)
R5207.8	–	7.80	0.3071	37.0	79.0	7.80
R5207.9	–	7.90	0.3110	37.0	79.0	7.90
R5205/16	5/16	7.94	0.3126	37.0	79.0	7.94
R5208.0	–	8.00	0.3150	37.0	79.0	8.00
R5208.1	–	8.10	0.3189	37.0	79.0	8.10
R5208.2	–	8.20	0.3228	37.0	79.0	8.20
R5208.3	–	8.30	0.3268	37.0	79.0	8.30
R5208.4	–	8.40	0.3307	37.0	79.0	8.40
R5208.5	–	8.50	0.3346	37.0	79.0	8.50
R5208.6	–	8.60	0.3386	40.0	84.0	8.60
R5208.7	–	8.70	0.3425	40.0	84.0	8.70
R5208.8	–	8.80	0.3465	40.0	84.0	8.80
R5208.9	–	8.90	0.3504	40.0	84.0	8.90
R5209.0	–	9.00	0.3543	40.0	84.0	9.00
R5209.1	–	9.10	0.3583	40.0	84.0	9.10
R5209.2	–	9.20	0.3622	40.0	84.0	9.20
R5209.3	–	9.30	0.3661	40.0	84.0	9.30
R5209.4	–	9.40	0.3701	40.0	84.0	9.40
R5209.5	–	9.50	0.3740	40.0	84.0	9.50
R5203/8	3/8	9.52	0.3748	43.0	89.0	9.52
R5209.6	–	9.60	0.3780	43.0	89.0	9.60
R5209.7	–	9.70	0.3819	43.0	89.0	9.70
R5209.8	–	9.80	0.3858	43.0	89.0	9.80
R5209.9	–	9.90	0.3898	43.0	89.0	9.90

Produkt	DC	DC	DC	LCF	OAL	D CON MS
	(inch)	(mm)	(inch)	(mm)	(mm)	(mm)
R52010.0	–	10.00	0.3937	43.0	89.0	10.00
R52010.1	–	10.10	0.3976	43.0	89.0	10.10
R52010.2	–	10.20	0.4016	43.0	89.0	10.20
R52010.3	–	10.30	0.4055	43.0	89.0	10.30
R52010.4	–	10.40	0.4094	43.0	89.0	10.40
R52010.5	–	10.50	0.4134	43.0	89.0	10.50
R52011.0	–	11.00	0.4331	47.0	95.0	11.00
R5207/16	7/16	11.11	0.4374	47.0	95.0	11.11
R52011.2	–	11.20	0.4409	47.0	95.0	11.20
R52011.5	–	11.50	0.4528	47.0	95.0	11.50
R52012.0	–	12.00	0.4724	51.0	102.0	12.00
R52012.5	–	12.50	0.4921	51.0	102.0	12.50
R5201/2	1/2	12.70	0.5000	51.0	102.0	12.70
R52013.0	–	13.00	0.5118	51.0	102.0	13.00
R52013.5	–	13.50	0.5315	54.0	107.0	13.50
R52014.0	–	14.00	0.5512	54.0	107.0	14.00
R52014.2	–	14.20	0.5591	56.0	111.0	14.20
R52014.25	–	14.25	0.5610	56.0	111.0	14.25
R52014.5	–	14.50	0.5709	56.0	111.0	14.50
R52015.0	–	15.00	0.5906	56.0	111.0	15.00
R52015.1	–	15.10	0.5945	58.0	115.0	15.10
R5205/8	5/8	15.88	0.6252	58.0	115.0	15.88
R52016.0	–	16.00	0.6299	58.0	115.0	16.00
R52016.5	–	16.50	0.6496	60.0	119.0	16.50



R510



CDX Monolitní karbidový vrták, Povlak TiN

Produktivní vrták pro kvalitní a přesné otvory, vhodný pro vysoké řezné rychlosti a velké posuvy (tolerance otvorů H10). Vrcholový úhel 130° usnadňuje vystředění a snižuje řezné síly. Povlak TiN zvyšuje produktivitu a prodlužuje životnost. Vhodný pro CNC stroje a širokou oblast obráběných materiálů.

CDX

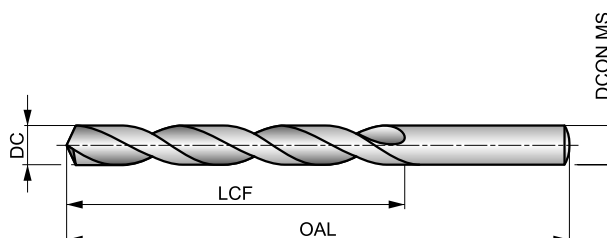

HM	DIN 338	4xD
130°	TiN	
λ 20-35°	R	DC h7

Skupiny obráběných materiálů, startovní řezná rychlost (Vc m/min) a kód posuvu. Tabulku s posuvem na otáčku naleznete od strany 65.

P1.1 ■ 119 W	P1.2 ■ 134 W	P1.3 ■ 138 W	P2.1 ■ 102 W	P2.2 ■ 90 W	P2.3 ■ 80 V	P3.1 ■ 81 W	P3.2 ■ 65 W	P3.3 ■ 55 V	P4.1 ■ 48 W	P4.2 ■ 41 V	P4.3 ■ 34 V	M1.1 ■ 69 V	M1.2 ■ 58 V
M2.1 ■ 61 V	M2.2 ■ 50 V	K1.1 ■ 90 X	K1.2 ■ 67 X	K1.3 ■ 50 X	K2.1 ■ 80 W	K2.2 ■ 65 W	K2.3 ■ 52 W	K3.1 ■ 71 W	K3.2 ■ 54 W	K3.3 ■ 44 W	K4.1 ■ 66 W	K4.2 ■ 49 W	K4.3 ■ 36 W
K4.4 ■ 31 W	K4.5 ■ 26 W	K5.1 ■ 74 W	K5.2 ■ 56 W	K5.3 ■ 43 W	N1.1 ■ 225 Y	N1.2 ■ 169 Y	N1.3 ■ 113 Y	N2.1 ■ 231 X	N2.2 ■ 208 X	N2.3 ■ 150 X	N4.1 ■ 75 X	N4.2 ■ 115 V	S1.1 ■ 45 V
H1.1 ■ 65 T	H2.1 ■ 38 T	H2.2 ■ 36 S	H3.1 ■ 43 T	H3.2 ■ 35 T									

DCON MS v toleranci h7.

Produkt	DC (inch)	DC (mm)	DC (inch)	LCF (mm)	OAL (mm)	DCON MS (mm)
R5103.0	–	3.00	0.1181	33.0	61.0	3.00
R5101/8	1/8	3.18	0.1252	36.0	65.0	3.18
R5103.2	–	3.20	0.1260	36.0	65.0	3.20
R5103.3	–	3.30	0.1299	36.0	65.0	3.30
R5103.4	–	3.40	0.1339	39.0	70.0	3.40
R5103.5	–	3.50	0.1378	39.0	70.0	3.50
R5103.7	–	3.70	0.1457	39.0	70.0	3.70
R5103.9	–	3.90	0.1535	43.0	75.0	3.90
R5104.0	–	4.00	0.1575	43.0	75.0	4.00
R5104.1	–	4.10	0.1614	43.0	75.0	4.10
R5104.2	–	4.20	0.1654	43.0	75.0	4.20
R5104.3	–	4.30	0.1693	47.0	80.0	4.30
R5104.5	–	4.50	0.1772	47.0	80.0	4.50
R5104.6	–	4.60	0.1811	47.0	80.0	4.60
R5104.7	–	4.70	0.1850	47.0	80.0	4.70
R5103/16	3/16	4.76	0.1874	52.0	86.0	4.76
R5104.9	–	4.90	0.1929	52.0	86.0	4.90
R5105.0	–	5.00	0.1969	52.0	86.0	5.00
R5105.1	–	5.10	0.2008	52.0	86.0	5.10
R5105.5	–	5.50	0.2165	57.0	93.0	5.50
R5105.6	–	5.60	0.2205	57.0	93.0	5.60
R5105.7	–	5.70	0.2244	57.0	93.0	5.70
R5106.0	–	6.00	0.2362	57.0	93.0	6.00
R5101/4	1/4	6.35	0.2500	63.0	101.0	6.35
R5106.5	–	6.50	0.2559	63.0	101.0	6.50

Produkt	DC (inch)	DC (mm)	DC (inch)	LCF (mm)	OAL (mm)	DCON MS (mm)
R5106.6	–	6.60	0.2598	63.0	101.0	6.60
R5106.8	–	6.80	0.2677	69.0	109.0	6.80
R5106.9	–	6.90	0.2717	69.0	109.0	6.90
R5107.0	–	7.00	0.2756	69.0	109.0	7.00
R5107.3	–	7.30	0.2874	69.0	109.0	7.30
R5107.4	–	7.40	0.2913	69.0	109.0	7.40
R5107.5	–	7.50	0.2953	69.0	109.0	7.50
R5107.8	–	7.80	0.3071	75.0	117.0	7.80
R5107.9	–	7.90	0.3110	75.0	117.0	7.90
R5105/16	5/16	7.94	0.3126	75.0	117.0	7.94
R5108.0	–	8.00	0.3150	75.0	117.0	8.00
R5108.5	–	8.50	0.3346	75.0	117.0	8.50
R5108.7	–	8.70	0.3425	81.0	125.0	8.70
R5108.8	–	8.80	0.3465	81.0	125.0	8.80
R5109.0	–	9.00	0.3543	81.0	125.0	9.00
R5109.2	–	9.20	0.3622	81.0	125.0	9.20
R5109.3	–	9.30	0.3661	81.0	125.0	9.30
R5109.4	–	9.40	0.3701	81.0	125.0	9.40
R5109.5	–	9.50	0.3740	81.0	125.0	9.50
R5103/8	3/8	9.52	0.3748	87.0	133.0	9.52
R5109.9	–	9.90	0.3898	87.0	133.0	9.90
R51010.0	–	10.00	0.3937	87.0	133.0	10.00
R51010.2	–	10.20	0.4016	87.0	133.0	10.20
R51010.3	–	10.30	0.4055	87.0	133.0	10.30
R51010.4	–	10.40	0.4094	87.0	133.0	10.40



Produkt	DC	DC	DC	LCF	OAL	D CON MS
	(inch)	(mm)	(inch)	(mm)	(mm)	(mm)
R51010.5	–	10.50	0.4134	87.0	133.0	10.50
R51010.8	–	10.80	0.4252	94.0	142.0	10.80
R51011.0	–	11.00	0.4331	94.0	142.0	11.00
R5107/16	7/16	11.11	0.4374	94.0	142.0	11.11
R51011.2	–	11.20	0.4409	94.0	142.0	11.20
R51011.5	–	11.50	0.4528	94.0	142.0	11.50

Produkt	DC	DC	DC	LCF	OAL	D CON MS
	(inch)	(mm)	(inch)	(mm)	(mm)	(mm)
R51012.0	–	12.00	0.4724	101.0	151.0	12.00
R5101/2	1/2	12.70	0.5000	101.0	151.0	12.70
R51013.0	–	13.00	0.5118	101.0	151.0	13.00
R51014.0	–	14.00	0.5512	108.0	160.0	14.00
R51014.25	–	14.25	0.5610	114.0	169.0	14.25



R458



FORCE X Monolitní karbidový vrták 3xD, Povlakovaný TiAlN

Produktivní vrták pro kvalitní a přesné otvory, vhodný pro vysoké řezné rychlosti a velké posuvy (tolerance otvorů H9). Vrcholový úhel 140°, konstrukce se 4 fazetkami a spec. drážkou CTW pro snazší proniknutí do materiálu. Povlak TiAlN zvyšuje tvrdost povrchu nástroje a prodlužuje životnost.

FORCE X

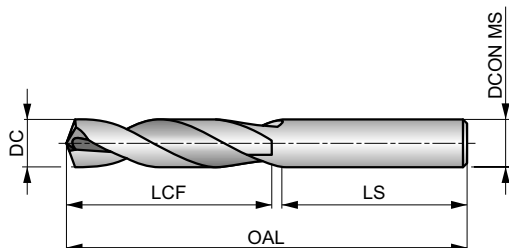

HM	DIN 6537K	3xD
140°	TiAlN	DIN 6535HA
CTW	DC m7	

Skupiny obráběných materiálů, startovní řezná rychlost (Vc m/min) a kód posuvu. Tabulku s posuvem na otáčku naleznete od strany 65.

P1.1 ■ 143 W	P1.2 ■ 160 W	P1.3 ■ 166 W	P2.1 ■ 122 W	P2.2 ■ 108 W	P2.3 ■ 95 V	P3.1 ■ 106 V	P3.2 ■ 86 V	P3.3 ■ 72 V	P4.1 ■ 63 V	P4.2 ■ 54 V	P4.3 ■ 44 U	M1.1 ■ 60 U	M1.2 ■ 51 U
M2.1 ■ 54 U	M2.2 ■ 44 U	M2.3 ■ 37 T	M3.1 ■ 33 T	M3.2 ■ 28 T	M3.3 ■ 26 T	M4.1 ■ 24 T	M4.2 ■ 21 T	K1.1 ■ 88 W	K1.2 ■ 65 W	K1.3 ■ 49 W	K2.1 ■ 78 V	K2.2 ■ 64 V	K2.3 ■ 51 V
K3.1 ■ 70 V	K3.2 ■ 54 V	K3.3 ■ 43 V	K4.1 ■ 65 V	K4.2 ■ 49 V	K4.3 ■ 36 V	K4.4 ■ 30 V	K4.5 ■ 26 V	K5.1 ■ 73 V	K5.2 ■ 55 V	K5.3 ■ 42 V	N1.1 ■ 200 W	N1.2 ■ 150 W	N1.3 ■ 100 W
N2.1 ■ 246 V	N2.2 ■ 222 V	N2.3 ■ 160 V	N3.1 ■ 298 V	N3.2 ■ 176 V	N3.3 ■ 88 V	S1.1 ■ 44 U	S1.2 ■ 36 U	S1.3 ■ 32 T	H1.1 ■ 45 U	H2.1 ■ 26 U	H2.2 ■ 24 U	H3.1 ■ 30 U	H3.2 ■ 24 U

DCON MS v toleranci h6.

Produkt	DC	DC	DC	LCF	OAL	LS	DCON MS
	(inch)	(mm)	(inch)	(mm)	(mm)	(mm)	(mm)
R4583.0	–	3.00	0.1181	20.0	62.0	36.0	6.00
R4583.1	–	3.10	0.1220	20.0	62.0	36.0	6.00
R4581/8	1/8	3.18	0.1250	20.0	62.0	36.0	6.00
R4583.2	–	3.20	0.1260	20.0	62.0	36.0	6.00
R458N30	N30	3.26	0.1283	20.0	62.0	36.0	6.00
R4583.3	–	3.30	0.1299	20.0	62.0	36.0	6.00
R4583.4	–	3.40	0.1339	20.0	62.0	36.0	6.00
R458N29	N29	3.45	0.1360	20.0	62.0	36.0	6.00
R4583.5	–	3.50	0.1378	20.0	62.0	36.0	6.00
R458N28	N28	3.57	0.1406	20.0	62.0	36.0	6.00
R4589/64	9/64	3.57	0.1406	20.0	62.0	36.0	6.00
R4583.6	–	3.60	0.1417	20.0	62.0	36.0	6.00
R458N27	N27	3.66	0.1441	20.0	62.0	36.0	6.00
R4583.7	–	3.70	0.1457	20.0	62.0	36.0	6.00
R4583.73	–	3.73	0.1469	24.0	66.0	36.0	6.00
R458N26	N26	3.73	0.1469	24.0	66.0	36.0	6.00
R458N25	N25	3.80	0.1496	24.0	66.0	36.0	6.00
R4583.8	–	3.80	0.1496	24.0	66.0	36.0	6.00
R458N24	N24	3.86	0.1520	24.0	66.0	36.0	6.00
R4583.9	–	3.90	0.1535	24.0	66.0	36.0	6.00
R458N23	N23	3.91	0.1539	24.0	66.0	36.0	6.00
R4585/32	5/32	3.97	0.1563	24.0	66.0	36.0	6.00
R458N22	N22	3.99	0.1571	24.0	66.0	36.0	6.00
R4584.0	–	4.00	0.1575	24.0	66.0	36.0	6.00
R458N21	N21	4.04	0.1591	24.0	66.0	36.0	6.00



Produkt	DC	DC	DC	LCF	OAL	LS	DCON MS
	(inch)	(mm)	(inch)	(mm)	(mm)	(mm)	(mm)
R458N20	N20	4.09	0.1610	24.0	66.0	36.0	6.00
R4584.1	–	4.10	0.1614	24.0	66.0	36.0	6.00
R4584.2	–	4.20	0.1654	24.0	66.0	36.0	6.00
R458N19	N19	4.22	0.1661	24.0	66.0	36.0	6.00
R4584.3	–	4.30	0.1693	24.0	66.0	36.0	6.00
R458N18	N18	4.31	0.1697	24.0	66.0	36.0	6.00
R45811/64	11/64	4.37	0.1719	24.0	66.0	36.0	6.00
R458N17	N17	4.39	0.1728	24.0	66.0	36.0	6.00
R4584.4	–	4.40	0.1732	24.0	66.0	36.0	6.00
R4584.5	–	4.50	0.1772	24.0	66.0	36.0	6.00
R458N16	N16	4.50	0.1772	24.0	66.0	36.0	6.00
R458N15	N15	4.57	0.1799	24.0	66.0	36.0	6.00
R4584.6	–	4.60	0.1811	24.0	66.0	36.0	6.00
R458N14	N14	4.62	0.1819	24.0	66.0	36.0	6.00
R458N13	N13	4.70	0.1850	24.0	66.0	36.0	6.00
R4584.7	–	4.70	0.1850	24.0	66.0	36.0	6.00
R4583/16	3/16	4.76	0.1875	28.0	66.0	36.0	6.00
R4584.8	–	4.80	0.1890	28.0	66.0	36.0	6.00
R458N12	N12	4.80	0.1890	28.0	66.0	36.0	6.00
R458N11	N11	4.85	0.1909	28.0	66.0	36.0	6.00
R4584.9	–	4.90	0.1929	28.0	66.0	36.0	6.00
R458N10	N10	4.92	0.1937	28.0	66.0	36.0	6.00
R458N9	N9	4.98	0.1961	28.0	66.0	36.0	6.00
R4585.0	–	5.00	0.1969	28.0	66.0	36.0	6.00
R458N8	N8	5.06	0.1992	28.0	66.0	36.0	6.00
R4585.1	–	5.10	0.2008	28.0	66.0	36.0	6.00
R458N7	N7	5.11	0.2010	28.0	66.0	36.0	6.00
R45813/64	13/64	5.16	0.2031	28.0	66.0	36.0	6.00
R458N6	N6	5.18	0.2039	28.0	66.0	36.0	6.00
R4585.2	–	5.20	0.2047	28.0	66.0	36.0	6.00
R458N5	N5	5.22	0.2055	28.0	66.0	36.0	6.00
R4585.3	–	5.30	0.2087	28.0	66.0	36.0	6.00
R458N4	N4	5.31	0.2091	28.0	66.0	36.0	6.00
R4585.4	–	5.40	0.2126	28.0	66.0	36.0	6.00
R458N3	N3	5.41	0.2130	28.0	66.0	36.0	6.00
R4585.5	–	5.50	0.2165	28.0	66.0	36.0	6.00
R4587/32	7/32	5.56	0.2188	28.0	66.0	36.0	6.00
R4585.6	–	5.60	0.2205	28.0	66.0	36.0	6.00
R458N2	N2	5.61	0.2209	28.0	66.0	36.0	6.00
R4585.7	–	5.70	0.2244	28.0	66.0	36.0	6.00
R458N1	N1	5.79	0.2280	28.0	66.0	36.0	6.00
R4585.8	–	5.80	0.2283	28.0	66.0	36.0	6.00
R4585.9	–	5.90	0.2323	28.0	66.0	36.0	6.00
R458A	A	5.94	0.2339	28.0	66.0	36.0	6.00
R45815/64	15/64	5.95	0.2344	28.0	66.0	36.0	6.00
R4586.0	–	6.00	0.2362	28.0	66.0	36.0	6.00
R458B	B	6.05	0.2380	34.0	79.0	36.0	8.00
R4586.1	–	6.10	0.2402	34.0	79.0	36.0	8.00
R458C	C	6.15	0.2421	34.0	79.0	36.0	8.00
R4586.2	–	6.20	0.2441	34.0	79.0	36.0	8.00
R458D	D	6.25	0.2461	34.0	79.0	36.0	8.00
R4586.3	–	6.30	0.2480	34.0	79.0	36.0	8.00
R4581/4	1/4	6.35	0.2500	34.0	79.0	36.0	8.00
R458E	E	6.35	0.2500	34.0	79.0	36.0	8.00
R4586.4	–	6.40	0.2520	34.0	79.0	36.0	8.00
R4586.5	–	6.50	0.2559	34.0	79.0	36.0	8.00
R458F	F	6.53	0.2571	34.0	79.0	36.0	8.00
R4586.6	–	6.60	0.2598	34.0	79.0	36.0	8.00
R458G	G	6.63	0.2610	34.0	79.0	36.0	8.00
R4586.7	–	6.70	0.2638	34.0	79.0	36.0	8.00
R45817/64	17/64	6.75	0.2656	34.0	79.0	36.0	8.00
R458H	H	6.76	0.2661	34.0	79.0	36.0	8.00
R4586.8	–	6.80	0.2677	34.0	79.0	36.0	8.00
R4586.9	–	6.90	0.2717	34.0	79.0	36.0	8.00
R458I	I	6.91	0.2720	34.0	79.0	36.0	8.00



Produkt	DC	DC	DC	LCF	OAL	LS	DCON MS
	(inch)	(mm)	(inch)	(mm)	(mm)	(mm)	(mm)
R4587.0	–	7.00	0.2756	34.0	79.0	36.0	8.00
R458J	J	7.04	0.2772	34.0	79.0	36.0	8.00
R4587.1	–	7.10	0.2795	41.0	79.0	36.0	8.00
R458K	K	7.14	0.2811	41.0	79.0	36.0	8.00
R4589/32	9/32	7.14	0.2813	41.0	79.0	36.0	8.00
R4587.2	–	7.20	0.2835	41.0	79.0	36.0	8.00
R4587.3	–	7.30	0.2874	41.0	79.0	36.0	8.00
R458L	L	7.37	0.2902	41.0	79.0	36.0	8.00
R4587.4	–	7.40	0.2913	41.0	79.0	36.0	8.00
R458M	M	7.49	0.2949	41.0	79.0	36.0	8.00
R4587.5	–	7.50	0.2953	41.0	79.0	36.0	8.00
R45819/64	19/64	7.54	0.2969	41.0	79.0	36.0	8.00
R4587.6	–	7.60	0.2992	41.0	79.0	36.0	8.00
R458N	N	7.67	0.3020	41.0	79.0	36.0	8.00
R4587.7	–	7.70	0.3031	41.0	79.0	36.0	8.00
R4587.8	–	7.80	0.3071	41.0	79.0	36.0	8.00
R4587.9	–	7.90	0.3110	41.0	79.0	36.0	8.00
R4585/16	5/16	7.94	0.3125	41.0	79.0	36.0	8.00
R4588.0	–	8.00	0.3150	41.0	79.0	36.0	8.00
R458O	O	8.03	0.3161	47.0	89.0	40.0	10.00
R4588.1	–	8.10	0.3189	47.0	89.0	40.0	10.00
R4588.2	–	8.20	0.3228	47.0	89.0	40.0	10.00
R458P	P	8.20	0.3228	47.0	89.0	40.0	10.00
R4588.3	–	8.30	0.3268	47.0	89.0	40.0	10.00
R45821/64	21/64	8.33	0.3281	47.0	89.0	40.0	10.00
R4588.4	–	8.40	0.3307	47.0	89.0	40.0	10.00
R458Q	Q	8.43	0.3319	47.0	89.0	40.0	10.00
R4588.5	–	8.50	0.3346	47.0	89.0	40.0	10.00
R4588.6	–	8.60	0.3386	47.0	89.0	40.0	10.00
R458R	R	8.61	0.3390	47.0	89.0	40.0	10.00
R4588.7	–	8.70	0.3425	47.0	89.0	40.0	10.00
R45811/32	11/32	8.73	0.3438	47.0	89.0	40.0	10.00
R4588.8	–	8.80	0.3465	47.0	89.0	40.0	10.00
R458S	S	8.84	0.3480	47.0	89.0	40.0	10.00
R4588.9	–	8.90	0.3504	47.0	89.0	40.0	10.00
R4589.0	–	9.00	0.3543	47.0	89.0	40.0	10.00
R458T	T	9.09	0.3579	47.0	89.0	40.0	10.00
R4589.1	–	9.10	0.3583	47.0	89.0	40.0	10.00
R45823/64	23/64	9.13	0.3594	47.0	89.0	40.0	10.00
R4589.2	–	9.20	0.3622	47.0	89.0	40.0	10.00
R4589.3	–	9.30	0.3661	47.0	89.0	40.0	10.00
R458U	U	9.35	0.3681	47.0	89.0	40.0	10.00
R4589.4	–	9.40	0.3701	47.0	89.0	40.0	10.00
R4589.5	–	9.50	0.3740	47.0	89.0	40.0	10.00
R4583/8	3/8	9.53	0.3750	47.0	89.0	40.0	10.00
R458V	V	9.58	0.3772	47.0	89.0	40.0	10.00
R4589.6	–	9.60	0.3780	47.0	89.0	40.0	10.00
R4589.7	–	9.70	0.3819	47.0	89.0	40.0	10.00
R4589.8	–	9.80	0.3858	47.0	89.0	40.0	10.00
R458W	W	9.80	0.3858	47.0	89.0	40.0	10.00
R4589.9	–	9.90	0.3898	47.0	89.0	40.0	10.00
R45825/64	25/64	9.92	0.3906	47.0	89.0	40.0	10.00
R45810.0	–	10.00	0.3937	47.0	89.0	40.0	10.00
R458X	X	10.08	0.3969	55.0	102.0	45.0	12.00
R45810.1	–	10.10	0.3976	55.0	102.0	45.0	12.00
R45810.2	–	10.20	0.4016	55.0	102.0	45.0	12.00
R458Y	Y	10.26	0.4039	55.0	102.0	45.0	12.00
R45810.3	–	10.30	0.4055	55.0	102.0	45.0	12.00
R45813/32	13/32	10.32	0.4063	55.0	102.0	45.0	12.00
R45810.4	–	10.40	0.4094	55.0	102.0	45.0	12.00
R458Z	Z	10.49	0.4130	55.0	102.0	45.0	12.00
R45810.5	–	10.50	0.4134	55.0	102.0	45.0	12.00
R45810.6	–	10.60	0.4173	55.0	102.0	45.0	12.00
R45810.7	–	10.70	0.4213	55.0	102.0	45.0	12.00
R45827/64	27/64	10.72	0.4219	55.0	102.0	45.0	12.00



Produkt	DC	DC	DC	LCF	OAL	LS	DCON MS
	(inch)	(mm)	(inch)	(mm)	(mm)	(mm)	(mm)
R45810.8	–	10.80	0.4252	55.0	102.0	45.0	12.00
R45810.9	–	10.90	0.4291	55.0	102.0	45.0	12.00
R45811.0	–	11.00	0.4331	55.0	102.0	45.0	12.00
R45811.1	–	11.10	0.4370	55.0	102.0	45.0	12.00
R4587/16	7/16	11.11	0.4375	55.0	102.0	45.0	12.00
R45811.2	–	11.20	0.4409	55.0	102.0	45.0	12.00
R45811.3	–	11.30	0.4449	55.0	102.0	45.0	12.00
R45811.4	–	11.40	0.4488	55.0	102.0	45.0	12.00
R45811.5	–	11.50	0.4528	55.0	102.0	45.0	12.00
R45829/64	29/64	11.51	0.4531	55.0	102.0	45.0	12.00
R45811.6	–	11.60	0.4567	55.0	102.0	45.0	12.00
R45811.7	–	11.70	0.4606	55.0	102.0	45.0	12.00
R45811.8	–	11.80	0.4646	55.0	102.0	45.0	12.00
R45811.9	–	11.90	0.4685	55.0	102.0	45.0	12.00
R45815/32	15/32	11.91	0.4688	55.0	102.0	45.0	12.00
R45812.0	–	12.00	0.4724	55.0	102.0	45.0	12.00
R45812.1	–	12.10	0.4764	60.0	107.0	45.0	14.00
R45812.2	–	12.20	0.4803	60.0	107.0	45.0	14.00
R45831/64	31/64	12.30	0.4844	60.0	107.0	45.0	14.00
R45812.5	–	12.50	0.4921	60.0	107.0	45.0	14.00
R45812.7	–	12.70	0.5000	60.0	107.0	45.0	14.00
R4581/2	1/2	12.70	0.5000	60.0	107.0	45.0	14.00
R45812.8	–	12.80	0.5039	60.0	107.0	45.0	14.00
R45813.0	–	13.00	0.5118	60.0	107.0	45.0	14.00
R45833/64	33/64	13.10	0.5156	60.0	107.0	45.0	14.00
R45813.3	–	13.30	0.5236	60.0	107.0	45.0	14.00
R45817/32	17/32	13.49	0.5313	60.0	107.0	45.0	14.00
R45813.5	–	13.50	0.5315	60.0	107.0	45.0	14.00
R45813.8	–	13.80	0.5433	60.0	107.0	45.0	14.00
R45835/64	35/64	13.89	0.5469	60.0	107.0	45.0	14.00
R45814.0	–	14.00	0.5512	60.0	107.0	45.0	14.00
R45814.25	–	14.25	0.5610	65.0	115.0	48.0	16.00
R4589/16	9/16	14.29	0.5625	65.0	115.0	48.0	16.00
R45814.5	–	14.50	0.5709	65.0	115.0	48.0	16.00
R45837/64	37/64	14.68	0.5781	65.0	115.0	48.0	16.00
R45814.8	–	14.80	0.5827	65.0	115.0	48.0	16.00
R45815.0	–	15.00	0.5906	65.0	115.0	48.0	16.00
R45819/32	19/32	15.08	0.5938	65.0	115.0	48.0	16.00
R45815.1	–	15.10	0.5945	65.0	115.0	48.0	16.00
R45815.3	–	15.30	0.6024	65.0	115.0	48.0	16.00
R45839/64	39/64	15.48	0.6094	65.0	115.0	48.0	16.00
R45815.5	–	15.50	0.6102	65.0	115.0	48.0	16.00
R45815.8	–	15.80	0.6220	65.0	115.0	48.0	16.00
R4585/8	5/8	15.88	0.6250	65.0	115.0	48.0	16.00
R45816.0	–	16.00	0.6299	65.0	115.0	48.0	16.00
R45841/64	41/64	16.27	0.6406	73.0	123.0	48.0	18.00
R45816.5	–	16.50	0.6496	73.0	123.0	48.0	18.00
R45821/32	21/32	16.67	0.6563	73.0	123.0	48.0	18.00
R45817.0	–	17.00	0.6693	73.0	123.0	48.0	18.00
R45843/64	43/64	17.07	0.6720	73.0	123.0	48.0	18.00
R45811/16	11/16	17.46	0.6874	73.0	123.0	48.0	18.00
R45817.5	–	17.50	0.6890	73.0	123.0	48.0	18.00
R45817.8	–	17.80	0.7008	73.0	123.0	48.0	18.00
R45845/64	45/64	17.86	0.7031	73.0	123.0	48.0	18.00
R45818.0	–	18.00	0.7087	73.0	123.0	48.0	18.00
R45823/32	23/32	18.26	0.7189	79.0	131.0	50.0	20.00
R45818.5	–	18.50	0.7283	79.0	131.0	50.0	20.00
R45847/64	47/64	18.65	0.7343	79.0	131.0	50.0	20.00
R45819.0	–	19.00	0.7480	79.0	131.0	50.0	20.00
R4583/4	–	19.05	0.7500	79.0	131.0	50.0	20.00
R45819.5	–	19.50	0.7677	79.0	131.0	50.0	20.00
R45819.8	–	19.80	0.7795	79.0	131.0	50.0	20.00
R45820.0	–	20.00	0.7874	79.0	131.0	50.0	20.00



R457



FORCE X Monolitní karbidový vrták 3xD s vnitřním chlazením, Povlakovaný TiAlN

Produktivní vrták pro kvalitní a přesné otvory, vhodný pro vysoké řezné rychlosti a velké posuvy (tolerance otvorů H9). Vrcholový úhel 140°, konstrukce se 4 fazetkami a spec. drážkou pro snazší proniknutí do materiálu. Vnitřní chlazení zlepšuje odvod třísek. Povlak TiAlN zvyšuje tvrdost povrchu nástroje a prodlužuje životnost.

FORCE X

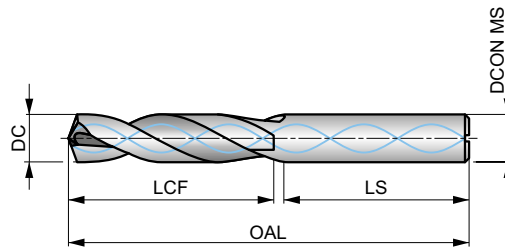

HM	DIN 6537K	3xD
140°	TiAlN	DIN 6535HA
GTW	DC m7	

Skupiny obráběných materiálů, startovní řezná rychlost (Vc m/min) a kód posuvu. Tabulku s posuvem na otáčku naleznete od strany 65.

P1.1 ■ 179 W	P1.2 ■ 200 W	P1.3 ■ 207 W	P2.1 ■ 153 W	P2.2 ■ 135 W	P2.3 ■ 119 V	P3.1 ■ 133 V	P3.2 ■ 107 V	P3.3 ■ 90 V	P4.1 ■ 79 V	P4.2 ■ 67 V	P4.3 ■ 55 U	M1.1 ■ 75 V	M1.2 ■ 64 V
M2.1 ■ 67 V	M2.2 ■ 55 V	M2.3 ■ 46 U	M3.1 ■ 41 V	M3.2 ■ 35 V	M3.3 ■ 32 V	M4.1 ■ 30 U	M4.2 ■ 26 U	K1.1 ■ 110 W	K1.2 ■ 81 W	K1.3 ■ 61 W	K2.1 ■ 98 V	K2.2 ■ 80 V	K2.3 ■ 64 V
K3.1 ■ 87 V	K3.2 ■ 67 V	K3.3 ■ 54 V	K4.1 ■ 81 V	K4.2 ■ 61 V	K4.3 ■ 45 V	K4.4 ■ 38 V	K4.5 ■ 32 V	K5.1 ■ 91 V	K5.2 ■ 69 V	K5.3 ■ 53 V	N1.1 ■ 250 W	N1.2 ■ 188 W	N1.3 ■ 125 W
N2.1 ■ 308 V	N2.2 ■ 277 V	N2.3 ■ 200 V	N3.1 ■ 373 W	N3.2 ■ 220 W	N3.3 ■ 110 W	S1.1 ■ 55 V	S1.2 ■ 45 V	S1.3 ■ 40 U	H1.1 ■ 56 U	H2.1 ■ 33 U	H2.2 ■ 30 U	H3.1 ■ 37 U	H3.2 ■ 30 U

DCON MS v toleranci h6.

Produkt	DC (inch)	DC (mm)	DC (inch)	LCF (mm)	OAL (mm)	LS (mm)	DCON MS (mm)
R4573.0	–	3.00	0.1181	20.0	62.0	36.0	6.00
R4573.1	–	3.10	0.1220	20.0	62.0	36.0	6.00
R4571/8	1/8	3.18	0.1250	20.0	62.0	36.0	6.00
R4573.2	–	3.20	0.1260	20.0	62.0	36.0	6.00
R457N30	N30	3.26	0.1283	20.0	62.0	36.0	6.00
R4573.3	–	3.30	0.1299	20.0	62.0	36.0	6.00
R4573.4	–	3.40	0.1339	20.0	62.0	36.0	6.00
R457N29	N29	3.45	0.1360	20.0	62.0	36.0	6.00
R4573.5	–	3.50	0.1378	20.0	62.0	36.0	6.00
R457N28	N28	3.57	0.1406	20.0	62.0	36.0	6.00
R4579/64	9/64	3.57	0.1406	20.0	62.0	36.0	6.00
R4573.6	–	3.60	0.1417	20.0	62.0	36.0	6.00
R457N27	N27	3.66	0.1441	20.0	62.0	36.0	6.00
R4573.7	–	3.70	0.1457	20.0	62.0	36.0	6.00
R457N26	N26	3.73	0.1469	24.0	66.0	36.0	6.00
R457N25	N25	3.80	0.1496	24.0	66.0	36.0	6.00
R4573.8	–	3.80	0.1496	24.0	66.0	36.0	6.00
R457N24	N24	3.86	0.1520	24.0	66.0	36.0	6.00
R4573.9	–	3.90	0.1535	24.0	66.0	36.0	6.00
R457N23	N23	3.91	0.1539	24.0	66.0	36.0	6.00
R4575/32	5/32	3.97	0.1563	24.0	66.0	36.0	6.00
R457N22	N22	3.99	0.1571	24.0	66.0	36.0	6.00
R4574.0	–	4.00	0.1575	24.0	66.0	36.0	6.00
R457N21	N21	4.04	0.1591	24.0	66.0	36.0	6.00
R4574.05	–	4.05	0.1594	24.0	66.0	36.0	6.00



Produkt	DC	DC	DC	LCF	OAL	LS	DCON MS
	(inch)	(mm)	(inch)	(mm)	(mm)	(mm)	(mm)
R457N20	N20	4.09	0.1610	24.0	66.0	36.0	6.00
R4574.1	–	4.10	0.1614	24.0	66.0	36.0	6.00
R4574.2	–	4.20	0.1654	24.0	66.0	36.0	6.00
R457N19	N19	4.22	0.1661	24.0	66.0	36.0	6.00
R4574.3	–	4.30	0.1693	24.0	66.0	36.0	6.00
R457N18	N18	4.31	0.1697	24.0	66.0	36.0	6.00
R45711/64	11/64	4.37	0.1719	24.0	66.0	36.0	6.00
R457N17	N17	4.39	0.1728	24.0	66.0	36.0	6.00
R4574.4	–	4.40	0.1732	24.0	66.0	36.0	6.00
R4574.5	–	4.50	0.1772	24.0	66.0	36.0	6.00
R457N16	N16	4.50	0.1772	24.0	66.0	36.0	6.00
R457N15	N15	4.57	0.1799	24.0	66.0	36.0	6.00
R4574.6	–	4.60	0.1811	24.0	66.0	36.0	6.00
R457N14	N14	4.62	0.1819	24.0	66.0	36.0	6.00
R457N13	N13	4.70	0.1850	24.0	66.0	36.0	6.00
R4574.7	–	4.70	0.1850	24.0	66.0	36.0	6.00
R4573/16	3/16	4.76	0.1875	28.0	66.0	36.0	6.00
R4574.8	–	4.80	0.1890	28.0	66.0	36.0	6.00
R457N12	N12	4.80	0.1890	28.0	66.0	36.0	6.00
R457N11	N11	4.85	0.1909	28.0	66.0	36.0	6.00
R4574.9	–	4.90	0.1929	28.0	66.0	36.0	6.00
R457N10	N10	4.92	0.1937	28.0	66.0	36.0	6.00
R457N9	N9	4.98	0.1961	28.0	66.0	36.0	6.00
R4575.0	–	5.00	0.1969	28.0	66.0	36.0	6.00
R4575.05	–	5.05	0.1988	28.0	66.0	36.0	6.00
R457N8	N8	5.06	0.1992	28.0	66.0	36.0	6.00
R4575.1	–	5.10	0.2008	28.0	66.0	36.0	6.00
R457N7	N7	5.11	0.2010	28.0	66.0	36.0	6.00
R45713/64	13/64	5.16	0.2031	28.0	66.0	36.0	6.00
R457N6	N6	5.18	0.2039	28.0	66.0	36.0	6.00
R4575.2	–	5.20	0.2047	28.0	66.0	36.0	6.00
R457N5	N5	5.22	0.2055	28.0	66.0	36.0	6.00
R4575.3	–	5.30	0.2087	28.0	66.0	36.0	6.00
R457N4	N4	5.31	0.2091	28.0	66.0	36.0	6.00
R4575.4	–	5.40	0.2126	28.0	66.0	36.0	6.00
R457N3	N3	5.41	0.2130	28.0	66.0	36.0	6.00
R4575.5	–	5.50	0.2165	28.0	66.0	36.0	6.00
R4577/32	7/32	5.56	0.2188	28.0	66.0	36.0	6.00
R4575.6	–	5.60	0.2205	28.0	66.0	36.0	6.00
R457N2	N2	5.61	0.2209	28.0	66.0	36.0	6.00
R4575.7	–	5.70	0.2244	28.0	66.0	36.0	6.00
R457N1	N1	5.79	0.2280	28.0	66.0	36.0	6.00
R4575.8	–	5.80	0.2283	28.0	66.0	36.0	6.00
R4575.9	–	5.90	0.2323	28.0	66.0	36.0	6.00
R457A	A	5.94	0.2339	28.0	66.0	36.0	6.00
R45715/64	15/64	5.95	0.2344	28.0	66.0	36.0	6.00
R4576.0	–	6.00	0.2362	28.0	66.0	36.0	6.00
R457B	B	6.05	0.2380	34.0	79.0	36.0	8.00
R4576.05	–	6.05	0.2382	34.0	79.0	36.0	8.00
R4576.1	–	6.10	0.2402	34.0	79.0	36.0	8.00
R457C	C	6.15	0.2421	34.0	79.0	36.0	8.00
R4576.2	–	6.20	0.2441	34.0	79.0	36.0	8.00
R457D	D	6.25	0.2461	34.0	79.0	36.0	8.00
R4576.3	–	6.30	0.2480	34.0	79.0	36.0	8.00
R4571/4	1/4	6.35	0.2500	34.0	79.0	36.0	8.00
R457E	E	6.35	0.2500	34.0	79.0	36.0	8.00
R4576.4	–	6.40	0.2520	34.0	79.0	36.0	8.00
R4576.5	–	6.50	0.2559	34.0	79.0	36.0	8.00
R457F	F	6.53	0.2571	34.0	79.0	36.0	8.00
R4576.6	–	6.60	0.2598	34.0	79.0	36.0	8.00
R457G	G	6.63	0.2610	34.0	79.0	36.0	8.00
R4576.7	–	6.70	0.2638	34.0	79.0	36.0	8.00
R45717/64	17/64	6.75	0.2656	34.0	79.0	36.0	8.00
R457H	H	6.76	0.2661	34.0	79.0	36.0	8.00
R4576.8	–	6.80	0.2677	34.0	79.0	36.0	8.00



Produkt	DC	DC	DC	LCF	OAL	LS	DCON MS
	(inch)	(mm)	(inch)	(mm)	(mm)	(mm)	(mm)
R4576.9	–	6.90	0.2717	34.0	79.0	36.0	8.00
R457I	I	6.91	0.2720	34.0	79.0	36.0	8.00
R4577.0	–	7.00	0.2756	34.0	79.0	36.0	8.00
R457J	J	7.04	0.2772	41.0	79.0	36.0	8.00
R4577.1	–	7.10	0.2795	41.0	79.0	36.0	8.00
R457K	K	7.14	0.2811	41.0	79.0	36.0	8.00
R4579/32	9/32	7.14	0.2813	41.0	79.0	36.0	8.00
R4577.2	–	7.20	0.2835	41.0	79.0	36.0	8.00
R4577.3	–	7.30	0.2874	41.0	79.0	36.0	8.00
R457L	L	7.37	0.2902	41.0	79.0	36.0	8.00
R4577.4	–	7.40	0.2913	41.0	79.0	36.0	8.00
R457M	M	7.49	0.2949	41.0	79.0	36.0	8.00
R4577.5	–	7.50	0.2953	41.0	79.0	36.0	8.00
R45719/64	19/64	7.54	0.2969	41.0	79.0	36.0	8.00
R4577.6	–	7.60	0.2992	41.0	79.0	36.0	8.00
R457N	N	7.67	0.3020	41.0	79.0	36.0	8.00
R4577.7	–	7.70	0.3031	41.0	79.0	36.0	8.00
R4577.8	–	7.80	0.3071	41.0	79.0	36.0	8.00
R4577.9	–	7.90	0.3110	41.0	79.0	36.0	8.00
R4575/16	5/16	7.94	0.3125	41.0	79.0	36.0	8.00
R4578.0	–	8.00	0.3150	41.0	79.0	36.0	8.00
R457O	O	8.03	0.3161	47.0	89.0	40.0	10.00
R4578.05	–	8.05	0.3169	47.0	89.0	40.0	10.00
R4578.1	–	8.10	0.3189	47.0	89.0	40.0	10.00
R4578.2	–	8.20	0.3228	47.0	89.0	40.0	10.00
R457P	P	8.20	0.3228	47.0	89.0	40.0	10.00
R4578.3	–	8.30	0.3268	47.0	89.0	40.0	10.00
R45721/64	21/64	8.33	0.3281	47.0	89.0	40.0	10.00
R4578.4	–	8.40	0.3307	47.0	89.0	40.0	10.00
R457Q	Q	8.43	0.3319	47.0	89.0	40.0	10.00
R4578.5	–	8.50	0.3346	47.0	89.0	40.0	10.00
R4578.6	–	8.60	0.3386	47.0	89.0	40.0	10.00
R457R	R	8.61	0.3390	47.0	89.0	40.0	10.00
R4578.7	–	8.70	0.3425	47.0	89.0	40.0	10.00
R45711/32	11/32	8.73	0.3438	47.0	89.0	40.0	10.00
R4578.8	–	8.80	0.3465	47.0	89.0	40.0	10.00
R457S	S	8.84	0.3480	47.0	89.0	40.0	10.00
R4578.9	–	8.90	0.3504	47.0	89.0	40.0	10.00
R4579.0	–	9.00	0.3543	47.0	89.0	40.0	10.00
R457T	T	9.09	0.3579	47.0	89.0	40.0	10.00
R4579.1	–	9.10	0.3583	47.0	89.0	40.0	10.00
R45723/64	23/64	9.13	0.3594	47.0	89.0	40.0	10.00
R4579.2	–	9.20	0.3622	47.0	89.0	40.0	10.00
R4579.3	–	9.30	0.3661	47.0	89.0	40.0	10.00
R457U	U	9.35	0.3681	47.0	89.0	40.0	10.00
R4579.4	–	9.40	0.3701	47.0	89.0	40.0	10.00
R4579.5	–	9.50	0.3740	47.0	89.0	40.0	10.00
R4573/8	3/8	9.53	0.3750	47.0	89.0	40.0	10.00
R457V	V	9.58	0.3772	47.0	89.0	40.0	10.00
R4579.6	–	9.60	0.3780	47.0	89.0	40.0	10.00
R4579.7	–	9.70	0.3819	47.0	89.0	40.0	10.00
R4579.8	–	9.80	0.3858	47.0	89.0	40.0	10.00
R457W	W	9.80	0.3858	47.0	89.0	40.0	10.00
R4579.9	–	9.90	0.3898	47.0	89.0	40.0	10.00
R45725/64	25/64	9.92	0.3906	47.0	89.0	40.0	10.00
R45710.0	–	10.00	0.3937	47.0	89.0	40.0	10.00
R45710.05	–	10.05	0.3957	55.0	102.0	45.0	12.00
R457X	X	10.08	0.3969	55.0	102.0	45.0	12.00
R45710.1	–	10.10	0.3976	55.0	102.0	45.0	12.00
R45710.2	–	10.20	0.4016	55.0	102.0	45.0	12.00
R457Y	Y	10.26	0.4039	55.0	102.0	45.0	12.00
R45710.3	–	10.30	0.4055	55.0	102.0	45.0	12.00
R45713/32	13/32	10.32	0.4063	55.0	102.0	45.0	12.00
R45710.4	–	10.40	0.4094	55.0	102.0	45.0	12.00
R457Z	Z	10.49	0.4130	55.0	102.0	45.0	12.00



Produkt	DC	DC	DC	LCF	OAL	LS	DCON MS
	(inch)	(mm)	(inch)	(mm)	(mm)	(mm)	(mm)
R45710.5	–	10.50	0.4134	55.0	102.0	45.0	12.00
R45710.6	–	10.60	0.4173	55.0	102.0	45.0	12.00
R45727/64	27/64	10.72	0.4219	55.0	102.0	45.0	12.00
R45710.8	–	10.80	0.4252	55.0	102.0	45.0	12.00
R45711.0	–	11.00	0.4331	55.0	102.0	45.0	12.00
R4577/16	7/16	11.11	0.4375	55.0	102.0	45.0	12.00
R45711.2	–	11.20	0.4409	55.0	102.0	45.0	12.00
R45711.3	–	11.30	0.4449	55.0	102.0	45.0	12.00
R45711.4	–	11.40	0.4488	55.0	102.0	45.0	12.00
R45711.5	–	11.50	0.4528	55.0	102.0	45.0	12.00
R45729/64	29/64	11.51	0.4531	55.0	102.0	45.0	12.00
R45711.6	–	11.60	0.4567	55.0	102.0	45.0	12.00
R45711.8	–	11.80	0.4646	55.0	102.0	45.0	12.00
R45715/32	15/32	11.91	0.4688	55.0	102.0	45.0	12.00
R45712.0	–	12.00	0.4724	55.0	102.0	45.0	12.00
R45712.05	–	12.05	0.4744	60.0	107.0	45.0	14.00
R45712.1	–	12.10	0.4764	60.0	107.0	45.0	14.00
R45712.2	–	12.20	0.4803	60.0	107.0	45.0	14.00
R45731/64	31/64	12.30	0.4844	60.0	107.0	45.0	14.00
R45712.5	–	12.50	0.4921	60.0	107.0	45.0	14.00
R45712.7	–	12.70	0.5000	60.0	107.0	45.0	14.00
R4571/2	1/2	12.70	0.5000	60.0	107.0	45.0	14.00
R45712.8	–	12.80	0.5039	60.0	107.0	45.0	14.00
R45713.0	–	13.00	0.5118	60.0	107.0	45.0	14.00
R45733/64	33/64	13.10	0.5156	60.0	107.0	45.0	14.00
R45713.3	–	13.30	0.5236	60.0	107.0	45.0	14.00
R45717/32	17/32	13.49	0.5313	60.0	107.0	45.0	14.00
R45713.5	–	13.50	0.5315	60.0	107.0	45.0	14.00
R45713.8	–	13.80	0.5433	60.0	107.0	45.0	14.00
R45735/64	35/64	13.89	0.5469	60.0	107.0	45.0	14.00
R45714.0	–	14.00	0.5512	60.0	107.0	45.0	14.00
R45714.25	–	14.25	0.5610	65.0	115.0	48.0	16.00
R4579/16	9/16	14.29	0.5625	65.0	115.0	48.0	16.00
R45714.5	–	14.50	0.5709	65.0	115.0	48.0	16.00
R45737/64	37/64	14.68	0.5781	65.0	115.0	48.0	16.00
R45714.8	–	14.80	0.5827	65.0	115.0	48.0	16.00
R45715.0	–	15.00	0.5906	65.0	115.0	48.0	16.00
R45719/32	19/32	15.08	0.5938	65.0	115.0	48.0	16.00
R45715.1	–	15.10	0.5945	65.0	115.0	48.0	16.00
R45715.3	–	15.30	0.6024	65.0	115.0	48.0	16.00
R45739/64	39/64	15.48	0.6094	65.0	115.0	48.0	16.00
R45715.5	–	15.50	0.6102	65.0	115.0	48.0	16.00
R45715.8	–	15.80	0.6220	65.0	115.0	48.0	16.00
R4575/8	5/8	15.88	0.6250	65.0	115.0	48.0	16.00
R45716.0	–	16.00	0.6299	65.0	115.0	48.0	16.00
R45741/64	41/64	16.27	0.6406	73.0	123.0	48.0	18.00
R45716.5	–	16.50	0.6496	73.0	123.0	48.0	18.00
R45721/32	21/32	16.67	0.6563	73.0	123.0	48.0	18.00
R45717.0	–	17.00	0.6693	73.0	123.0	48.0	18.00
R45743/64	43/64	17.07	0.6720	73.0	123.0	48.0	18.00
R45711/16	11/16	17.46	0.6874	73.0	123.0	48.0	18.00
R45717.5	–	17.50	0.6890	73.0	123.0	48.0	18.00
R45745/64	45/64	17.86	0.7031	73.0	123.0	48.0	18.00
R45718.0	–	18.00	0.7087	73.0	123.0	48.0	18.00
R45723/32	23/32	18.26	0.7189	79.0	131.0	50.0	20.00
R45718.5	–	18.50	0.7283	79.0	131.0	50.0	20.00
R45747/64	47/64	18.65	0.7343	79.0	131.0	50.0	20.00
R45718.8	–	18.80	0.7402	79.0	131.0	50.0	20.00
R45719.0	–	19.00	0.7480	79.0	131.0	50.0	20.00
R4573/4	3/4	19.05	0.7500	79.0	131.0	50.0	20.00
R45719.5	–	19.50	0.7677	79.0	131.0	50.0	20.00
R45719.8	–	19.80	0.7795	79.0	131.0	50.0	20.00
R45720.0	–	20.00	0.7874	79.0	131.0	50.0	20.00



R454



FORCE X Monolitní karbidový vrták 5xD, Povlakovaný TiAlN

Produktivní vrták pro kvalitní a přesné otvory, vhodný pro vysoké řezné rychlosti a velké posuvy (tolerance otvorů H9). Vrcholový úhel 140°, konstrukce se 4 fazetkami a spec. drážkou CTW pro snazší proniknutí do materiálu. Povlak TiAlN zvyšuje tvrdost povrchu nástroje a prodlužuje životnost.

FORCE X

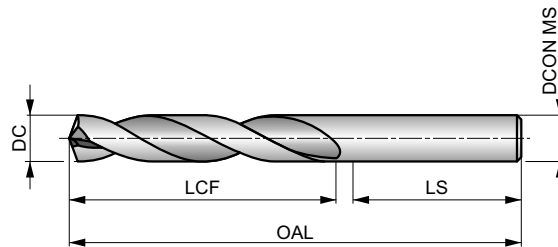

HM	DIN 6537L	5xD
140°	TiAlN	DIN 6535HA
CTW	DC m7	

Skupiny obráběných materiálů, startovní řezná rychlost (Vc m/min) a kód posuvu. Tabulku s posuvem na otáčku naleznete od strany 65.

P1.1 ■ 134 V	P1.2 ■ 150 V	P1.3 ■ 155 V	P2.1 ■ 115 V	P2.2 ■ 101 V	P2.3 ■ 89 V	P3.1 ■ 100 V	P3.2 ■ 80 V	P3.3 ■ 68 V	P4.1 ■ 59 V	P4.2 ■ 50 V	P4.3 ■ 41 U	M1.1 ■ 56 U	M1.2 ■ 48 U
M2.1 ■ 50 U	M2.2 ■ 41 U	M2.3 ■ 35 T	M3.1 ■ 31 T	M3.2 ■ 26 T	M3.3 ■ 24 T	M4.1 ■ 23 T	M4.2 ■ 20 T	K1.1 ■ 83 W	K1.2 ■ 61 W	K1.3 ■ 46 W	K2.1 ■ 74 V	K2.2 ■ 60 V	K2.3 ■ 48 V
K3.1 ■ 65 V	K3.2 ■ 50 V	K3.3 ■ 41 V	K4.1 ■ 61 V	K4.2 ■ 46 V	K4.3 ■ 34 V	K4.4 ■ 29 V	K4.5 ■ 24 V	K5.1 ■ 68 V	K5.2 ■ 52 V	K5.3 ■ 40 V	N1.1 ■ 188 W	N1.2 ■ 141 W	N1.3 ■ 94 W
N2.1 ■ 231 V	N2.2 ■ 208 V	N2.3 ■ 150 V	N3.1 ■ 280 V	N3.2 ■ 165 V	N3.3 ■ 83 V	S1.1 ■ 41 U	S1.2 ■ 34 U	S1.3 ■ 30 T	H1.1 ■ 42 U	H2.1 ■ 25 U	H2.2 ■ 23 U	H3.1 ■ 28 U	H3.2 ■ 23 U

DCON MS v toleranci h6.

Produkt	DC	DC	DC	LCF	OAL	LS	DCON MS
	(inch)	(mm)	(inch)	(mm)	(mm)	(mm)	(mm)
R4543.0	–	3.00	0.1181	28.0	66.0	36.0	6.00
R4543.1	–	3.10	0.1220	28.0	66.0	36.0	6.00
R4541/8	1/8	3.18	0.1250	28.0	66.0	36.0	6.00
R4543.2	–	3.20	0.1260	28.0	66.0	36.0	6.00
R454N30	N30	3.26	0.1283	28.0	66.0	36.0	6.00
R4543.3	–	3.30	0.1299	28.0	66.0	36.0	6.00
R4543.4	–	3.40	0.1339	28.0	66.0	36.0	6.00
R454N29	N29	3.45	0.1360	28.0	66.0	36.0	6.00
R4543.5	–	3.50	0.1378	28.0	66.0	36.0	6.00
R454N28	N28	3.57	0.1406	28.0	66.0	36.0	6.00
R4549/64	9/64	3.57	0.1406	28.0	66.0	36.0	6.00
R4543.6	–	3.60	0.1417	28.0	66.0	36.0	6.00
R454N27	N27	3.66	0.1441	28.0	66.0	36.0	6.00
R4543.7	–	3.70	0.1457	28.0	66.0	36.0	6.00
R454N26	N26	3.73	0.1469	36.0	74.0	36.0	6.00
R454N25	N25	3.80	0.1496	36.0	74.0	36.0	6.00
R4543.8	–	3.80	0.1496	36.0	74.0	36.0	6.00
R454N24	N24	3.86	0.1520	36.0	74.0	36.0	6.00
R4543.9	–	3.90	0.1535	36.0	74.0	36.0	6.00
R454N23	N23	3.91	0.1539	36.0	74.0	36.0	6.00
R4545/32	5/32	3.97	0.1563	36.0	74.0	36.0	6.00
R454N22	N22	3.99	0.1571	36.0	74.0	36.0	6.00
R4544.0	–	4.00	0.1575	36.0	74.0	36.0	6.00
R454N21	N21	4.04	0.1591	36.0	74.0	36.0	6.00
R454N20	N20	4.09	0.1610	36.0	74.0	36.0	6.00



Produkt	DC	DC	DC	LCF	OAL	LS	DCON MS
	(inch)	(mm)	(inch)	(mm)	(mm)	(mm)	(mm)
R4544.1	–	4.10	0.1614	36.0	74.0	36.0	6.00
R4544.2	–	4.20	0.1654	36.0	74.0	36.0	6.00
R454N19	N19	4.22	0.1661	36.0	74.0	36.0	6.00
R4544.3	–	4.30	0.1693	36.0	74.0	36.0	6.00
R454N18	N18	4.31	0.1697	36.0	74.0	36.0	6.00
R45411/64	11/64	4.37	0.1719	36.0	74.0	36.0	6.00
R454N17	N17	4.39	0.1728	36.0	74.0	36.0	6.00
R4544.4	–	4.40	0.1732	36.0	74.0	36.0	6.00
R4544.5	–	4.50	0.1772	36.0	74.0	36.0	6.00
R454N16	N16	4.50	0.1772	36.0	74.0	36.0	6.00
R454N15	N15	4.57	0.1799	36.0	74.0	36.0	6.00
R4544.6	–	4.60	0.1811	36.0	74.0	36.0	6.00
R454N14	N14	4.62	0.1819	36.0	74.0	36.0	6.00
R454N13	N13	4.70	0.1850	36.0	74.0	36.0	6.00
R4544.7	–	4.70	0.1850	36.0	74.0	36.0	6.00
R4543/16	3/16	4.76	0.1875	44.0	82.0	36.0	6.00
R454N12	N12	4.80	0.1890	44.0	82.0	36.0	6.00
R4544.8	–	4.80	0.1890	44.0	82.0	36.0	6.00
R454N11	N11	4.85	0.1909	44.0	82.0	36.0	6.00
R4544.9	–	4.90	0.1929	44.0	82.0	36.0	6.00
R454N10	N10	4.92	0.1937	44.0	82.0	36.0	6.00
R454N9	N9	4.98	0.1961	44.0	82.0	36.0	6.00
R4545.0	–	5.00	0.1969	44.0	82.0	36.0	6.00
R454N8	N8	5.06	0.1992	44.0	82.0	36.0	6.00
R4545.1	–	5.10	0.2008	44.0	82.0	36.0	6.00
R454N7	N7	5.11	0.2010	44.0	82.0	36.0	6.00
R45413/64	13/64	5.16	0.2031	44.0	82.0	36.0	6.00
R454N6	N6	5.18	0.2039	44.0	82.0	36.0	6.00
R4545.2	–	5.20	0.2047	44.0	82.0	36.0	6.00
R454N5	N5	5.22	0.2055	44.0	82.0	36.0	6.00
R454N4	N4	5.31	0.2091	44.0	82.0	36.0	6.00
R454N3	N3	5.41	0.2130	44.0	82.0	36.0	6.00
R4545.5	–	5.50	0.2165	44.0	82.0	36.0	6.00
R4547/32	7/32	5.56	0.2188	44.0	82.0	36.0	6.00
R4545.6	–	5.60	0.2205	44.0	82.0	36.0	6.00
R454N2	N2	5.61	0.2209	44.0	82.0	36.0	6.00
R4545.7	–	5.70	0.2244	44.0	82.0	36.0	6.00
R454N1	N1	5.79	0.2280	44.0	82.0	36.0	6.00
R4545.8	–	5.80	0.2283	44.0	82.0	36.0	6.00
R454A	A	5.94	0.2339	44.0	82.0	36.0	6.00
R45415/64	15/64	5.95	0.2344	44.0	82.0	36.0	6.00
R4546.0	–	6.00	0.2362	44.0	82.0	36.0	6.00
R454B	B	6.05	0.2380	53.0	91.0	36.0	8.00
R4546.1	–	6.10	0.2402	53.0	91.0	36.0	8.00
R454C	C	6.15	0.2421	53.0	91.0	36.0	8.00
R4546.2	–	6.20	0.2441	53.0	91.0	36.0	8.00
R454D	D	6.25	0.2461	53.0	91.0	36.0	8.00
R4546.3	–	6.30	0.2480	53.0	91.0	36.0	8.00
R4541/4	1/4	6.35	0.2500	53.0	91.0	36.0	8.00
R454E	E	6.35	0.2500	53.0	91.0	36.0	8.00
R4546.4	–	6.40	0.2520	53.0	91.0	36.0	8.00
R4546.5	–	6.50	0.2559	53.0	91.0	36.0	8.00
R454F	F	6.53	0.2571	53.0	91.0	36.0	8.00
R4546.6	–	6.60	0.2598	53.0	91.0	36.0	8.00
R454G	G	6.63	0.2610	53.0	91.0	36.0	8.00
R4546.7	–	6.70	0.2638	53.0	91.0	36.0	8.00
R45417/64	17/64	6.75	0.2656	53.0	91.0	36.0	8.00
R454H	H	6.76	0.2661	53.0	91.0	36.0	8.00
R4546.8	–	6.80	0.2677	53.0	91.0	36.0	8.00
R4546.9	–	6.90	0.2717	53.0	91.0	36.0	8.00
R454I	I	6.91	0.2720	53.0	91.0	36.0	8.00
R4547.0	–	7.00	0.2756	53.0	91.0	36.0	8.00



Produkt	DC	DC	DC	LCF	OAL	LS	DCON MS
	(inch)	(mm)	(inch)	(mm)	(mm)	(mm)	(mm)
R454J	J	7.04	0.2772	53.0	91.0	36.0	8.00
R4547.1	–	7.10	0.2795	53.0	91.0	36.0	8.00
R454K	K	7.14	0.2811	53.0	91.0	36.0	8.00
R4549/32	9/32	7.14	0.2813	53.0	91.0	36.0	8.00
R4547.3	–	7.30	0.2874	53.0	91.0	36.0	8.00
R454L	L	7.37	0.2902	53.0	91.0	36.0	8.00
R4547.4	–	7.40	0.2913	53.0	91.0	36.0	8.00
R454M	M	7.49	0.2949	53.0	91.0	36.0	8.00
R4547.5	–	7.50	0.2953	53.0	91.0	36.0	8.00
R45419/64	19/64	7.54	0.2969	53.0	91.0	36.0	8.00
R4547.6	–	7.60	0.2992	53.0	91.0	36.0	8.00
R454N	N	7.67	0.3020	53.0	91.0	36.0	8.00
R4547.7	–	7.70	0.3031	53.0	91.0	36.0	8.00
R4547.8	–	7.80	0.3071	53.0	91.0	36.0	8.00
R4547.9	–	7.90	0.3110	53.0	91.0	36.0	8.00
R4545/16	5/16	7.94	0.3125	53.0	91.0	36.0	8.00
R4548.0	–	8.00	0.3150	53.0	91.0	36.0	8.00
R4540	O	8.03	0.3161	61.0	103.0	40.0	10.00
R4548.1	–	8.10	0.3189	61.0	103.0	40.0	10.00
R4548.2	–	8.20	0.3228	61.0	103.0	40.0	10.00
R454P	P	8.20	0.3228	61.0	103.0	40.0	10.00
R45421/64	21/64	8.33	0.3281	61.0	103.0	40.0	10.00
R4548.4	–	8.40	0.3307	61.0	103.0	40.0	10.00
R454Q	Q	8.43	0.3319	61.0	103.0	40.0	10.00
R4548.5	–	8.50	0.3346	61.0	103.0	40.0	10.00
R4548.6	–	8.60	0.3386	61.0	103.0	40.0	10.00
R454R	R	8.61	0.3390	61.0	103.0	40.0	10.00
R4548.7	–	8.70	0.3425	61.0	103.0	40.0	10.00
R45411/32	11/32	8.73	0.3438	61.0	103.0	40.0	10.00
R4548.8	–	8.80	0.3465	61.0	103.0	40.0	10.00
R454S	S	8.84	0.3480	61.0	103.0	40.0	10.00
R4548.9	–	8.90	0.3504	61.0	103.0	40.0	10.00
R4549.0	–	9.00	0.3543	61.0	103.0	40.0	10.00
R454T	T	9.09	0.3579	61.0	103.0	40.0	10.00
R4549.1	–	9.10	0.3583	61.0	103.0	40.0	10.00
R45423/64	23/64	9.13	0.3594	61.0	103.0	40.0	10.00
R4549.3	–	9.30	0.3661	61.0	103.0	40.0	10.00
R454U	U	9.35	0.3681	61.0	103.0	40.0	10.00
R4549.4	–	9.40	0.3701	61.0	103.0	40.0	10.00
R4549.5	–	9.50	0.3740	61.0	103.0	40.0	10.00
R4543/8	3/8	9.53	0.3750	61.0	103.0	40.0	10.00
R454V	V	9.58	0.3772	61.0	103.0	40.0	10.00
R4549.6	–	9.60	0.3780	61.0	103.0	40.0	10.00
R4549.7	–	9.70	0.3819	61.0	103.0	40.0	10.00
R4549.8	–	9.80	0.3858	61.0	103.0	40.0	10.00
R4549.9	–	9.90	0.3898	61.0	103.0	40.0	10.00
R454W	W	9.80	0.3858	61.0	103.0	40.0	10.00
R45425/64	25/64	9.92	0.3906	61.0	103.0	40.0	10.00
R45410.0	–	10.00	0.3937	61.0	103.0	40.0	10.00
R454X	X	10.08	0.3969	70.0	118.0	45.0	12.00
R45410.1	–	10.10	0.3976	70.0	118.0	45.0	12.00
R45410.2	–	10.20	0.4016	70.0	118.0	45.0	12.00
R454Y	Y	10.26	0.4039	70.0	118.0	45.0	12.00
R45410.3	–	10.30	0.4055	70.0	118.0	45.0	12.00
R45413/32	13/32	10.32	0.4063	70.0	118.0	45.0	12.00
R45410.4	–	10.40	0.4094	70.0	118.0	45.0	12.00
R454Z	Z	10.49	0.4130	70.0	118.0	45.0	12.00
R45410.5	–	10.50	0.4134	70.0	118.0	45.0	12.00
R45410.6	–	10.60	0.4173	70.0	118.0	45.0	12.00
R45427/64	27/64	10.72	0.4219	70.0	118.0	45.0	12.00
R45411.0	–	11.00	0.4331	70.0	118.0	45.0	12.00
R4547/16	7/16	11.11	0.4375	70.0	118.0	45.0	12.00



Produkt	DC	DC	DC	LCF	OAL	LS	DCON MS
	(inch)	(mm)	(inch)	(mm)	(mm)	(mm)	(mm)
R45411.2	–	11.20	0.4409	70.0	118.0	45.0	12.00
R45411.4	–	11.40	0.4488	70.0	118.0	45.0	12.00
R45411.5	–	11.50	0.4528	70.0	118.0	45.0	12.00
R45429/64	29/64	11.51	0.4531	70.0	118.0	45.0	12.00
R45411.6	–	11.60	0.4567	70.0	118.0	45.0	12.00
R45411.8	–	11.80	0.4646	70.0	118.0	45.0	12.00
R45415/32	15/32	11.91	0.4688	70.0	118.0	45.0	12.00
R45412.0	–	12.00	0.4724	70.0	118.0	45.0	12.00
R45412.1	–	12.10	0.4764	76.0	124.0	45.0	14.00
R45412.2	–	12.20	0.4803	76.0	124.0	45.0	14.00
R45431/64	31/64	12.30	0.4844	76.0	124.0	45.0	14.00
R45412.5	–	12.50	0.4921	76.0	124.0	45.0	14.00
R45412.7	–	12.70	0.5000	76.0	124.0	45.0	14.00
R4541/2	1/2	12.70	0.5000	76.0	124.0	45.0	14.00
R45412.8	–	12.80	0.5039	76.0	124.0	45.0	14.00
R45413.0	–	13.00	0.5118	76.0	124.0	45.0	14.00
R45433/64	33/64	13.10	0.5156	76.0	124.0	45.0	14.00
R45417/32	17/32	13.49	0.5313	76.0	124.0	45.0	14.00
R45413.5	–	13.50	0.5315	76.0	124.0	45.0	14.00
R45413.8	–	13.80	0.5433	76.0	124.0	45.0	14.00
R45435/64	35/64	13.89	0.5469	76.0	124.0	45.0	14.00
R45414.0	–	14.00	0.5512	76.0	124.0	45.0	14.00
R45414.25	–	14.25	0.5610	82.0	133.0	48.0	16.00
R4549/16	9/16	14.29	0.5625	82.0	133.0	48.0	16.00
R45414.5	–	14.50	0.5709	82.0	133.0	48.0	16.00
R45437/64	37/64	14.68	0.5781	82.0	133.0	48.0	16.00
R45414.8	–	14.80	0.5827	82.0	133.0	48.0	16.00
R45415.0	–	15.00	0.5906	82.0	133.0	48.0	16.00
R45419/32	19/32	15.08	0.5938	82.0	133.0	48.0	16.00
R45415.1	–	15.10	0.5945	82.0	133.0	48.0	16.00
R45439/64	39/64	15.48	0.6094	82.0	133.0	48.0	16.00
R45415.5	–	15.50	0.6102	82.0	133.0	48.0	16.00
R45415.8	–	15.80	0.6220	82.0	133.0	48.0	16.00
R4545/8	5/8	15.88	0.6250	82.0	133.0	48.0	16.00
R45416.0	–	16.00	0.6299	82.0	133.0	48.0	16.00
R45441/64	41/64	16.27	0.6406	91.0	143.0	48.0	18.00
R45416.5	–	16.50	0.6496	91.0	143.0	48.0	18.00
R45421/32	21/32	16.67	0.6563	91.0	143.0	48.0	18.00
R45417.0	–	17.00	0.6693	91.0	143.0	48.0	18.00
R45443/64	43/64	17.07	0.6720	91.0	143.0	48.0	18.00
R45411/16	11/16	17.46	0.6874	91.0	143.0	48.0	18.00
R45417.5	–	17.50	0.6890	91.0	143.0	48.0	18.00
R45417.8	–	17.80	0.7008	91.0	143.0	48.0	18.00
R45445/64	45/64	17.86	0.7031	91.0	143.0	48.0	18.00
R45418.0	–	18.00	0.7087	91.0	143.0	48.0	18.00
R45423/32	23/32	18.26	0.7189	99.0	153.0	50.0	20.00
R45418.5	–	18.50	0.7283	99.0	153.0	50.0	20.00
R45447/64	47/64	18.65	0.7343	99.0	153.0	50.0	20.00
R45419.0	–	19.00	0.7480	99.0	153.0	50.0	20.00
R4543/4	3/4	19.05	0.7500	99.0	153.0	50.0	20.00
R45419.5	–	19.50	0.7677	99.0	153.0	50.0	20.00
R45419.8	–	19.80	0.7795	99.0	153.0	50.0	20.00
R45420.0	–	20.00	0.7874	99.0	153.0	50.0	20.00



R453



FORCE X Monolitní karbidový vrták 5xD s vnitřním chlazením, Povlakovaný TiAlN

Produktivní vrták pro kvalitní a přesné otvory, vhodný pro vysoké řezné rychlosti a velké posuvy (tolerance otvorů H9). Vrcholový úhel 140°, konstrukce se 4 fazetkami a spec. drážkou pro snazší proniknutí do materiálu. Vnitřní chlazení zlepšuje odvod třísek. Povlak TiAlN zvyšuje tvrdost povrchu nástroje a prodlužuje životnost.

FORCE X

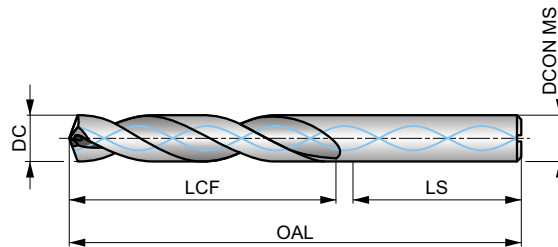

HM	DIN 6537L	5xD
140°	TiAlN	DIN 6535HA
GTW	DC m7	

Skupiny obráběných materiálů, startovní řezná rychlost (Vc m/min) a kód posuvu. Tabulku s posuvem na otáčku naleznete od strany 65.

P1.1 ■ 170 V	P1.2 ■ 190 V	P1.3 ■ 197 V	P2.1 ■ 145 V	P2.2 ■ 128 V	P2.3 ■ 113 V	P3.1 ■ 126 V	P3.2 ■ 102 V	P3.3 ■ 86 V	P4.1 ■ 75 V	P4.2 ■ 64 V	P4.3 ■ 52 U	M1.1 ■ 71 V	M1.2 ■ 61 V
M2.1 ■ 64 V	M2.2 ■ 52 V	M2.3 ■ 44 U	M3.1 ■ 39 V	M3.2 ■ 33 V	M3.3 ■ 30 V	M4.1 ■ 29 U	M4.2 ■ 25 U	K1.1 ■ 105 W	K1.2 ■ 77 W	K1.3 ■ 58 W	K2.1 ■ 93 V	K2.2 ■ 76 V	K2.3 ■ 61 V
K3.1 ■ 83 V	K3.2 ■ 64 V	K3.3 ■ 51 V	K4.1 ■ 77 V	K4.2 ■ 58 V	K4.3 ■ 43 V	K4.4 ■ 36 V	K4.5 ■ 30 V	K5.1 ■ 86 V	K5.2 ■ 66 V	K5.3 ■ 50 V	N1.1 ■ 238 W	N1.2 ■ 179 W	N1.3 ■ 119 W
N2.1 ■ 293 V	N2.2 ■ 263 V	N2.3 ■ 190 V	N3.1 ■ 354 W	N3.2 ■ 209 W	N3.3 ■ 105 W	S1.1 ■ 52 V	S1.2 ■ 43 V	S1.3 ■ 38 U	H1.1 ■ 53 U	H2.1 ■ 31 U	H2.2 ■ 29 U	H3.1 ■ 35 U	H3.2 ■ 29 U

DCON MS v toleranci h6.

Produkt	DC	DC	DC	LCF	OAL	LS	DCON MS
	(inch)	(mm)	(inch)	(mm)	(mm)	(mm)	(mm)
R4533.0	–	3.00	0.1181	28.0	66.0	36.0	6.00
R4533.1	–	3.10	0.1220	28.0	66.0	36.0	6.00
R4531/8	1/8	3.18	0.1250	28.0	66.0	36.0	6.00
R4533.2	–	3.20	0.1260	28.0	66.0	36.0	6.00
R453N30	N30	3.26	0.1283	28.0	66.0	36.0	6.00
R4533.3	–	3.30	0.1299	28.0	66.0	36.0	6.00
R4533.4	–	3.40	0.1339	28.0	66.0	36.0	6.00
R453N29	N29	3.45	0.1360	28.0	66.0	36.0	6.00
R4533.5	–	3.50	0.1378	28.0	66.0	36.0	6.00
R453N28	N28	3.57	0.1406	28.0	66.0	36.0	6.00
R4539/64	9/64	3.57	0.1406	28.0	66.0	36.0	6.00
R4533.6	–	3.60	0.1417	28.0	66.0	36.0	6.00
R453N27	N27	3.66	0.1441	28.0	66.0	36.0	6.00
R4533.7	–	3.70	0.1457	28.0	66.0	36.0	6.00
R453N26	N26	3.73	0.1469	36.0	74.0	36.0	6.00
R453N25	N25	3.80	0.1496	36.0	74.0	36.0	6.00
R4533.8	–	3.80	0.1496	36.0	74.0	36.0	6.00
R453N24	N24	3.86	0.1520	36.0	74.0	36.0	6.00
R4533.9	–	3.90	0.1535	36.0	74.0	36.0	6.00
R453N23	N23	3.91	0.1539	36.0	74.0	36.0	6.00
R4535/32	5/32	3.97	0.1563	36.0	74.0	36.0	6.00
R453N22	N22	3.99	0.1571	36.0	74.0	36.0	6.00
R4534.0	–	4.00	0.1575	36.0	74.0	36.0	6.00
R453N21	N21	4.04	0.1591	36.0	74.0	36.0	6.00
R4534.05	–	4.05	0.1594	36.0	74.0	36.0	6.00



Produkt	DC	DC	DC	LCF	OAL	LS	DCON MS
	(inch)	(mm)	(inch)	(mm)	(mm)	(mm)	(mm)
R453N20	N20	4.09	0.1610	36.0	74.0	36.0	6.00
R4534.1	–	4.10	0.1614	36.0	74.0	36.0	6.00
R4534.2	–	4.20	0.1654	36.0	74.0	36.0	6.00
R453N19	N19	4.22	0.1661	36.0	74.0	36.0	6.00
R4534.3	–	4.30	0.1693	36.0	74.0	36.0	6.00
R453N18	N18	4.31	0.1697	36.0	74.0	36.0	6.00
R45311/64	11/64	4.37	0.1719	36.0	74.0	36.0	6.00
R453N17	N17	4.39	0.1728	36.0	74.0	36.0	6.00
R4534.4	–	4.40	0.1732	36.0	74.0	36.0	6.00
R4534.5	–	4.50	0.1772	36.0	74.0	36.0	6.00
R453N16	N16	4.50	0.1772	36.0	74.0	36.0	6.00
R453N15	N15	4.57	0.1799	36.0	74.0	36.0	6.00
R4534.6	–	4.60	0.1811	36.0	74.0	36.0	6.00
R453N14	N14	4.62	0.1819	36.0	74.0	36.0	6.00
R453N13	N13	4.70	0.1850	36.0	74.0	36.0	6.00
R4534.7	–	4.70	0.1850	36.0	74.0	36.0	6.00
R4533/16	3/16	4.76	0.1875	44.0	82.0	36.0	6.00
R4534.8	–	4.80	0.1890	44.0	82.0	36.0	6.00
R453N12	N12	4.80	0.1890	44.0	82.0	36.0	6.00
R453N11	N11	4.85	0.1909	44.0	82.0	36.0	6.00
R4534.9	–	4.90	0.1929	44.0	82.0	36.0	6.00
R453N10	N10	4.92	0.1937	44.0	82.0	36.0	6.00
R453N9	N9	4.98	0.1961	44.0	82.0	36.0	6.00
R4535.0	–	5.00	0.1969	44.0	82.0	36.0	6.00
R4535.05	–	5.05	0.1988	44.0	82.0	36.0	6.00
R453N8	N8	5.06	0.1992	44.0	82.0	36.0	6.00
R4535.1	–	5.10	0.2008	44.0	82.0	36.0	6.00
R453N7	N7	5.11	0.2010	44.0	82.0	36.0	6.00
R45313/64	13/64	5.16	0.2031	44.0	82.0	36.0	6.00
R453N6	N6	5.18	0.2039	44.0	82.0	36.0	6.00
R4535.2	–	5.20	0.2047	44.0	82.0	36.0	6.00
R453N5	N5	5.22	0.2055	44.0	82.0	36.0	6.00
R4535.3	–	5.30	0.2087	44.0	82.0	36.0	6.00
R453N4	N4	5.31	0.2091	44.0	82.0	36.0	6.00
R4535.4	–	5.40	0.2126	44.0	82.0	36.0	6.00
R453N3	N3	5.41	0.2130	44.0	82.0	36.0	6.00
R4535.5	–	5.50	0.2165	44.0	82.0	36.0	6.00
R4537/32	7/32	5.56	0.2188	44.0	82.0	36.0	6.00
R4535.6	–	5.60	0.2205	44.0	82.0	36.0	6.00
R453N2	N2	5.61	0.2209	44.0	82.0	36.0	6.00
R4535.7	–	5.70	0.2244	44.0	82.0	36.0	6.00
R453N1	N1	5.79	0.2280	44.0	82.0	36.0	6.00
R4535.8	–	5.80	0.2283	44.0	82.0	36.0	6.00
R4535.9	–	5.90	0.2323	44.0	82.0	36.0	6.00
R453A	A	5.94	0.2339	44.0	82.0	36.0	6.00
R45315/64	15/64	5.95	0.2344	44.0	82.0	36.0	6.00
R4536.0	–	6.00	0.2362	44.0	82.0	36.0	6.00
R453B	B	6.05	0.2380	53.0	91.0	36.0	8.00
R4536.05	–	6.05	0.2382	53.0	91.0	36.0	8.00
R4536.1	–	6.10	0.2402	53.0	91.0	36.0	8.00
R453C	C	6.15	0.2421	53.0	91.0	36.0	8.00
R4536.2	–	6.20	0.2441	53.0	91.0	36.0	8.00
R453D	D	6.25	0.2461	53.0	91.0	36.0	8.00
R4536.3	–	6.30	0.2480	53.0	91.0	36.0	8.00
R4531/4	1/4	6.35	0.2500	53.0	91.0	36.0	8.00
R453E	E	6.35	0.2500	53.0	91.0	36.0	8.00
R4536.4	–	6.40	0.2520	53.0	91.0	36.0	8.00
R4536.5	–	6.50	0.2559	53.0	91.0	36.0	8.00
R453F	F	6.53	0.2571	53.0	91.0	36.0	8.00
R4536.6	–	6.60	0.2598	53.0	91.0	36.0	8.00
R453G	G	6.63	0.2610	53.0	91.0	36.0	8.00
R4536.7	–	6.70	0.2638	53.0	91.0	36.0	8.00
R45317/64	17/64	6.75	0.2656	53.0	91.0	36.0	8.00
R453H	H	6.76	0.2661	53.0	91.0	36.0	8.00
R4536.8	–	6.80	0.2677	53.0	91.0	36.0	8.00



Produkt	DC	DC	DC	LCF	OAL	LS	DCON MS
	(inch)	(mm)	(inch)	(mm)	(mm)	(mm)	(mm)
R4536.9	–	6.90	0.2717	53.0	91.0	36.0	8.00
R453I	I	6.91	0.2720	53.0	91.0	36.0	8.00
R4537.0	–	7.00	0.2756	53.0	91.0	36.0	8.00
R453J	J	7.04	0.2772	53.0	91.0	36.0	8.00
R4537.1	–	7.10	0.2795	53.0	91.0	36.0	8.00
R453K	K	7.14	0.2811	53.0	91.0	36.0	8.00
R4539/32	9/32	7.14	0.2813	53.0	91.0	36.0	8.00
R4537.2	–	7.20	0.2835	53.0	91.0	36.0	8.00
R4537.3	–	7.30	0.2874	53.0	91.0	36.0	8.00
R453L	L	7.37	0.2902	53.0	91.0	36.0	8.00
R4537.4	–	7.40	0.2913	53.0	91.0	36.0	8.00
R453M	M	7.49	0.2949	53.0	91.0	36.0	8.00
R4537.5	–	7.50	0.2953	53.0	91.0	36.0	8.00
R45319/64	19/64	7.54	0.2969	53.0	91.0	36.0	8.00
R4537.6	–	7.60	0.2992	53.0	91.0	36.0	8.00
R453N	N	7.67	0.3020	53.0	91.0	36.0	8.00
R4537.7	–	7.70	0.3031	53.0	91.0	36.0	8.00
R4537.8	–	7.80	0.3071	53.0	91.0	36.0	8.00
R4537.9	–	7.90	0.3110	53.0	91.0	36.0	8.00
R4535/16	5/16	7.94	0.3125	53.0	91.0	36.0	8.00
R4538.0	–	8.00	0.3150	53.0	91.0	36.0	8.00
R453O	O	8.03	0.3161	61.0	103.0	40.0	10.00
R4538.05	–	8.05	0.3169	61.0	103.0	40.0	10.00
R4538.1	–	8.10	0.3189	61.0	103.0	40.0	10.00
R4538.2	–	8.20	0.3228	61.0	103.0	40.0	10.00
R453P	P	8.20	0.3228	61.0	103.0	40.0	10.00
R4538.3	–	8.30	0.3268	61.0	103.0	40.0	10.00
R45321/64	21/64	8.33	0.3281	61.0	103.0	40.0	10.00
R4538.4	–	8.40	0.3307	61.0	103.0	40.0	10.00
R453Q	Q	8.43	0.3319	61.0	103.0	40.0	10.00
R4538.5	–	8.50	0.3346	61.0	103.0	40.0	10.00
R4538.6	–	8.60	0.3386	61.0	103.0	40.0	10.00
R453R	R	8.61	0.3390	61.0	103.0	40.0	10.00
R4538.7	–	8.70	0.3425	61.0	103.0	40.0	10.00
R45311/32	11/32	8.73	0.3438	61.0	103.0	40.0	10.00
R4538.8	–	8.80	0.3465	61.0	103.0	40.0	10.00
R453S	S	8.84	0.3480	61.0	103.0	40.0	10.00
R4538.9	–	8.90	0.3504	61.0	103.0	40.0	10.00
R4539.0	–	9.00	0.3543	61.0	103.0	40.0	10.00
R453T	T	9.09	0.3579	61.0	103.0	40.0	10.00
R4539.1	–	9.10	0.3583	61.0	103.0	40.0	10.00
R45323/64	23/64	9.13	0.3594	61.0	103.0	40.0	10.00
R4539.2	–	9.20	0.3622	61.0	103.0	40.0	10.00
R4539.3	–	9.30	0.3661	61.0	103.0	40.0	10.00
R453U	U	9.35	0.3681	61.0	103.0	40.0	10.00
R4539.4	–	9.40	0.3701	61.0	103.0	40.0	10.00
R4539.5	–	9.50	0.3740	61.0	103.0	40.0	10.00
R4533/8	3/8	9.53	0.3750	61.0	103.0	40.0	10.00
R453V	V	9.58	0.3772	61.0	103.0	40.0	10.00
R4539.6	–	9.60	0.3780	61.0	103.0	40.0	10.00
R4539.7	–	9.70	0.3819	61.0	103.0	40.0	10.00
R4539.8	–	9.80	0.3858	61.0	103.0	40.0	10.00
R453W	W	9.80	0.3858	61.0	103.0	40.0	10.00
R4539.9	–	9.90	0.3898	61.0	103.0	40.0	10.00
R45325/64	25/64	9.92	0.3906	61.0	103.0	40.0	10.00
R45310.0	–	10.00	0.3937	61.0	103.0	40.0	10.00
R45310.05	–	10.05	0.3957	70.0	118.0	45.0	12.00
R453X	X	10.08	0.3969	70.0	118.0	45.0	12.00
R45310.1	–	10.10	0.3976	70.0	118.0	45.0	12.00
R45310.2	–	10.20	0.4016	70.0	118.0	45.0	12.00
R453Y	Y	10.26	0.4039	70.0	118.0	45.0	12.00
R45310.3	–	10.30	0.4055	70.0	118.0	45.0	12.00
R45313/32	13/32	10.32	0.4063	70.0	118.0	45.0	12.00
R45310.4	–	10.40	0.4094	70.0	118.0	45.0	12.00
R453Z	Z	10.49	0.4130	70.0	118.0	45.0	12.00



Produkt	DC	DC	DC	LCF	OAL	LS	DCON MS
	(inch)	(mm)	(inch)	(mm)	(mm)	(mm)	(mm)
R45310.5	–	10.50	0.4134	70.0	118.0	45.0	12.00
R45310.6	–	10.60	0.4173	70.0	118.0	45.0	12.00
R45327/64	27/64	10.72	0.4219	70.0	118.0	45.0	12.00
R45310.8	–	10.80	0.4252	70.0	118.0	45.0	12.00
R45311.0	–	11.00	0.4331	70.0	118.0	45.0	12.00
R4537/16	7/16	11.11	0.4375	70.0	118.0	45.0	12.00
R45311.2	–	11.20	0.4409	70.0	118.0	45.0	12.00
R45311.3	–	11.30	0.4449	70.0	118.0	45.0	12.00
R45311.4	–	11.40	0.4488	70.0	118.0	45.0	12.00
R45311.5	–	11.50	0.4528	70.0	118.0	45.0	12.00
R45329/64	29/64	11.51	0.4531	70.0	118.0	45.0	12.00
R45311.6	–	11.60	0.4567	70.0	118.0	45.0	12.00
R45311.8	–	11.80	0.4646	70.0	118.0	45.0	12.00
R45315/32	15/32	11.91	0.4688	70.0	118.0	45.0	12.00
R45312.0	–	12.00	0.4724	70.0	118.0	45.0	12.00
R45312.05	–	12.05	0.4744	76.0	124.0	45.0	14.00
R45312.2	–	12.20	0.4803	76.0	124.0	45.0	14.00
R45331/64	31/64	12.30	0.4844	76.0	124.0	45.0	14.00
R45312.5	–	12.50	0.4921	76.0	124.0	45.0	14.00
R45312.7	–	12.70	0.5000	76.0	124.0	45.0	14.00
R4531/2	1/2	12.70	0.5000	76.0	124.0	45.0	14.00
R45312.8	–	12.80	0.5039	76.0	124.0	45.0	14.00
R45313.0	–	13.00	0.5118	76.0	124.0	45.0	14.00
R45333/64	33/64	13.10	0.5156	76.0	124.0	45.0	14.00
R45313.3	–	13.30	0.5236	76.0	124.0	45.0	14.00
R45317/32	17/32	13.49	0.5313	76.0	124.0	45.0	14.00
R45313.5	–	13.50	0.5315	76.0	124.0	45.0	14.00
R45313.8	–	13.80	0.5433	76.0	124.0	45.0	14.00
R45335/64	35/64	13.89	0.5469	76.0	124.0	45.0	14.00
R45314.0	–	14.00	0.5512	76.0	124.0	45.0	14.00
R45314.25	–	14.25	0.5610	82.0	133.0	48.0	16.00
R4539/16	9/16	14.29	0.5625	82.0	133.0	48.0	16.00
R45314.5	–	14.50	0.5709	82.0	133.0	48.0	16.00
R45337/64	37/64	14.68	0.5781	82.0	133.0	48.0	16.00
R45314.8	–	14.80	0.5827	82.0	133.0	48.0	16.00
R45315.0	–	15.00	0.5906	82.0	133.0	48.0	16.00
R45319/32	19/32	15.08	0.5938	82.0	133.0	48.0	16.00
R45315.1	–	15.10	0.5945	82.0	133.0	48.0	16.00
R45315.3	–	15.30	0.6024	82.0	133.0	48.0	16.00
R45339/64	39/64	15.48	0.6094	82.0	133.0	48.0	16.00
R45315.5	–	15.50	0.6102	82.0	133.0	48.0	16.00
R45315.8	–	15.80	0.6220	82.0	133.0	48.0	16.00
R4535/8	5/8	15.88	0.6250	82.0	133.0	48.0	16.00
R45316.0	–	16.00	0.6299	82.0	133.0	48.0	16.00
R45341/64	41/64	16.27	0.6406	91.0	143.0	48.0	18.00
R45316.5	–	16.50	0.6496	91.0	143.0	48.0	18.00
R45321/32	21/32	16.67	0.6563	91.0	143.0	48.0	18.00
R45317.0	–	17.00	0.6693	91.0	143.0	48.0	18.00
R45343/64	43/64	17.07	0.6720	91.0	143.0	48.0	18.00
R45311/16	11/16	17.46	0.6874	91.0	143.0	48.0	18.00
R45317.5	–	17.50	0.6890	91.0	143.0	48.0	18.00
R45317.8	–	17.80	0.7008	91.0	143.0	48.0	18.00
R45345/64	45/64	17.86	0.7031	91.0	143.0	48.0	18.00
R45318.0	–	18.00	0.7087	91.0	143.0	48.0	18.00
R45323/32	23/32	18.26	0.7189	99.0	143.0	48.0	20.00
R45318.5	–	18.50	0.7283	99.0	153.0	50.0	20.00
R45347/64	47/64	18.65	0.7343	99.0	153.0	50.0	20.00
R45319.0	–	19.00	0.7480	99.0	153.0	50.0	20.00
R4533/4	3/4	19.05	0.7500	99.0	153.0	50.0	20.00
R45319.5	–	19.50	0.7677	99.0	153.0	50.0	20.00
R45319.8	–	19.80	0.7795	99.0	153.0	50.0	20.00
R45320.0	–	20.00	0.7874	99.0	153.0	50.0	20.00



R459



FORCE X Monolitní karbidový vrták 8xD s vnitřním chlazením, Povlakovaný TiAlN

Produktivní vrták pro kvalitní a přesné otvory, vhodný pro vysoké řezné rychlosti a velké posuvy (tolerance otvorů H9). Vrcholový úhel 140°, konstrukce se 4 fazetkami a spec. drážkou pro snazší proniknutí do materiálu. Vnitřní chlazení zlepšuje odvod třísek. Povlak TiAlN zvyšuje tvrdost povrchu nástroje a prodlužuje životnost.

FORCE X

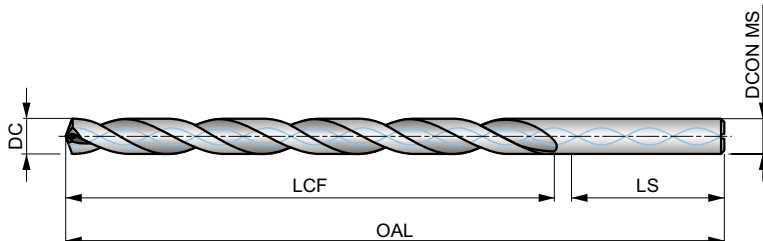

HM	DORMER	8xD
140°	TiAlN	DIN 6535HA
GTW	DC m7	

Skupiny obráběných materiálů, startovní řezná rychlost (Vc m/min) a kód posuvu. Tabulku s posuvem na otáčku naleznete od strany 65.

P1.1 ■ 143 V	P1.2 ■ 160 V	P1.3 ■ 166 V	P2.1 ■ 122 V	P2.2 ■ 108 U	P2.3 ■ 95 U	P3.1 ■ 106 U	P3.2 ■ 86 U	P3.3 ■ 72 U	P4.1 ■ 63 U	P4.2 ■ 54 U	P4.3 ■ 44 T	M1.1 ■ 60 V	M1.2 ■ 51 V
M2.1 ■ 154 V	M2.2 ■ 44 V	M2.3 ■ 37 U	M3.1 ■ 33 V	M3.2 ■ 28 V	M3.3 ■ 26 V	M4.1 ■ 24 U	M4.2 ■ 21 U	K1.1 ■ 88 W	K1.2 ■ 65 W	K1.3 ■ 49 W	K2.1 ■ 78 V	K2.2 ■ 64 V	K2.3 ■ 51 V
K3.1 ■ 70 V	K3.2 ■ 54 V	K3.3 ■ 43 V	K4.1 ■ 65 V	K4.2 ■ 49 V	K4.3 ■ 36 V	K4.4 ■ 30 V	K4.5 ■ 26 V	K5.1 ■ 73 V	K5.2 ■ 55 V	K5.3 ■ 42 V	N1.1 ■ 200 W	N1.2 ■ 150 W	N1.3 ■ 100 W
N2.1 ■ 246 V	N2.2 ■ 222 V	N2.3 ■ 160 V	N3.1 ■ 298 V	N3.2 ■ 176 V	N3.3 ■ 188 V								

DCON MS v toleranci h6.

Produkt	DC (inch)	DC (mm)	DC (inch)	LCF (mm)	OAL (mm)	LS (mm)	DCON MS (mm)
R4593.0	–	3.00	0.1181	37.0	79.0	36.0	6.00
R4593.1	–	3.10	0.1220	37.0	79.0	36.0	6.00
R4591/8	1/8	3.18	0.1250	37.0	79.0	36.0	6.00
R4593.2	–	3.20	0.1260	37.0	79.0	36.0	6.00
R4593.3	–	3.30	0.1299	37.0	79.0	36.0	6.00
R4593.4	–	3.40	0.1339	37.0	79.0	36.0	6.00
R4593.5	–	3.50	0.1378	37.0	79.0	36.0	6.00
R4599/64	9/64	3.57	0.1406	37.0	79.0	36.0	6.00
R4593.6	–	3.60	0.1417	37.0	79.0	36.0	6.00
R4593.7	–	3.70	0.1457	37.0	79.0	36.0	6.00
R4593.8	–	3.80	0.1496	48.0	90.0	36.0	6.00
R4593.9	–	3.90	0.1535	48.0	90.0	36.0	6.00
R4595/32	5/32	3.97	0.1563	48.0	90.0	36.0	6.00
R4594.0	–	4.00	0.1575	48.0	90.0	36.0	6.00
R4594.1	–	4.10	0.1614	48.0	90.0	36.0	6.00
R4594.2	–	4.20	0.1654	48.0	90.0	36.0	6.00
R4594.3	–	4.30	0.1693	48.0	90.0	36.0	6.00
R45911/64	11/64	4.37	0.1719	48.0	90.0	36.0	6.00
R4594.4	–	4.40	0.1732	48.0	90.0	36.0	6.00
R4594.5	–	4.50	0.1772	48.0	90.0	36.0	6.00
R4594.6	–	4.60	0.1811	48.0	90.0	36.0	6.00
R4594.7	–	4.70	0.1850	62.0	104.0	36.0	6.00
R4593/16	3/16	4.76	0.1875	62.0	104.0	36.0	6.00
R4594.8	–	4.80	0.1890	62.0	104.0	36.0	6.00
R4594.9	–	4.90	0.1929	62.0	104.0	36.0	6.00



Produkt	DC	DC	DC	LCF	OAL	LS	DCON MS
	(inch)	(mm)	(inch)	(mm)	(mm)	(mm)	(mm)
R4595.0	–	5.00	0.1969	62.0	104.0	36.0	6.00
R4595.1	–	5.10	0.2008	62.0	104.0	36.0	6.00
R45913/64	13/64	5.16	0.2031	62.0	104.0	36.0	6.00
R4595.2	–	5.20	0.2047	62.0	104.0	36.0	6.00
R4595.3	–	5.30	0.2087	62.0	104.0	36.0	6.00
R4595.4	–	5.40	0.2126	62.0	104.0	36.0	6.00
R4595.5	–	5.50	0.2165	62.0	104.0	36.0	6.00
R4597/32	7/32	5.56	0.2188	62.0	104.0	36.0	6.00
R4595.6	–	5.60	0.2205	62.0	104.0	36.0	6.00
R4595.7	–	5.70	0.2244	62.0	104.0	36.0	6.00
R4595.8	–	5.80	0.2283	62.0	104.0	36.0	6.00
R4595.9	–	5.90	0.2323	62.0	104.0	36.0	6.00
R45915/64	15/64	5.95	0.2344	62.0	104.0	36.0	6.00
R4596.0	–	6.00	0.2362	62.0	104.0	36.0	6.00
R4596.1	–	6.10	0.2402	84.0	126.0	36.0	8.00
R4596.2	–	6.20	0.2441	84.0	126.0	36.0	8.00
R4596.3	–	6.30	0.2480	84.0	126.0	36.0	8.00
R4591/4	1/4	6.35	0.2500	84.0	126.0	36.0	8.00
R4596.4	–	6.40	0.2520	84.0	126.0	36.0	8.00
R4596.5	–	6.50	0.2559	84.0	126.0	36.0	8.00
R4596.6	–	6.60	0.2598	84.0	126.0	36.0	8.00
R4596.7	–	6.70	0.2638	84.0	126.0	36.0	8.00
R45917/64	17/64	6.75	0.2656	84.0	126.0	36.0	8.00
R4596.8	–	6.80	0.2677	84.0	126.0	36.0	8.00
R4596.9	–	6.90	0.2717	84.0	126.0	36.0	8.00
R4597.0	–	7.00	0.2756	84.0	126.0	36.0	8.00
R4597.1	–	7.10	0.2795	84.0	126.0	36.0	8.00
R4599/32	9/32	7.14	0.2813	84.0	126.0	36.0	8.00
R4597.2	–	7.20	0.2835	84.0	126.0	36.0	8.00
R4597.3	–	7.30	0.2874	84.0	126.0	36.0	8.00
R4597.4	–	7.40	0.2913	84.0	126.0	36.0	8.00
R4597.5	–	7.50	0.2953	84.0	126.0	36.0	8.00
R45919/64	19/64	7.54	0.2969	84.0	126.0	36.0	8.00
R4597.6	–	7.60	0.2992	84.0	126.0	36.0	8.00
R4597.7	–	7.70	0.3031	84.0	126.0	36.0	8.00
R4597.8	–	7.80	0.3071	84.0	126.0	36.0	8.00
R4597.9	–	7.90	0.3110	84.0	126.0	36.0	8.00
R4595/16	5/16	7.94	0.3125	84.0	126.0	36.0	8.00
R4598.0	–	8.00	0.3150	84.0	126.0	36.0	8.00
R4598.1	–	8.10	0.3189	106.0	152.0	40.0	10.00
R4598.2	–	8.20	0.3228	106.0	152.0	40.0	10.00
R4598.3	–	8.30	0.3268	106.0	152.0	40.0	10.00
R45921/64	21/64	8.33	0.3281	106.0	152.0	40.0	10.00
R4598.4	–	8.40	0.3307	106.0	152.0	40.0	10.00
R4598.5	–	8.50	0.3346	106.0	152.0	40.0	10.00
R4598.6	–	8.60	0.3386	106.0	152.0	40.0	10.00
R4598.7	–	8.70	0.3425	106.0	152.0	40.0	10.00
R45911/32	11/32	8.73	0.3438	106.0	152.0	40.0	10.00
R4598.8	–	8.80	0.3465	106.0	152.0	40.0	10.00
R4598.9	–	8.90	0.3504	106.0	152.0	40.0	10.00
R4599.0	–	9.00	0.3543	106.0	152.0	40.0	10.00
R4599.1	–	9.10	0.3583	106.0	152.0	40.0	10.00
R45923/64	23/64	9.13	0.3594	106.0	152.0	40.0	10.00
R4599.2	–	9.20	0.3622	106.0	152.0	40.0	10.00
R4599.3	–	9.30	0.3661	106.0	152.0	40.0	10.00
R4599.4	–	9.40	0.3701	106.0	152.0	40.0	10.00
R4599.5	–	9.50	0.3740	106.0	152.0	40.0	10.00
R4593/8	3/8	9.53	0.3750	106.0	152.0	40.0	10.00
R4599.6	–	9.60	0.3780	106.0	152.0	40.0	10.00
R4599.7	–	9.70	0.3819	106.0	152.0	40.0	10.00
R4599.8	–	9.80	0.3858	106.0	152.0	40.0	10.00
R4599.9	–	9.90	0.3898	106.0	152.0	40.0	10.00



Produkt	DC	DC	DC	LCF	OAL	LS	DCON MS
	(inch)	(mm)	(inch)	(mm)	(mm)	(mm)	(mm)
R45925/64	25/64	9.92	0.3906	106.0	152.0	40.0	10.00
R45910.0	–	10.00	0.3937	106.0	152.0	40.0	10.00
R45910.2	–	10.20	0.4016	128.0	180.0	45.0	12.00
R45910.3	–	10.30	0.4055	128.0	180.0	45.0	12.00
R45913/32	13/32	10.32	0.4063	128.0	180.0	45.0	12.00
R45910.4	–	10.40	0.4094	128.0	180.0	45.0	12.00
R45910.5	–	10.50	0.4134	128.0	180.0	45.0	12.00
R45927/64	27/64	10.72	0.4219	128.0	180.0	45.0	12.00
R45910.8	–	10.80	0.4252	128.0	180.0	45.0	12.00
R45911.0	–	11.00	0.4331	128.0	180.0	45.0	12.00
R4597/16	7/16	11.11	0.4375	128.0	180.0	45.0	12.00
R45911.2	–	11.20	0.4409	128.0	180.0	45.0	12.00
R45911.3	–	11.30	0.4449	128.0	180.0	45.0	12.00
R45911.5	–	11.50	0.4528	128.0	180.0	45.0	12.00
R45929/64	29/64	11.51	0.4531	128.0	180.0	45.0	12.00
R45911.8	–	11.80	0.4646	128.0	180.0	45.0	12.00
R45915/32	15/32	11.91	0.4688	128.0	180.0	45.0	12.00
R45912.0	–	12.00	0.4724	128.0	180.0	45.0	12.00
R45912.2	–	12.20	0.4803	151.0	202.0	48.0	14.00
R45931/64	31/64	12.30	0.4844	151.0	202.0	48.0	14.00
R45912.5	–	12.50	0.4921	151.0	202.0	48.0	14.00
R4591/2	1/2	12.70	0.5000	151.0	202.0	48.0	14.00
R45912.8	–	12.80	0.5039	151.0	202.0	48.0	14.00
R45913.0	–	13.00	0.5118	151.0	202.0	48.0	14.00
R45933/64	33/64	13.10	0.5156	151.0	202.0	48.0	14.00
R45917/32	17/32	13.49	0.5313	151.0	202.0	48.0	14.00
R45913.5	–	13.50	0.5315	151.0	202.0	48.0	14.00
R45935/64	35/64	13.89	0.5469	151.0	202.0	48.0	14.00
R45914.0	–	14.00	0.5512	151.0	202.0	48.0	14.00
R45914.25	–	14.25	0.5610	172.0	227.0	48.0	16.00
R4599/16	9/16	14.29	0.5625	172.0	227.0	48.0	16.00
R45914.5	–	14.50	0.5709	172.0	227.0	48.0	16.00
R45937/64	37/64	14.68	0.5781	172.0	227.0	48.0	16.00
R45915.0	–	15.00	0.5906	172.0	227.0	48.0	16.00
R45919/32	19/32	15.08	0.5938	172.0	227.0	48.0	16.00
R45915.1	–	15.10	0.5945	172.0	227.0	48.0	16.00
R45939/64	39/64	15.48	0.6094	172.0	227.0	48.0	16.00
R45915.5	–	15.50	0.6102	172.0	227.0	48.0	16.00
R4595/8	5/8	15.88	0.6250	172.0	227.0	48.0	16.00
R45916.0	–	16.00	0.6299	172.0	227.0	48.0	16.00



R467

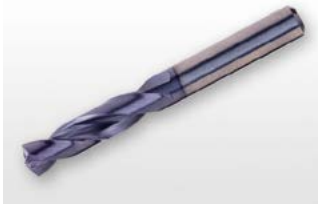

FORCE M Monolitní karbidový vrták 3xD s vnitřním chlazením, Povlakovaný TiAIN

Produktivní vrták pro kvalitní a přesné otvory, vhodný pro vysoké řezné rychlosti a velké posuvy (tolerance otvorů H9 v nerez ocelích a superslitinách). Vrcholový úhel 140°, konstrukce se 4 fazetkami a spec. drážkou CTW. Vnitřní chlazení zlepšuje odvod třísek. Povlak TiAIN zvyšuje tvrdost povrchu nástroje a prodlužuje životnost.

FORCE M

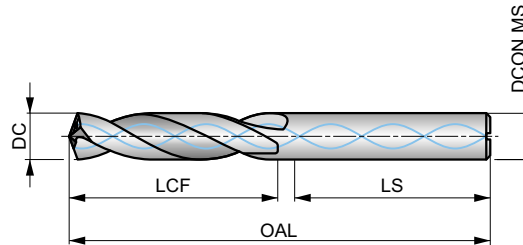

HM	DIN 6537K	3xD
140°	TiAIN	DIN 6535HA
GTW	DC m7	

Skupiny obráběných materiálů, startovní řezná rychlost (Vc m/min) a kód posuvu. Tabulku s posuvem na otáčku naleznete od strany 65.

M1.1 ■ 117 G	M1.2 ■ 99 G	M2.1 ■ 104 G	M2.2 ■ 85 G	M2.3 ■ 71 E	M3.1 ■ 87 G	M3.2 ■ 75 G	M3.3 ■ 68 F	M4.1 ■ 60 F	M4.2 ■ 52 E	S1.1 ■ 55 V	S1.2 ■ 45 V	S1.3 ■ 40 U	S2.1 ■ 60 U
S2.2 ■ 56 U	S3.1 ■ 45 U	S3.2 ■ 40 U	S4.1 ■ 35 U	S4.2 ■ 32 U									

DCON MS v toleranci h6.

Produkt	DC	DC	DC	LCF	OAL	LS	DCON MS
	(inch)	(mm)	(inch)	(mm)	(mm)	(mm)	(mm)
R4673.0	–	3.00	0.1181	20.0	62.0	36.0	6.00
R4673.1	–	3.10	0.1220	20.0	62.0	36.0	6.00
R4671/8	1/8	3.18	0.1250	20.0	62.0	36.0	6.00
R4673.2	–	3.20	0.1260	20.0	62.0	36.0	6.00
R4673.3	–	3.30	0.1299	20.0	62.0	36.0	6.00
R4673.4	–	3.40	0.1339	20.0	62.0	36.0	6.00
R467N29	N29	3.45	0.1360	20.0	62.0	36.0	6.00
R4673.5	–	3.50	0.1378	20.0	62.0	36.0	6.00
R4679/64	9/64	3.57	0.1406	20.0	62.0	36.0	6.00
R4673.6	–	3.60	0.1417	20.0	62.0	36.0	6.00
R4673.7	–	3.70	0.1457	20.0	62.0	36.0	6.00
R4673.8	–	3.80	0.1496	24.0	66.0	36.0	6.00
R4673.9	–	3.90	0.1535	24.0	66.0	36.0	6.00
R4675/32	5/32	3.97	0.1563	24.0	66.0	36.0	6.00
R4674.0	–	4.00	0.1575	24.0	66.0	36.0	6.00
R4674.05	–	4.05	0.1594	24.0	66.0	36.0	6.00
R4674.1	–	4.10	0.1614	24.0	66.0	36.0	6.00
R4674.2	–	4.20	0.1654	24.0	66.0	36.0	6.00
R4674.3	–	4.30	0.1693	24.0	66.0	36.0	6.00
R46711/64	11/64	4.37	0.1719	24.0	66.0	36.0	6.00
R4674.4	–	4.40	0.1732	24.0	66.0	36.0	6.00
R4674.5	–	4.50	0.1772	24.0	66.0	36.0	6.00
R4674.6	–	4.60	0.1811	24.0	66.0	36.0	6.00
R4674.7	–	4.70	0.1850	24.0	66.0	36.0	6.00
R4673/16	3/16	4.76	0.1875	28.0	66.0	36.0	6.00
R4674.8	–	4.80	0.1890	28.0	66.0	36.0	6.00
R4674.9	–	4.90	0.1929	28.0	66.0	36.0	6.00
R4675.0	–	5.00	0.1969	28.0	66.0	36.0	6.00
R4675.05	–	5.05	0.1988	28.0	66.0	36.0	6.00



Produkt	DC	DC	DC	LCF	OAL	LS	DCON MS
	(inch)	(mm)	(inch)	(mm)	(mm)	(mm)	(mm)
R4675.1	–	5.10	0.2008	28.0	66.0	36.0	6.00
R467N7	N7	5.11	0.2010	28.0	66.0	36.0	6.00
R46713/64	13/64	5.16	0.2031	28.0	66.0	36.0	6.00
R4675.2	–	5.20	0.2047	28.0	66.0	36.0	6.00
R467N5	N5	5.22	0.2055	28.0	66.0	36.0	6.00
R4675.3	–	5.30	0.2087	28.0	66.0	36.0	6.00
R4675.4	–	5.40	0.2126	28.0	66.0	36.0	6.00
R4675.5	–	5.50	0.2165	28.0	66.0	36.0	6.00
R4677/32	7/32	5.56	0.2188	28.0	66.0	36.0	6.00
R4675.6	–	5.60	0.2205	28.0	66.0	36.0	6.00
R4675.7	–	5.70	0.2244	28.0	66.0	36.0	6.00
R4675.8	–	5.80	0.2283	28.0	66.0	36.0	6.00
R4675.9	–	5.90	0.2323	28.0	66.0	36.0	6.00
R46715/64	15/64	5.95	0.2344	28.0	66.0	36.0	6.00
R4676.0	–	6.00	0.2362	28.0	66.0	36.0	6.00
R4676.05	–	6.05	0.2382	34.0	79.0	36.0	8.00
R4676.1	–	6.10	0.2402	34.0	79.0	36.0	8.00
R4676.2	–	6.20	0.2441	34.0	79.0	36.0	8.00
R4676.3	–	6.30	0.2480	34.0	79.0	36.0	8.00
R4671/4	1/4	6.35	0.2500	34.0	79.0	36.0	8.00
R4676.4	–	6.40	0.2520	34.0	79.0	36.0	8.00
R4676.5	–	6.50	0.2559	34.0	79.0	36.0	8.00
R4676.6	–	6.60	0.2598	34.0	79.0	36.0	8.00
R4676.7	–	6.70	0.2638	34.0	79.0	36.0	8.00
R46717/64	17/64	6.75	0.2656	34.0	79.0	36.0	8.00
R4676.8	–	6.80	0.2677	34.0	79.0	36.0	8.00
R4676.9	–	6.90	0.2717	34.0	79.0	36.0	8.00
R4677.0	–	7.00	0.2756	34.0	79.0	36.0	8.00
R4677.1	–	7.10	0.2795	41.0	79.0	36.0	8.00
R4679/32	9/32	7.14	0.2813	41.0	79.0	36.0	8.00
R4677.2	–	7.20	0.2835	41.0	79.0	36.0	8.00
R4677.3	–	7.30	0.2874	41.0	79.0	36.0	8.00
R4677.4	–	7.40	0.2913	41.0	79.0	36.0	8.00
R4677.5	–	7.50	0.2953	41.0	79.0	36.0	8.00
R46719/64	19/64	7.54	0.2969	41.0	79.0	36.0	8.00
R4677.6	–	7.60	0.2992	41.0	79.0	36.0	8.00
R4677.7	–	7.70	0.3031	41.0	79.0	36.0	8.00
R4677.8	–	7.80	0.3071	41.0	79.0	36.0	8.00
R4677.9	–	7.90	0.3110	41.0	79.0	36.0	8.00
R4675/16	5/16	7.94	0.3125	41.0	79.0	36.0	8.00
R4678.0	–	8.00	0.3150	41.0	79.0	36.0	8.00
R4678.05	–	8.05	0.3169	47.0	89.0	40.0	10.00
R4678.1	–	8.10	0.3189	47.0	89.0	40.0	10.00
R4678.2	–	8.20	0.3228	47.0	89.0	40.0	10.00
R4678.3	–	8.30	0.3268	47.0	89.0	40.0	10.00
R46721/64	21/64	8.33	0.3281	47.0	89.0	40.0	10.00
R4678.4	–	8.40	0.3307	47.0	89.0	40.0	10.00
R4678.5	–	8.50	0.3346	47.0	89.0	40.0	10.00
R4678.6	–	8.60	0.3386	47.0	89.0	40.0	10.00
R4678.7	–	8.70	0.3425	47.0	89.0	40.0	10.00
R46711/32	11/32	8.73	0.3438	47.0	89.0	40.0	10.00
R4678.8	–	8.80	0.3465	47.0	89.0	40.0	10.00
R4678.9	–	8.90	0.3504	47.0	89.0	40.0	10.00
R4679.0	–	9.00	0.3543	47.0	89.0	40.0	10.00
R4679.1	–	9.10	0.3583	47.0	89.0	40.0	10.00
R46723/64	23/64	9.13	0.3594	47.0	89.0	40.0	10.00
R4679.2	–	9.20	0.3622	47.0	89.0	40.0	10.00
R4679.3	–	9.30	0.3661	47.0	89.0	40.0	10.00
R4679.4	–	9.40	0.3701	47.0	89.0	40.0	10.00
R4679.5	–	9.50	0.3740	47.0	89.0	40.0	10.00
R4673/8	3/8	9.53	0.3750	47.0	89.0	40.0	10.00
R4679.6	–	9.60	0.3780	47.0	89.0	40.0	10.00



Produkt	DC	DC	DC	LCF	OAL	LS	DCON MS
	(inch)	(mm)	(inch)	(mm)	(mm)	(mm)	(mm)
R4679.7	–	9.70	0.3819	47.0	89.0	40.0	10.00
R4679.8	–	9.80	0.3858	47.0	89.0	40.0	10.00
R4679.9	–	9.90	0.3898	47.0	89.0	40.0	10.00
R46725/64	25/64	9.92	0.3906	47.0	89.0	40.0	10.00
R46710.0	–	10.00	0.3937	47.0	89.0	40.0	10.00
R46710.05	–	10.05	0.3957	55.0	102.0	45.0	12.00
R46710.1	–	10.10	0.3976	55.0	102.0	45.0	12.00
R46710.2	–	10.20	0.4016	55.0	102.0	45.0	12.00
R46710.3	–	10.30	0.4055	55.0	102.0	45.0	12.00
R46713/32	13/32	10.32	0.4063	55.0	102.0	45.0	12.00
R46710.4	–	10.40	0.4094	55.0	102.0	45.0	12.00
R46710.5	–	10.50	0.4134	55.0	102.0	45.0	12.00
R46710.6	–	10.60	0.4173	55.0	102.0	45.0	12.00
R46727/64	27/64	10.72	0.4219	55.0	102.0	45.0	12.00
R46710.8	–	10.80	0.4252	55.0	102.0	45.0	12.00
R46710.9	–	10.90	0.4291	55.0	102.0	45.0	12.00
R46711.0	–	11.00	0.4331	55.0	102.0	45.0	12.00
R4677/16	7/16	11.11	0.4375	55.0	102.0	45.0	12.00
R46711.2	–	11.20	0.4409	55.0	102.0	45.0	12.00
R46711.3	–	11.30	0.4449	55.0	102.0	45.0	12.00
R46711.4	–	11.40	0.4488	55.0	102.0	45.0	12.00
R46711.5	–	11.50	0.4528	55.0	102.0	45.0	12.00
R46729/64	29/64	11.51	0.4531	55.0	102.0	45.0	12.00
R46711.6	–	11.60	0.4567	55.0	102.0	45.0	12.00
R46711.8	–	11.80	0.4646	55.0	102.0	45.0	12.00
R46715/32	15/32	11.91	0.4688	55.0	102.0	45.0	12.00
R46712.0	–	12.00	0.4724	55.0	102.0	45.0	12.00
R46712.05	–	12.05	0.4744	60.0	107.0	45.0	14.00
R46712.1	–	12.10	0.4764	60.0	107.0	45.0	14.00
R46712.2	–	12.20	0.4803	60.0	107.0	45.0	14.00
R46731/64	31/64	12.30	0.4844	60.0	107.0	45.0	14.00
R46712.5	–	12.50	0.4921	60.0	107.0	45.0	14.00
R46712.7	–	12.70	0.5000	60.0	107.0	45.0	14.00
R4671/2	1/2	12.70	0.5000	60.0	107.0	45.0	14.00
R46712.8	–	12.80	0.5039	60.0	107.0	45.0	14.00
R46713.0	–	13.00	0.5118	60.0	107.0	45.0	14.00
R46733/64	33/64	13.10	0.5156	60.0	107.0	45.0	14.00
R46713.3	–	13.30	0.5236	60.0	107.0	45.0	14.00
R46717/32	17/32	13.49	0.5313	60.0	107.0	45.0	14.00
R46713.5	–	13.50	0.5315	60.0	107.0	45.0	14.00
R46713.8	–	13.80	0.5433	60.0	107.0	45.0	14.00
R46735/64	35/64	13.89	0.5469	60.0	107.0	45.0	14.00
R46714.0	–	14.00	0.5512	60.0	107.0	45.0	14.00
R46714.25	–	14.25	0.5610	65.0	115.0	48.0	16.00
R4679/16	9/16	14.29	0.5625	65.0	115.0	48.0	16.00
R46714.5	–	14.50	0.5709	65.0	115.0	48.0	16.00
R46737/64	37/64	14.68	0.5781	65.0	115.0	48.0	16.00
R46714.8	–	14.80	0.5827	65.0	115.0	48.0	16.00
R46715.0	–	15.00	0.5906	65.0	115.0	48.0	16.00
R46719/32	19/32	15.08	0.5938	65.0	115.0	48.0	16.00
R46715.1	–	15.10	0.5945	65.0	115.0	48.0	16.00
R46715.3	–	15.30	0.6024	65.0	115.0	48.0	16.00
R46739/64	39/64	15.48	0.6094	65.0	115.0	48.0	16.00
R46715.5	–	15.50	0.6102	65.0	115.0	48.0	16.00
R46715.8	–	15.80	0.6220	65.0	115.0	48.0	16.00
R4675/8	5/8	15.88	0.6250	65.0	115.0	48.0	16.00
R46716.0	–	16.00	0.6299	65.0	115.0	48.0	16.00



R463



FORCE M Monolitní karbidový vrták 5xD s vnitřním chlazením, Povlakovaný TiAlN

Produktivní vrták pro kvalitní a přesné otvory, vhodný pro vysoké řezné rychlosti a velké posuvy (tolerance otvorů H9 v nerez ocelích a superslitinách). Vrcholový úhel 140°, konstrukce se 4 fazetkami a spec. drážkou CTW. Vnitřní chlazení zlepšuje odvod třísek. Povlak TiAlN zvyšuje tvrdost povrchu nástroje a prodlužuje životnost.

FORCE M

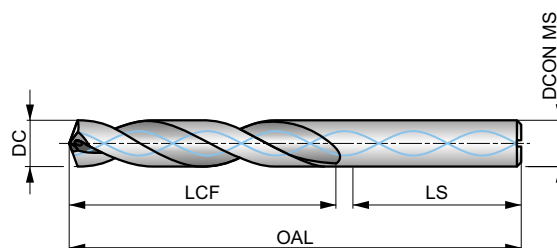

HM	DIN 6537L	5xD
140°	TiAlN	DIN 6535HA
CTW	DC m7	

Skupiny obráběných materiálů, startovní řezná rychlost (Vc m/min) a kód posuvu. Tabulku s posuvem na otáčku naleznete od strany 65.

M1.1 ■ 111 G	M1.2 ■ 94 G	M2.1 ■ 99 G	M2.2 ■ 81 G	M2.3 ■ 67 E	M3.1 ■ 83 G	M3.2 ■ 71 G	M3.3 ■ 65 F	M4.1 ■ 57 F	M4.2 ■ 49 E	S1.1 ■ 52 V	S1.2 ■ 43 V	S1.3 ■ 38 U	S2.1 ■ 57 U
S2.2 ■ 53 U	S3.1 ■ 43 U	S3.2 ■ 38 U	S4.1 ■ 33 U	S4.2 ■ 30 U									

DCON MS v toleranci h6.

Produkt	DC	DC	DC	LCF	OAL	LS	DCON MS
	(inch)	(mm)	(inch)	(mm)	(mm)	(mm)	
R4633.0	–	3.00	0.1181	28.0	66.0	36.0	6.00
R4633.1	–	3.10	0.1220	28.0	66.0	36.0	6.00
R4631/8	1/8	3.18	0.1250	28.0	66.0	36.0	6.00
R4633.2	–	3.20	0.1260	28.0	66.0	36.0	6.00
R4633.3	–	3.30	0.1299	28.0	66.0	36.0	6.00
R4633.4	–	3.40	0.1339	28.0	66.0	36.0	6.00
R463N29	N29	3.45	0.1360	28.0	66.0	36.0	6.00
R4633.5	–	3.50	0.1378	28.0	66.0	36.0	6.00
R4639/64	9/64	3.57	0.1406	28.0	66.0	36.0	6.00
R4633.6	–	3.60	0.1417	28.0	66.0	36.0	6.00
R4633.7	–	3.70	0.1457	28.0	66.0	36.0	6.00
R4633.8	–	3.80	0.1496	36.0	74.0	36.0	6.00
R4633.9	–	3.90	0.1535	36.0	74.0	36.0	6.00
R4635/32	5/32	3.97	0.1563	36.0	74.0	36.0	6.00
R4634.0	–	4.00	0.1575	36.0	74.0	36.0	6.00
R4634.05	–	4.05	0.1594	36.0	74.0	36.0	6.00
R4634.1	–	4.10	0.1614	36.0	74.0	36.0	6.00
R4634.2	–	4.20	0.1654	36.0	74.0	36.0	6.00
R4634.3	–	4.30	0.1693	36.0	74.0	36.0	6.00
R46311/64	11/64	4.37	0.1719	36.0	74.0	36.0	6.00
R4634.4	–	4.40	0.1732	36.0	74.0	36.0	6.00
R4634.5	–	4.50	0.1772	36.0	74.0	36.0	6.00
R4634.6	–	4.60	0.1811	36.0	74.0	36.0	6.00
R4634.7	–	4.70	0.1850	36.0	74.0	36.0	6.00
R4633/16	3/16	4.76	0.1875	44.0	82.0	36.0	6.00
R4634.8	–	4.80	0.1890	44.0	82.0	36.0	6.00
R4634.9	–	4.90	0.1929	44.0	82.0	36.0	6.00
R4635.0	–	5.00	0.1969	44.0	82.0	36.0	6.00
R4635.05	–	5.05	0.1988	44.0	82.0	36.0	6.00



Produkt	DC	DC	DC	LCF	OAL	LS	DCON MS
	(inch)	(mm)	(inch)	(mm)	(mm)	(mm)	(mm)
R4635.1	–	5.10	0.2008	44.0	82.0	36.0	6.00
R463N7	N7	5.11	0.2010	44.0	82.0	36.0	6.00
R46313/64	13/64	5.16	0.2031	44.0	82.0	36.0	6.00
R4635.2	–	5.20	0.2047	44.0	82.0	36.0	6.00
R463N5	N5	5.22	0.2055	44.0	82.0	36.0	6.00
R4635.3	–	5.30	0.2087	44.0	82.0	36.0	6.00
R4635.4	–	5.40	0.2126	44.0	82.0	36.0	6.00
R4635.5	–	5.50	0.2165	44.0	82.0	36.0	6.00
R4637/32	7/32	5.56	0.2188	44.0	82.0	36.0	6.00
R4635.6	–	5.60	0.2205	44.0	82.0	36.0	6.00
R4635.7	–	5.70	0.2244	44.0	82.0	36.0	6.00
R4635.8	–	5.80	0.2283	44.0	82.0	36.0	6.00
R4635.9	–	5.90	0.2323	44.0	82.0	36.0	6.00
R46315/64	15/64	5.95	0.2344	44.0	82.0	36.0	6.00
R4636.0	–	6.00	0.2362	44.0	82.0	36.0	6.00
R4636.05	–	6.05	0.2382	53.0	91.0	36.0	8.00
R4636.1	–	6.10	0.2402	53.0	91.0	36.0	8.00
R4636.2	–	6.20	0.2441	53.0	91.0	36.0	8.00
R4636.3	–	6.30	0.2480	53.0	91.0	36.0	8.00
R4631/4	1/4	6.35	0.2500	53.0	91.0	36.0	8.00
R4636.4	–	6.40	0.2520	53.0	91.0	36.0	8.00
R4636.5	–	6.50	0.2559	53.0	91.0	36.0	8.00
R4636.6	–	6.60	0.2598	53.0	91.0	36.0	8.00
R4636.7	–	6.70	0.2638	53.0	91.0	36.0	8.00
R46317/64	17/64	6.75	0.2656	53.0	91.0	36.0	8.00
R4636.8	–	6.80	0.2677	53.0	91.0	36.0	8.00
R4636.9	–	6.90	0.2717	53.0	91.0	36.0	8.00
R4637.0	–	7.00	0.2756	53.0	91.0	36.0	8.00
R4637.1	–	7.10	0.2795	53.0	91.0	36.0	8.00
R4639/32	9/32	7.14	0.2813	53.0	91.0	36.0	8.00
R4637.2	–	7.20	0.2835	53.0	91.0	36.0	8.00
R4637.3	–	7.30	0.2874	53.0	91.0	36.0	8.00
R4637.4	–	7.40	0.2913	53.0	91.0	36.0	8.00
R4637.5	–	7.50	0.2953	53.0	91.0	36.0	8.00
R46319/64	19/64	7.54	0.2969	53.0	91.0	36.0	8.00
R4637.6	–	7.60	0.2992	53.0	91.0	36.0	8.00
R4637.7	–	7.70	0.3031	53.0	91.0	36.0	8.00
R4637.8	–	7.80	0.3071	53.0	91.0	36.0	8.00
R4637.9	–	7.90	0.3110	53.0	91.0	36.0	8.00
R4635/16	5/16	7.94	0.3125	53.0	91.0	36.0	8.00
R4638.0	–	8.00	0.3150	53.0	91.0	36.0	8.00
R4638.05	–	8.05	0.3169	61.0	103.0	40.0	10.00
R4638.1	–	8.10	0.3189	61.0	103.0	40.0	10.00
R4638.2	–	8.20	0.3228	61.0	103.0	40.0	10.00
R4638.3	–	8.30	0.3268	61.0	103.0	40.0	10.00
R46321/64	21/64	8.33	0.3281	61.0	103.0	40.0	10.00
R4638.4	–	8.40	0.3307	61.0	103.0	40.0	10.00
R4638.5	–	8.50	0.3346	61.0	103.0	40.0	10.00
R4638.6	–	8.60	0.3386	61.0	103.0	40.0	10.00
R4638.7	–	8.70	0.3425	61.0	103.0	40.0	10.00
R46311/32	11/32	8.73	0.3438	61.0	103.0	40.0	10.00
R4638.8	–	8.80	0.3465	61.0	103.0	40.0	10.00
R4638.9	–	8.90	0.3504	61.0	103.0	40.0	10.00
R4639.0	–	9.00	0.3543	61.0	103.0	40.0	10.00
R4639.1	–	9.10	0.3583	61.0	103.0	40.0	10.00
R46323/64	23/64	9.13	0.3594	61.0	103.0	40.0	10.00
R4639.2	–	9.20	0.3622	61.0	103.0	40.0	10.00
R4639.3	–	9.30	0.3661	61.0	103.0	40.0	10.00
R4639.4	–	9.40	0.3701	61.0	103.0	40.0	10.00
R4639.5	–	9.50	0.3740	61.0	103.0	40.0	10.00
R4633/8	3/8	9.53	0.3750	61.0	103.0	40.0	10.00
R4639.6	–	9.60	0.3780	61.0	103.0	40.0	10.00



Produkt	DC	DC	DC	LCF	OAL	LS	DCON MS
	(inch)	(mm)	(inch)	(mm)	(mm)	(mm)	(mm)
R4639.7	–	9.70	0.3819	61.0	103.0	40.0	10.00
R4639.8	–	9.80	0.3858	61.0	103.0	40.0	10.00
R4639.9	–	9.90	0.3898	61.0	103.0	40.0	10.00
R46325/64	25/64	9.92	0.3906	61.0	103.0	40.0	10.00
R46310.0	–	10.00	0.3937	61.0	103.0	40.0	10.00
R46310.05	–	10.05	0.3957	70.0	118.0	45.0	12.00
R46310.1	–	10.10	0.3976	70.0	118.0	45.0	12.00
R46310.2	–	10.20	0.4016	70.0	118.0	45.0	12.00
R46310.3	–	10.30	0.4055	70.0	118.0	45.0	12.00
R46313/32	13/32	10.32	0.4063	70.0	118.0	45.0	12.00
R46310.4	–	10.40	0.4094	70.0	118.0	45.0	12.00
R46310.5	–	10.50	0.4134	70.0	118.0	45.0	12.00
R46310.6	–	10.60	0.4173	70.0	118.0	45.0	12.00
R46327/64	27/64	10.72	0.4219	70.0	118.0	45.0	12.00
R46310.8	–	10.80	0.4252	70.0	118.0	45.0	12.00
R46310.9	–	10.90	0.4291	70.0	118.0	45.0	12.00
R46311.0	–	11.00	0.4331	70.0	118.0	45.0	12.00
R4637/16	7/16	11.11	0.4375	70.0	118.0	45.0	12.00
R46311.2	–	11.20	0.4409	70.0	118.0	45.0	12.00
R46311.3	–	11.30	0.4449	70.0	118.0	45.0	12.00
R46311.4	–	11.40	0.4488	70.0	118.0	45.0	12.00
R46311.5	–	11.50	0.4528	70.0	118.0	45.0	12.00
R46329/64	29/64	11.51	0.4531	70.0	118.0	45.0	12.00
R46311.6	–	11.60	0.4567	70.0	118.0	45.0	12.00
R46311.8	–	11.80	0.4646	70.0	118.0	45.0	12.00
R46315/32	15/32	11.91	0.4688	70.0	118.0	45.0	12.00
R46312.0	–	12.00	0.4724	70.0	118.0	45.0	12.00
R46312.05	–	12.05	0.4744	76.0	124.0	45.0	14.00
R46312.2	–	12.20	0.4803	76.0	124.0	45.0	14.00
R46331/64	31/64	12.30	0.4844	76.0	124.0	45.0	14.00
R46312.5	–	12.50	0.4921	76.0	124.0	45.0	14.00
R46312.7	–	12.70	0.5000	76.0	124.0	45.0	14.00
R4631/2	1/2	12.70	0.5000	76.0	124.0	45.0	14.00
R46312.8	–	12.80	0.5039	76.0	124.0	45.0	14.00
R46313.0	–	13.00	0.5118	76.0	124.0	45.0	14.00
R46333/64	33/64	13.10	0.5156	76.0	124.0	45.0	14.00
R46313.3	–	13.30	0.5236	76.0	124.0	45.0	14.00
R46317/32	17/32	13.49	0.5313	76.0	124.0	45.0	14.00
R46313.5	–	13.50	0.5315	76.0	124.0	45.0	14.00
R46313.8	–	13.80	0.5433	76.0	124.0	45.0	14.00
R46335/64	35/64	13.89	0.5469	76.0	124.0	45.0	14.00
R46314.0	–	14.00	0.5512	76.0	124.0	45.0	14.00
R46314.25	–	14.25	0.5610	82.0	133.0	48.0	16.00
R4639/16	9/16	14.29	0.5625	82.0	133.0	48.0	16.00
R46314.5	–	14.50	0.5709	82.0	133.0	48.0	16.00
R46337/64	37/64	14.68	0.5781	82.0	133.0	48.0	16.00
R46314.8	–	14.80	0.5827	82.0	133.0	48.0	16.00
R46315.0	–	15.00	0.5906	82.0	133.0	48.0	16.00
R46319/32	19/32	15.08	0.5938	82.0	133.0	48.0	16.00
R46315.1	–	15.10	0.5945	82.0	133.0	48.0	16.00
R46315.3	–	15.30	0.6024	82.0	133.0	48.0	16.00
R46339/64	39/64	15.48	0.6094	82.0	133.0	48.0	16.00
R46315.5	–	15.50	0.6102	82.0	133.0	48.0	16.00
R46315.8	–	15.80	0.6220	82.0	133.0	48.0	16.00
R4635/8	5/8	15.88	0.6250	82.0	133.0	48.0	16.00
R46316.0	–	16.00	0.6299	82.0	133.0	48.0	16.00



TABULKA POSUVŮ PRO VRTÁNÍ

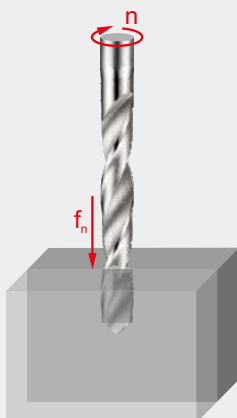

Posuv na otáčku (f_n v mm/ot)
V závislosti na pracovních podmínkách
může být nutné tyto hodnoty upravit
 $\pm 25\%$.

Jak pomoci této tabulky najít posuv na otáčku (f_n):

1. Vyhledejte svůj kód alfa na stránce produktu (například: 46J_nJⁿ je alfa kód).
2. V horním řádku tabulky najdete nejbližší průměr pro vaši řeznou aplikaci.
3. Vyhledejte svůj alfa kód v levém sloupci tabulky.
4. Průsečík (buňka) průměru a alfa kódu je posuv na otáčku (f_n).

		ø DC (mm)																		
		0.15	0.50	1.00	2.00	3.00	4.00	5.00	6.00	8.00	10.00	12.00	15.00	16.00	20.00	25.00	30.00	40.00	50.00	100.00
Posuvy	A	0.003	0.006	0.012	0.023	0.029	0.032	0.036	0.042	0.054	0.062	0.069	0.082	0.086	0.110	0.125	0.135	0.155	0.175	0.263
	B	0.004	0.007	0.014	0.028	0.037	0.041	0.046	0.053	0.067	0.080	0.090	0.103	0.108	0.135	0.153	0.165	0.188	0.208	0.312
	C	0.004	0.008	0.015	0.032	0.044	0.050	0.056	0.064	0.080	0.098	0.110	0.125	0.130	0.160	0.180	0.195	0.220	0.240	0.360
	D	0.004	0.008	0.016	0.038	0.053	0.060	0.068	0.078	0.098	0.119	0.130	0.149	0.155	0.188	0.210	0.228	0.253	0.275	0.413
	E	0.004	0.009	0.017	0.043	0.062	0.071	0.080	0.092	0.115	0.140	0.150	0.173	0.180	0.215	0.240	0.260	0.285	0.310	0.465
	F	0.005	0.009	0.018	0.050	0.073	0.084	0.095	0.109	0.138	0.165	0.178	0.202	0.210	0.248	0.275	0.295	0.320	0.343	0.515
	G	0.005	0.010	0.019	0.056	0.084	0.096	0.109	0.126	0.160	0.190	0.205	0.231	0.240	0.280	0.310	0.330	0.355	0.375	0.563
	H	0.005	0.010	0.020	0.066	0.102	0.116	0.130	0.150	0.190	0.228	0.243	0.271	0.280	0.320	0.355	0.375	0.398	0.418	0.627
	I	0.005	0.011	0.021	0.076	0.119	0.134	0.150	0.173	0.220	0.265	0.280	0.310	0.320	0.360	0.400	0.420	0.440	0.460	0.690
	J	0.006	0.012	0.024	0.084	0.135	0.152	0.170	0.197	0.250	0.298	0.315	0.349	0.360	0.405	0.445	0.465	0.485	0.503	0.755
	K	0.007	0.013	0.026	0.092	0.150	0.170	0.190	0.220	0.280	0.330	0.350	0.388	0.400	0.450	0.490	0.510	0.530	0.545	0.818
	L	0.007	0.014	0.028	0.101	0.165	0.186	0.208	0.240	0.305	0.360	0.385	0.419	0.430	0.485	0.525	0.545	0.568	0.588	0.882
	M	0.008	0.015	0.030	0.110	0.180	0.202	0.225	0.260	0.330	0.390	0.420	0.450	0.460	0.520	0.560	0.580	0.605	0.630	0.945
	N	0.008	0.016	0.032	0.119	0.195	0.218	0.242	0.280	0.355	0.420	0.455	0.481	0.490	0.555	0.595	0.615	0.642	0.672	1.008
	S	0.002	0.004	0.008	0.014	0.020	0.025	0.030	0.037	0.050	0.080	0.100	0.123	0.130	0.150	0.170	0.190	0.220	0.240	–
	T	0.004	0.008	0.015	0.028	0.040	0.050	0.060	0.070	0.090	0.110	0.130	0.160	0.170	0.190	0.210	0.230	0.260	0.275	–
	U	0.007	0.013	0.026	0.048	0.070	0.080	0.090	0.107	0.140	0.170	0.200	0.223	0.230	0.240	0.270	0.300	0.360	0.375	–
	V	0.010	0.019	0.038	0.069	0.100	0.115	0.130	0.153	0.200	0.250	0.280	0.310	0.320	0.340	0.400	0.440	0.510	0.530	–
	W	0.012	0.025	0.049	0.089	0.130	0.150	0.170	0.200	0.260	0.330	0.380	0.418	0.430	0.450	0.470	0.490	0.520	0.540	–
	X	0.014	0.028	0.056	0.103	0.150	0.180	0.210	0.250	0.330	0.420	0.480	0.533	0.550	0.580	–	–	–	–	–
Y	0.017	0.034	0.068	0.124	0.180	0.220	0.260	0.317	0.430	0.550	0.700	0.700	0.700	0.740	–	–	–	–	–	
Z	0.024	0.047	0.094	0.172	0.250	0.325	0.400	0.533	0.800	1.000	1.100	1.175	1.200	1.200	–	–	–	–	–	





HSS VRTÁKY



HSS VRTÁKY – NAVIGÁTOR PRO MATERIÁLY NÁSTROJE





Materiály nástroje

Rychlořezná ocel		Středně legovaná rychlořezná ocel, která má dobrou obrobiteľnosť a dobrý výkon. HSS vykazuje vlastnosti, jako je tvrdost, houževnatost a odolnost vůči opotřebení, díky nimž je atraktivní v široké škále aplikací například u vrtáků a závitníků.
Rychlořezná kobaltová ocel		Tato rychlořezná ocel obsahuje kobalt pro zvýšení tvrdosti za tepla. Složení HSCo poskytuje dobrou kombinaci houževnatosti a tvrdosti. Má dobrou obrobiteľnosť a dobrou odolnost vůči opotřebení, a proto je použitelná pro výrobu vrtáků, závitníků, výstružníků a fréz.





Karbidové materiály

Karbid a rychlořezná ocel		Kombinované karbidové a HSS materiály se spojují vysokoteplotní pájecí slitinou. Tato pájená kombinace nástrojových materiálů nabízí řeznou část ze slitutého karbidu, která poskytuje vysokou pevnost v tlaku, tvrdost a odolnost proti opotřebení připevněnou k HSS tělu, které poskytuje pevnost v ohybu a houževnatost.
----------------------------------	---	---

Povrchové úpravy

Broušený (bez povlaku)		Broušený povrch (povrch bez povlaku) zlepšuje tok třísek v měkkých nebo neželezných materiálech, plastech a kompozitech a udržuje ostré řezné hrany.
Kombinace broušeného a vaporizovaného povrchu		Kombinace broušeného a vaporizovaného povrchu může být účinná, protože poréznější povrch modrého oxidu působí na zadržování a natahování řezné kapaliny do otvoru, přičemž broušený povrch pomáhá při odvodu třísek. Těto kombinace je dosaženo broušením lesklého povrchu po temperování.
Vaporizování		Vaporizování poskytuje silně přilnavý povrch modrého oxidu, který přispívá k zadržování řezné kapaliny a zabraňuje tvorbě nárustku. Vaporizování lze použít na jakýkoli broušený nástroj, ale nejúčinnější je při použití na vrtáky a závitníky.
Povrchová úprava oxidem bronzu		Povrchová úprava oxidem bronzu vytváří na povrchu nástroje hladkou tenkou vrstvu oxidu bronzu. Podobně jako vaporizování pomáhá předcházet tvorbě nárustku a pomáhá při odvodu třísek. Povrchovou úpravu oxidem bronzu lze použít na jakýkoli broušený nástroj a na některé nástroje ho lze také použít v kombinaci s vaporizováním.

Povrchové povlaky

Broušený povrch a TiAIN (povlak špičky)		Nitrid titanu je zlatě zbarvený keramický povlak aplikovaný fyzikálním nanášením par (PVD). Vysoká tvrdost v kombinaci s nízkým třením zajišťuje podstatně delší životnost nástroje a/nebo lepší řezný výkon oproti nástrojům, které nebyly opatřeny povlakem.
Nitrid titanu (TiN)		Nitrid titanu je zlatě zbarvený keramický povlak aplikovaný fyzikálním nanášením par (PVD). Vysoká tvrdost v kombinaci s nízkým třením zajišťuje podstatně delší životnost nástroje a/nebo lepší řezný výkon oproti nástrojům, které nebyly opatřeny povlakem.
Povlaky nitridem titanu a hliníku (TiAIN, TiAIN-Top a X-CEED)	 	Povlak nitridem titanu a hliníku je vícevrstvý keramický povlak nanášený technologií PVD povlakování, která vykazuje vysokou houževnatost a oxidační stabilitu. Díky těmto vlastnostem je ideální pro vyšší rychlosti a posuvy a současně zvyšuje životnost nástroje. TiAIN se používá při vrtání, závitování a frézování a může být vhodný pro použití při obrábění bez chladicí kapaliny. Povlak TiAIN-Top je stejný jako povlak TiAIN, avšak s použitím další technologie po povlakování k vyhlazení nedokonalostí, zvýšení toku třísek a snížení tvorby nárustku.
Povlaky Alcrona (Alcrona-Top)		Skupina povlaků Alcrona (AlCrN) představuje povlaky z nitridu hliníku a chromu, které se většinou používají pro frézy. Dvě jedinečné vlastnosti těchto povlaků jsou vysoká tvrdost za tepla a vysoká odolnost vůči oxidaci. Při použití na nástrojích pro obrábění zahrnující velká mechanická a tepelná namáhání se tyto vlastnosti promítají do vynikající odolnosti vůči opotřebení. K dispozici je několik úrovní či konkrétních verzí těchto povlaků, které jsou specifické pro různé nástroje a aplikace.



Materiál nástroje (BMC)	HSS-E	HSS	HSS	HSS	HSS	HSS	HSS-E	HSS-E	HSS	HSS HM	HSS-E	HSS-E	HSS-E
Norma (BSG)	DORNER	DIN 1897	DIN 1897	DIN 1897	DIN 1897	DIN ANSI	DIN 1897	DIN 1897	DIN 1897	DIN 8037	DIN 1899	DIN ANSI	DIN ANSI
Hĺoubka vrtání (ULDR)	1×D	1.25×D	1×D	1.5×D	2.5×D	2.5×D	2.5×D	2.5×D	2.5×D	2.5×D	2.5×D	3×D	3×D
Úhel vrcholu	180°	120°	90°/120°	120°	135°	135°	130°	135°	130°	118°	118°	130°	130°
Povlak	Bronze	ST	Bright	ST	ST	TIN-Tip	Bronze	Bronze	TIN	Bright ST	Bright	Bright	Alcrona Top
Stopka													
Úhel šroubovice	λ20-35°	λ20-35°	λ20-35°	λ20-35°	λ20-35°	λ20-35°	λ20-35°	λ20-35°	λ32-40°	λ10-20°	λ20-35°	λ>35°	λ>35°
Směr chodu (otáček)	R	R	R	R	R	R	R	R	R	R	R	R	R
Chlazení (CSP)													
Kód produktové řady	A723	A119	A122	A123	A120	A022	A620	A117	A520	A124	A720	A920	A921
	6.00 - 8.00	3.30 - 5.10	6.00 - 20.00	3/32 - 1/4	0.50 - 25.00	0.50 - 16.00	2.50 - 13.00	1.00 - 13.00	3.00 - 13.00	3.00 - 16.00	0.15 - 1.40	1.00 - 20.00	2.50 - 16.00
	76	77	78	79	80	82	84	86	88	90	91	92	94
P	P1	■	■	■	■	■	■	■	■	■	■	■	■
	P2	■	■	■	■	■	■	■	■	■	■	■	■
	P3	■	■	■	■	■	■	■	■	■	■	■	■
	P4	■	■	■	■	■	■	■	■	■	■	■	■
M	M1		■	■	■	■	■	■	■	■	■	■	■
	M2		■	■	■	■	■	■	■	■	■	■	■
	M3		■	■	■	■	■	■	■	■	■	■	■
	M4		■	■	■	■	■	■	■	■	■	■	■
K	K1			■	■	■	■	■	■	■	■	■	■
	K2			■	■	■	■	■	■	■	■	■	■
	K3			■	■	■	■	■	■	■	■	■	■
	K4			■	■	■	■	■	■	■	■	■	■
	K5			■	■	■	■	■	■	■	■	■	■
N	N1		■	■	■	■	■	■	■	■	■	■	■
	N2		■	■	■	■	■	■	■	■	■	■	■
	N3		■	■	■	■	■	■	■	■	■	■	■
	N4		■	■	■	■	■	■	■	■	■	■	■
	N5												
S	S1		■	■	■	■	■	■	■	■	■	■	■
	S2		■	■	■	■	■	■	■	■	■	■	■
	S3		■	■	■	■	■	■	■	■	■	■	■
	S4		■	■	■	■	■	■	■	■	■	■	■
H	H1												
	H2												
	H3												
	H4												

■ Hlavní použití ■ Podmíněné použití



	HSS	HSS	HSS	HSS	HSS	HSS-E	HSS-E	HSS HM	HSS	HSS-E	HSS-E	HSS-E	HSS	HSS	HSS	
	DIN 338	DIN 338	DIN 338	DIN 338	DIN 338	DIN 338	DIN 338	DIN 338	DIN 338	DIN 338	DIN 338	DIN ANSI	DIN ANSI	DIN ANSI	DIN ANSI	DIN ANSI
	4xD	4xD	4xD	4xD	4xD	4xD	4xD	4xD	4xD	4xD	5xD	6xD	6xD	4xD	4xD	4xD
	118°	118°	118°	118°	135°	130°	135°	118°	130°	130°	130°	130°	130°	118°	135°	118°
	TiN-Tip	TiN-Tip	ST	ST	ST	Bright	Bronze	Bright ST	TiN	TiAlN Top	Bright	Alcrona Top	ST	Bright	Bright	Bright
	λ>20-35°	λ>20-35°	λ>20-35°	λ>20-35°	λ>35°	VA	λ>20-35°	λ>20-35°	λ>32-40°	λ>35°	λ>35°	λ>35°	λ>20-35°	λ>20-35°	λ>20-35°	λ>20-35°
	R	R	R	L	R	R	R	R	R	R	R	R	R	R	R	R
	A002	A002S	A100	A101	A108	A147	A777	A160	ADX	ADX	PFX	PFX	A170	A243	A244	
	1.00 - 16.00	2.00 - 13.00	0.20 - 20.00	1.00 - 12.00	1.00 - 16.00	0.30 - 15.0	0.30 - 16.00	4.00 - 16.00	3.00 - 14.00	5.00 - 20.00	1.00 - 20.00	1.50 - 16.00	13.00 - 1.1/2	3/32 - 1/4	1/8 - 1/4	
	96	98	99	103	104	106	108	110	111	113	114	116	118	120	121	
P1	■	■	■	■	■	■	■	■	■	■	■	■	■	■	■	■
P2	■	■	■	■	■	■	■	■	■	■	■	■	■	■	■	■
P3	■	■	■	■	■	■	■	■	■	■	■	■	■	■	■	■
P4	■	■	■	■	■	■	■	■	■	■	■	■	■	■	■	■
M1	■	■	■	■	■	■	■	■	■	■	■	■	■	■	■	■
M2	■	■	■	■	■	■	■	■	■	■	■	■	■	■	■	■
M3	■	■	■	■	■	■	■	■	■	■	■	■	■	■	■	■
M4	■	■	■	■	■	■	■	■	■	■	■	■	■	■	■	■
K1	■	■	■	■	■	■	■	■	■	■	■	■	■	■	■	■
K2	■	■	■	■	■	■	■	■	■	■	■	■	■	■	■	■
K3	■	■	■	■	■	■	■	■	■	■	■	■	■	■	■	■
K4	■	■	■	■	■	■	■	■	■	■	■	■	■	■	■	■
K5	■	■	■	■	■	■	■	■	■	■	■	■	■	■	■	■
N1	■	■	■	■	■	■	■	■	■	■	■	■	■	■	■	■
N2	■	■	■	■	■	■	■	■	■	■	■	■	■	■	■	■
N3	■	■	■	■	■	■	■	■	■	■	■	■	■	■	■	■
N4	■	■	■	■	■	■	■	■	■	■	■	■	■	■	■	■
N5	■	■	■	■	■	■	■	■	■	■	■	■	■	■	■	■
S1	■	■	■	■	■	■	■	■	■	■	■	■	■	■	■	■
S2	■	■	■	■	■	■	■	■	■	■	■	■	■	■	■	■
S3	■	■	■	■	■	■	■	■	■	■	■	■	■	■	■	■
S4	■	■	■	■	■	■	■	■	■	■	■	■	■	■	■	■
H1																
H2																
H3																
H4																

■ Hlavní použití □ Podmíněné použití



Materiál nástroje (BMC)	HSS	HSS-E	HSS-E	HSS	HSS-E	HSS-E	HSS-E	HSS	HSS	HSS-E	HSS HM	HSS	HSS
Norma (BSG)	DIN 340	DIN ANSI	DIN ANSI	BS 328	DIN 1869-1	DIN 1869-2	DIN 1869-3	DIN 345	DIN 345	DIN 345	DIN 345	DIN 341	DIN 1870(1)
Hĺoubka vrtání (ULDR)	6×D	10×D	10×D	10×D	15×D	20×D	25×D	4×D	4×D	4×D	4×D	6×D	10×D
Úhel vrcholu	118°	130°	130°	118°	130°	130°	130°	118°	118°	118°	118°	118°	118°
Povlak	ST	Bright	Alcrona Top	ST	Bright	Bright	Bright	ST	TiN	Bronze	Bright ST	ST	ST
Stopka													
Úhel šroubovice	λ>20-35°	λ>35°	λ>35°	λ>20-35°	λ>35°	λ>35°	λ>35°	λ>20-35°	λ>20-35°	λ>20-35°	λ>20-35°	λ>20-35°	λ>20-35°
Směr chodu (otáček)	R	R	R	R	R	R	R	R	R	R	R	R	R
Chlazení (CSP)													
Kód produktové řady	A110	A940	A941	A125	A976	A977	A978	A130	A530	A730	A166	A350	A345
	0.50 - 1"	1.00 - 20.00	1.00 - 16.00	1.40 - 1"	1.50 - 14.00	1.50 - 14.00	3.00 - 10.00	3.00 - 50.80	8.50 - 40.00	10.00 - 32.00	10.00 - 33.00	5.00 - 50.00	8.00 - 50.00
	122	124	126	128	130	132	133	134	140	141	143	144	146
P	P1	■	■	■	■	■	■	■	■	■	■	■	■
	P2	■	■	■	■	■	■	■	■	■	■	■	■
	P3	■	■	■	■	■	■	■	■	■	■	■	■
	P4	■	■	■	■	■	■	■	■	■	■	■	■
M	M1	■	■	■	■	■	■	■	■	■	■	■	■
	M2	■	■	■	■	■	■	■	■	■	■	■	■
	M3	■	■	■	■	■	■	■	■	■	■	■	■
	M4	■	■	■	■	■	■	■	■	■	■	■	■
K	K1	■	■	■	■	■	■	■	■	■	■	■	■
	K2	■	■	■	■	■	■	■	■	■	■	■	■
	K3	■	■	■	■	■	■	■	■	■	■	■	■
	K4	■	■	■	■	■	■	■	■	■	■	■	■
	K5	■	■	■	■	■	■	■	■	■	■	■	■
N	N1	■	■	■	■	■	■	■	■	■	■	■	■
	N2	■	■	■	■	■	■	■	■	■	■	■	■
	N3	■	■	■	■	■	■	■	■	■	■	■	■
	N4	■	■	■	■	■	■	■	■	■	■	■	■
	N5	■	■	■	■	■	■	■	■	■	■	■	■
S	S1	■	■	■	■	■	■	■	■	■	■	■	■
	S2	■	■	■	■	■	■	■	■	■	■	■	■
	S3	■	■	■	■	■	■	■	■	■	■	■	■
	S4	■	■	■	■	■	■	■	■	■	■	■	■
H	H1												
	H2												
	H3												
	H4												

■ Hlavní použití ■ Podmíněné použití



	HSS	HSS	HSS	HSS	HSS	HSS	HSS	HSS	HSS	HSS-E	HSS-E	HSS	HSS	HSS	HSS-E
	DIN 1870(1)	DIN 1870(2)	DIN 8374	DIN 8376	DIN 8377	DORNER	DORNER	DIN 333A	DIN 333A	DIN 333A	DIN 333A	DIN 333R	DORNER	BS 328	DIN 333A
	15xD	20xD	4xD	4xD	4xD	2.5xD	2.5xD	1xD	1xD	1xD	1xD	1xD	1xD	1xD	1xD
	A951	A952	A400	A402	A405	A412	A413	A200	A205	A206	A266	A210	A201	A225	A237
	10.00 - 30.00	8.00 - 40.00	M3 - M10	M3 - M10	M6 - M18	M3 - M10	M3 - M10	0.50 - 12.50	1.00 - 5.00	1.00 - 5.00	1.00 - 5.00	0.50 - 10.00	0.63 - 6.00	3/64 - 5/16	1.60 - 10.00
	148	149	150	151	152	153	154	155	156	157	158	159	160	161	162
P1	■	■	■	■	■	■	■	■	■	■	■	■	■	■	■
P2	■	■	■	■	■	■	■	■	■	■	■	■	■	■	■
P3	■	■	■	■	■	■	■	■	■	■	■	■	■	■	■
P4	■	■	■	■	■	■	■	■	■	■	■	■	■	■	■
M1	■	■	■	■	■	■	■	■	■	■	■	■	■	■	■
M2	■	■	■	■	■	■	■	■	■	■	■	■	■	■	■
M3	■	■	■	■	■	■	■	■	■	■	■	■	■	■	■
M4	■	■	■	■	■	■	■	■	■	■	■	■	■	■	■
K1	■	■	■	■	■	■	■	■	■	■	■	■	■	■	■
K2	■	■	■	■	■	■	■	■	■	■	■	■	■	■	■
K3	■	■	■	■	■	■	■	■	■	■	■	■	■	■	■
K4	■	■	■	■	■	■	■	■	■	■	■	■	■	■	■
K5	■	■	■	■	■	■	■	■	■	■	■	■	■	■	■
N1	■	■	■	■	■	■	■	■	■	■	■	■	■	■	■
N2	■	■	■	■	■	■	■	■	■	■	■	■	■	■	■
N3	■	■	■	■	■	■	■	■	■	■	■	■	■	■	■
N4	■	■	■	■	■	■	■	■	■	■	■	■	■	■	■
N5															
S1	■	■	■	■	■	■	■	■	■	■	■	■	■	■	■
S2	■	■	■	■	■	■	■	■	■	■	■	■	■	■	■
S3	■	■	■	■	■	■	■	■	■	■	■	■	■	■	■
S4	■	■	■	■	■	■	■	■	■	■	■	■	■	■	■
H1															
H2															
H3															
H4															



Materiál nástroje (BMC)	HSS-E	HSS-E	HSS	HSS	HSS	HSS	HSS
Norma (BSG)	DIN 333R	DORMER	DIN ANSI	DIN 338	DIN 338	DIN 338	DIN 338
Hloubka vrtání (ULDR)	1xD	1xD	2.5xD	4xD	4xD	4xD	4xD
Úhel vrcholu	R	60°	135°	118°	118°	118°	118°
Povlak	Bright	Bright	TiN-Tip	TiN-Tip	TiN-Tip	TiN-Tip	TiN-Tip
Stopka	H						
Úhel šroubovice			λ 20-35°	λ 20-35°	λ 20-35°	λ 20-35°	λ 20-35°
Směr chodu (otáček)	R	R	R	R	R	R	R
Chlazení (CSP)							
Kód produktové řady	A238	A242	A088	A095	A087	A094	A089
	1.60 - 8.00	1.00 - 5.00	Set	Set	Set	Set	Set
	163	164	165	165	166	166	167
P	P1	■	■				
	P2	■	■				
	P3	■	■				
	P4	▣	▣				
M	M1	▣	▣				
	M2	▣	▣				
	M3	▣	▣				
	M4	▣	▣				
K	K1	■	■				
	K2	▣	▣				
	K3	▣	▣				
	K4	▣	▣				
	K5	▣	▣				
N	N1	▣	▣				
	N2	▣	▣				
	N3	▣	▣				
	N4	▣	▣				
	N5						
S	S1	▣	▣				
	S2	▣	▣				
	S3	▣	▣				
	S4	▣	▣				
H	H1						
	H2						
	H3						
	H4						

■ Hlavní použití ▣ Podmíněné použití



A099	A099	A199	A080	A190
-------------	-------------	-------------	-------------	-------------

Set	Drillboy	Set	Set	Set
-----	----------	-----	-----	-----

168	168	169	169	170
-----	-----	-----	-----	-----

P1				
P2				
P3				
P4				
M1				
M2				
M3				
M4				
K1				
K2				
K3				
K4				
K5				
N1				
N2				
N3				
N4				
N5				
S1				
S2				
S3				
S4				
H1				
H2				
H3				
H4				



Materiál nástroje (BMC)		HSS	HSS	HSS	HSS-E			
Norma (BSG)		DIN 338	DIN 338	DIN 338	DIN 338			
Hloubka vrtání (ULDR)		4xD	4xD	4xD	4xD			
Úhel vrcholu		118°	118°	135°	135°	60°		
Povlak		ST	ST	ST	Bronze			
Stopka								
Úhel šroubovice		λ 20-35°	λ 20-35°	λ >35°	λ 20-35°			
Směr chodu (otáček)		R	R	R	R			
Chlazení (CSP)								
Kód produktové řady		A191	A191	A188	A295	A296	M150	M151
		Set	Set	Set	Set	Set		
		171	171	172	172	173	173	174
P	P1							
	P2							
	P3							
	P4							
M	M1							
	M2							
	M3							
	M4							
K	K1							
	K2							
	K3							
	K4							
	K5							
N	N1							
	N2							
	N3							
	N4							
	N5							
S	S1							
	S2							
	S3							
	S4							
H	H1							
	H2							
	H3							
	H4							

■ Hlavní použití ▣ Podmíněné použití



A723



HSS-E (5 % kobaltu) Vrták na bodové svary, Povrchová úprava Bronz

Vrták se speciální geometrií určený pro odvrtání bodových svarů, běžně používaný pro opravy v autoopravnách. Krátká drážka pro zvýšení tuhosti a snížení vibrací při ručních operacích. Bronzový povrch je tenká oxidační vrstva použitá na HSS-E vrtácích s obsahem kobaltu.

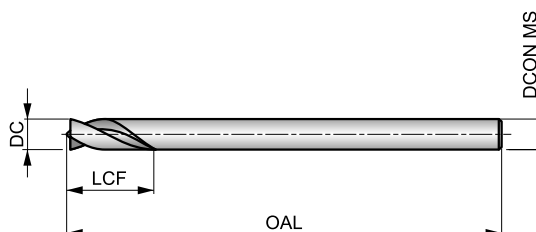

HSS-E		1xD
Bronze		λ 20-35°
	DC h8	

Skupiny obráběných materiálů, startovní řezná rychlost (Vc m/min) a kód posuvu. Tabulku s posuvem na otáčku naleznete od strany 175.

P1.1 ■ 33 D	P1.2 ■ 37 D	P1.3 ■ 38 D	P2.1 ■ 28 D	P2.2 ■ 25 C	P3.1 ■ 20 C	P3.2 ■ 20 C	P4.1 ■ 20 C
-----------------------	-----------------------	-----------------------	-----------------------	-----------------------	-----------------------	-----------------------	-----------------------

Produkt	DC	DC	LCF	OAL	DCON MS
	(mm)	(inch)			
A7236.0X66	6.00	0.2362	18.0	66.0	6.00
A7236.0X93	6.00	0.2362	18.0	93.0	6.00
A7238.0X79	8.00	0.3150	24.0	79.0	8.00
A7238.0X117	8.00	0.3150	24.0	117.0	8.00



A119



HSS Dvoustranný navrtávák, Parní temperace povrchu

Krátký oboustranný vrták s využitím obou konců dává dvojnásobnou životnost. Vrcholový úhel 120° napomáhá vystředění. Vhodný pro širokou oblast obráběných materiálů. Parní temperace povrchu zadržuje řeznou kapalinu a zabráňuje nalepování třísek.

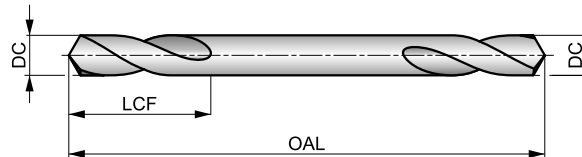

HSS	DIN 1897	1.25xD
120°	ST	
20-35°	R	DC h8

Skupiny obráběných materiálů, startovní řezná rychlost (Vc m/min) a kód posuvu. Tabulku s posuvem na otáčku naleznete od strany 175.

P1.1 ■ 31 C	P1.2 ■ 34 C	P1.3 ■ 35 C	P2.1 ■ 26 C	P2.2 ■ 23 C	P2.3 ■ 20 C	P3.1 ■ 12 C	P3.2 ■ 9 C	P3.3 ■ 8 C	P4.1 ■ 7 C	P4.2 ■ 6 C	P4.3 ■ 5 A	M1.1 ■ 21 A	M1.2 ■ 17 A
M2.1 ■ 18 A	M2.2 ■ 15 A	M3.1 ■ 8 C	M3.2 ■ 7 C	M3.3 ■ 6 C	M4.1 ■ 10 A	N1.1 ■ 33 C	N1.2 ■ 25 C	N1.3 ■ 17 C	N2.1 ■ 46 C	N2.2 ■ 42 C	N2.3 ■ 30 C	N3.1 ■ 56 C	N3.2 ■ 33 C
N3.3 ■ 17 A	N4.1 ■ 30 I	N4.2 ■ 35 C	S1.1 ■ 27 A	S1.2 ■ 12 A	S1.3 ■ 7 A	S2.1 ■ 5 C	S2.2 ■ 4 C	S3.1 ■ 4 C	S3.2 ■ 3 C	S4.1 ■ 3 C	S4.2 ■ 2 C		

Vrták do plechu.

Produkt	DC	DC	LCF	OAL	DCON MS
	(mm)	(inch)	(mm)	(mm)	(mm)
A1193.3	3.30	0.1299	11.0	49.0	3.30
A1193.6	3.60	0.1417	12.0	52.0	3.60
A1194.1	4.10	0.1614	14.0	55.0	4.10
A1194.2	4.20	0.1654	14.0	55.0	4.20
A1194.9	4.90	0.1929	17.0	62.0	4.90
A1195.1	5.10	0.2008	17.0	62.0	5.10



A122



HSS Navrtávák, Leštěný

Určený pro předvrtání a přesné vedení při následném vrtání otvorů. Dostupné jsou dvě varianty - s vrcholovým úhlem 90° nebo 120°. Navrtávák je leštěný. Vhodný pro vrtání široké oblasti materiálů.

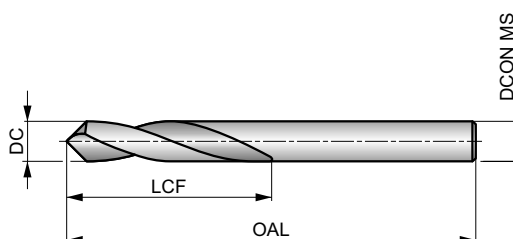

HSS	DIN 1897	1xD
90°/120°	Bright	
λ 20-35°	R	DC h8

Skupiny obráběných materiálů, startovní řezná rychlost (Vc m/min) a kód posuvu. Tabulku s posuvem na otáčku naleznete od strany 175.

P1.1 ■ 36 E	P1.2 ■ 40 E	P1.3 ■ 41 E	P2.1 ■ 31 E	P2.2 ■ 27 C	P2.3 ■ 24 C	P3.1 ■ 21 C	P3.2 ■ 17 C	P3.3 ■ 14 C	P4.1 ■ 12 C	P4.2 ■ 10 C	P4.3 ■ 9 B	M1.1 ■ 22 C	M1.2 ■ 19 C
M2.1 ■ 20 C	M2.2 ■ 16 C	M3.1 ■ 10 D	M3.2 ■ 9 D	M3.3 ■ 8 D	M4.1 ■ 10 B	K1.1 ■ 32 E	K1.2 ■ 24 C	K1.3 ■ 18 C	K2.1 ■ 25 C	K2.2 ■ 20 C	K2.3 ■ 16 B	K3.1 ■ 22 C	K3.2 ■ 17 C
K3.3 ■ 13 B	K4.1 ■ 20 C	K4.2 ■ 15 C	K4.3 ■ 11 B	K4.4 ■ 10 B	K4.5 ■ 8 B	K5.1 ■ 23 C	K5.2 ■ 17 C	K5.3 ■ 13 B	N1.1 ■ 33 E	N1.2 ■ 25 E	N1.3 ■ 17 E	N2.1 ■ 46 D	N2.2 ■ 42 D
N2.3 ■ 30 D	N3.1 ■ 56 D	N3.2 ■ 33 E	N3.3 ■ 17 D	N4.1 ■ 30 F	N4.2 ■ 35 E	N4.3 ■ 17 D	S1.1 ■ 27 C	S1.2 ■ 12 B	S1.3 ■ 7 A	S2.1 ■ 11 C	S2.2 ■ 6 A	S3.1 ■ 8 C	S3.2 ■ 4 A
S4.1 ■ 6 C	S4.2 ■ 3 A												

Produkt	DC	DC	LCF	OAL	DCON MS
	(mm)	(inch)			
A1226.0X90	6.00	0.2362	30.0	66.0	6.00
A1226.0X120	6.00	0.2362	30.0	66.0	6.00
A1228.0X90	8.00	0.3150	33.0	79.0	8.00
A1228.0X120	8.00	0.3150	33.0	79.0	8.00
A12210.0X90	10.00	0.3937	35.0	89.0	10.00
A12210.0X120	10.00	0.3937	35.0	89.0	10.00
A12212.0X90	12.00	0.4724	40.0	102.0	12.00
A12212.0X120	12.00	0.4724	40.0	102.0	12.00
A12216.0X90	16.00	0.6299	40.0	115.0	16.00
A12216.0X120	16.00	0.6299	40.0	115.0	16.00
A12220.0X90	20.00	0.7874	55.0	131.0	20.00
A12220.0X120	20.00	0.7874	55.0	131.0	20.00



A123



HSS Navrtávák pro vrtání plechů, Parní temperace povrchu

Speciálně konstruovaný pro vrtání tenkých dílů a plechů. Vrcholový úhel 120°. Parní temperace povrchu brání nalepování třísek na břit a napomáhá dosažení lepšího povrchu a přesnějšího otvoru. Vhodný pro širokou oblast obráběných materiálů.

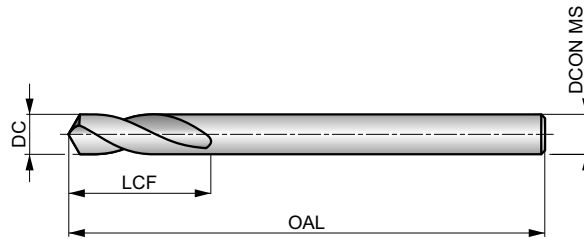

HSS	DIN 1897	1.5×D
120°	ST	
λ 20-35°	R	DC h8

Skupiny obráběných materiálů, startovní řezná rychlost (Vc m/min) a kód posuvu. Tabulku s posuvem na otáčku naleznete od strany 175.

P1.1 ■ 36 E	P1.2 ■ 40 E	P1.3 ■ 41 E	P2.1 ■ 31 E	P2.2 ■ 27 C	P2.3 ■ 24 C	P3.1 ■ 21 C	P3.2 ■ 17 C	P3.3 ■ 14 C	P4.1 ■ 12 C	P4.2 ■ 10 C	P4.3 ■ 9 B	M1.1 ■ 22 C	M1.2 ■ 19 C
M2.1 ■ 20 C	M2.2 ■ 16 C	M3.1 ■ 10 D	M3.2 ■ 9 D	M3.3 ■ 8 D	M4.1 ■ 10 B	N1.1 ■ 33 E	N1.2 ■ 25 E	N1.3 ■ 17 E	N2.1 ■ 46 D	N2.2 ■ 42 D	N2.3 ■ 30 D	N3.1 ■ 56 D	N3.2 ■ 33 E
N3.3 ■ 17 D	N4.1 ■ 30 F	N4.2 ■ 35 E	N4.3 ■ 17 D	S1.1 ■ 27 C	S1.2 ■ 12 B	S1.3 ■ 7 A	S2.1 ■ 11 C	S2.2 ■ 6 A	S3.1 ■ 8 C	S3.2 ■ 4 A	S4.1 ■ 6 C	S4.2 ■ 3 A	

Vrták do plechu.

Produkt	DC	DC	DC	LCF	OAL	DCON MS
	(inch)	(mm)	(inch)			
A1233/32S	3/32	2.38	0.0937	14.0	43.0	2.38
A1232.5S	–	2.50	0.0984	14.0	43.0	2.50
A1233.0S	–	3.00	0.1181	16.0	46.0	3.00
A1231/8S	1/8	3.18	0.1252	18.0	49.0	3.18
A1233.2S	–	3.20	0.1260	18.0	49.0	3.20
A1233.3S	–	3.30	0.1299	18.0	49.0	3.30
A1233.5S	–	3.50	0.1378	18.0	52.0	3.50
A1233.7S	–	3.70	0.1457	18.0	52.0	3.70
A1235/32S	5/32	3.97	0.1563	18.0	55.0	3.97
A1234.0S	–	4.00	0.1575	18.0	55.0	4.00
A1234.1S	–	4.10	0.1614	18.0	55.0	4.10
A1234.2S	–	4.20	0.1654	18.0	55.0	4.20
A1234.5S	–	4.50	0.1772	18.0	58.0	4.50
A1233/16S	3/16	4.76	0.1875	18.0	62.0	4.76
A1234.8S	–	4.80	0.1890	18.0	62.0	4.80
A1234.9S	–	4.90	0.1929	18.0	62.0	4.90
A1235.0S	–	5.00	0.1969	18.0	62.0	5.00
A1235.5S	–	5.50	0.2165	18.0	66.0	5.50
A1237/32S	7/32	5.56	0.2188	18.0	66.0	5.56
A1236.0S	–	6.00	0.2362	18.0	66.0	6.00
A1231/4S	1/4	6.35	0.2500	19.0	70.0	6.35



A120



HSS Navrtvák, Parní temperace povrchu

Univerzální vrták s parní temperací povrchu. Vrcholový úhel 135° snižuje řezné síly a brání uhybání vrtáku po povrchu obrobku. Parní temperace povrchu zadržuje řeznou kapalinu a zabraňuje nalepování třísek na břit. Vhodný pro ruční operace a širokou oblast obráběných materiálů.

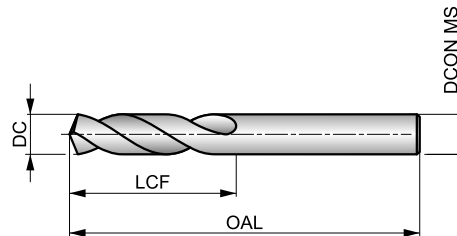

HSS	DIN 1897	2.5×D
135°	ST	
λ 20-35°	R	DC h8

Skupiny obráběných materiálů, startovní řezná rychlost (Vc m/min) a kód posuvu. Tabulku s posuvem na otáčku naleznete od strany 175.

P1.1 ■ 36 J	P1.2 ■ 40 J	P1.3 ■ 41 J	P2.1 ■ 31 J	P2.2 ■ 27 G	P2.3 ■ 24 F	P3.1 ■ 21 G	P3.2 ■ 17 G	P3.3 ■ 14 F	P4.1 ■ 12 G	P4.2 ■ 10 F	P4.3 ■ 9 E	M1.1 ■ 22 F	M1.2 ■ 19 F
M2.1 ■ 20 F	M2.2 ■ 16 F	M3.1 ■ 10 H	M3.2 ■ 9 H	M3.3 ■ 8 H	M4.1 ■ 10 D	K1.1 ■ 32 J	K1.2 ■ 24 G	K1.3 ■ 18 G	K2.1 ■ 25 F	K2.2 ■ 20 F	K2.3 ■ 16 F	K3.1 ■ 22 F	K3.2 ■ 17 F
K3.3 ■ 13 F	K4.1 ■ 20 F	K4.2 ■ 15 F	K4.3 ■ 11 F	K4.4 ■ 10 F	K4.5 ■ 8 F	K5.1 ■ 23 F	K5.2 ■ 17 F	K5.3 ■ 13 F	N1.1 ■ 33 K	N1.2 ■ 25 K	N1.3 ■ 17 J	N2.1 ■ 46 I	N2.2 ■ 42 I
N2.3 ■ 30 I	N3.1 ■ 64 I	N3.2 ■ 38 J	N3.3 ■ 19 H	N4.1 ■ 30 K	N4.2 ■ 35 I	N4.3 ■ 17 G	S1.1 ■ 27 G	S1.2 ■ 16 E	S1.3 ■ 8 C	S2.1 ■ 11 F	S2.2 ■ 6 B	S3.1 ■ 8 F	S3.2 ■ 4 B
S4.1 ■ 6 F	S4.2 ■ 3 B												

DC ≤ 1mm - leštěný; 2,9mm => DC ≥ 13,0mm - 118° úhel špičky.

Produkt	DC (inch)	DC (mm)	DC (inch)	LCF (mm)	OAL (mm)	DCON MS (mm)
A120.5	-	0.50	0.0197	3.0	20.0	0.50
A120.6	-	0.60	0.0236	3.5	21.0	0.60
A120.7	-	0.70	0.0276	4.5	23.0	0.70
A1201/32	1/32	0.79	0.0313	5.0	24.0	0.79
A120.8	-	0.80	0.0315	5.0	24.0	0.80
A120.9	-	0.90	0.0354	5.5	25.0	0.90
A1201.0	-	1.00	0.0394	6.0	26.0	1.00
A1201.1	-	1.10	0.0433	7.0	28.0	1.10
A1203/64	3/64	1.19	0.0469	8.0	30.0	1.19
A1201.2	-	1.20	0.0472	8.0	30.0	1.20
A1201.3	-	1.30	0.0512	8.0	30.0	1.30
A1201.4	-	1.40	0.0551	9.0	32.0	1.40
A1201.5	-	1.50	0.0591	9.0	32.0	1.50
A1201/16	1/16	1.59	0.0625	10.0	34.0	1.59
A1201.6	-	1.60	0.0630	10.0	34.0	1.60
A1201.7	-	1.70	0.0669	10.0	34.0	1.70
A1201.8	-	1.80	0.0709	11.0	36.0	1.80
A1201.9	-	1.90	0.0748	11.0	36.0	1.90
A1205/64	5/64	1.98	0.0781	12.0	38.0	1.98
A1202.0	-	2.00	0.0787	12.0	38.0	2.00
A1202.1	-	2.10	0.0827	12.0	38.0	2.10
A1202.2	-	2.20	0.0866	13.0	40.0	2.20
A1202.25	-	2.25	0.0886	13.0	40.0	2.25

Produkt	DC (inch)	DC (mm)	DC (inch)	LCF (mm)	OAL (mm)	DCON MS (mm)
A1202.3	-	2.30	0.0906	13.0	40.0	2.30
A1203/32	3/32	2.38	0.0938	14.0	43.0	2.38
A1202.4	-	2.40	0.0945	14.0	43.0	2.40
A1202.5	-	2.50	0.0984	14.0	43.0	2.50
A1202.6	-	2.60	0.1024	14.0	43.0	2.60
A1202.65	-	2.65	0.1043	14.0	43.0	2.65
A1202.7	-	2.70	0.1063	16.0	46.0	2.70
A1207/64	7/64	2.78	0.1094	16.0	46.0	2.78
A1202.8	-	2.80	0.1102	16.0	46.0	2.80
A1202.9	-	2.90	0.1142	16.0	46.0	2.90
A1203.0	-	3.00	0.1181	16.0	46.0	3.00
A1203.1	-	3.10	0.1220	18.0	49.0	3.10
A1201/8	1/8	3.18	0.1252	18.0	49.0	3.18
A1203.2	-	3.20	0.1260	18.0	49.0	3.20
A1203.25	-	3.25	0.1280	18.0	49.0	3.25
A1203.3	-	3.30	0.1299	18.0	49.0	3.30
A1203.4	-	3.40	0.1339	20.0	52.0	3.40
A1203.5	-	3.50	0.1378	20.0	52.0	3.50
A1209/64	9/64	3.57	0.1406	20.0	52.0	3.57
A1203.6	-	3.60	0.1417	20.0	52.0	3.60
A1203.7	-	3.70	0.1457	20.0	52.0	3.70
A1203.8	-	3.80	0.1496	22.0	55.0	3.80
A1203.9	-	3.90	0.1535	22.0	55.0	3.90



Produkt	DC	DC	DC	LCF	OAL	D CON MS
	(inch)	(mm)	(inch)	(mm)	(mm)	(mm)
A1205/32	5/32	3.97	0.1563	22.0	55.0	3.97
A1204.0	–	4.00	0.1575	22.0	55.0	4.00
A1204.1	–	4.10	0.1614	22.0	55.0	4.10
A1204.2	–	4.20	0.1654	22.0	55.0	4.20
A1204.3	–	4.30	0.1693	24.0	58.0	4.30
A12011/64	11/64	4.37	0.1719	24.0	58.0	4.37
A1204.4	–	4.40	0.1732	24.0	58.0	4.40
A1204.5	–	4.50	0.1772	24.0	58.0	4.50
A1204.6	–	4.60	0.1811	24.0	58.0	4.60
A1204.7	–	4.70	0.1850	24.0	58.0	4.70
A1203/16	3/16	4.76	0.1875	26.0	62.0	4.76
A1204.8	–	4.80	0.1890	26.0	62.0	4.80
A1204.9	–	4.90	0.1929	26.0	62.0	4.90
A1205.0	–	5.00	0.1969	26.0	62.0	5.00
A1205.1	–	5.10	0.2008	26.0	62.0	5.10
A12013/64	13/64	5.16	0.2031	26.0	62.0	5.16
A1205.2	–	5.20	0.2047	26.0	62.0	5.20
A1205.3	–	5.30	0.2087	26.0	62.0	5.30
A1205.4	–	5.40	0.2126	28.0	66.0	5.40
A1205.5	–	5.50	0.2165	28.0	66.0	5.50
A1207/32	7/32	5.56	0.2188	28.0	66.0	5.56
A1205.6	–	5.60	0.2205	28.0	66.0	5.60
A1205.7	–	5.70	0.2244	28.0	66.0	5.70
A1205.8	–	5.80	0.2283	28.0	66.0	5.80
A1205.9	–	5.90	0.2323	28.0	66.0	5.90
A12015/64	15/64	5.95	0.2344	28.0	66.0	5.95
A1206.0	–	6.00	0.2362	28.0	66.0	6.00
A1206.1	–	6.10	0.2402	31.0	70.0	6.10
A1206.2	–	6.20	0.2441	31.0	70.0	6.20
A1206.3	–	6.30	0.2480	31.0	70.0	6.30
A1201/4	1/4	6.35	0.2500	31.0	70.0	6.35
A1206.4	–	6.40	0.2520	31.0	70.0	6.40
A1206.5	–	6.50	0.2559	31.0	70.0	6.50
A1206.6	–	6.60	0.2598	31.0	70.0	6.60
A1206.7	–	6.70	0.2638	31.0	70.0	6.70
A1206.8	–	6.80	0.2677	34.0	74.0	6.80
A1206.9	–	6.90	0.2717	34.0	74.0	6.90
A1207.0	–	7.00	0.2756	34.0	74.0	7.00
A1207.1	–	7.10	0.2795	34.0	74.0	7.10
A1209/32	9/32	7.14	0.2813	34.0	74.0	7.14
A1207.2	–	7.20	0.2835	34.0	74.0	7.20
A1207.3	–	7.30	0.2874	34.0	74.0	7.30
A1207.4	–	7.40	0.2913	34.0	74.0	7.40
A1207.5	–	7.50	0.2953	34.0	74.0	7.50
A1207.6	–	7.60	0.2992	37.0	79.0	7.60
A1207.7	–	7.70	0.3031	37.0	79.0	7.70
A1207.8	–	7.80	0.3071	37.0	79.0	7.80
A1207.9	–	7.90	0.3110	37.0	79.0	7.90
A1205/16	5/16	7.94	0.3125	37.0	79.0	7.94
A1208.0	–	8.00	0.3150	37.0	79.0	8.00
A1208.1	–	8.10	0.3189	37.0	79.0	8.10
A1208.2	–	8.20	0.3228	37.0	79.0	8.20
A1208.3	–	8.30	0.3268	37.0	79.0	8.30
A1208.4	–	8.40	0.3307	37.0	79.0	8.40
A1208.5	–	8.50	0.3346	37.0	79.0	8.50
A1208.6	–	8.60	0.3386	40.0	84.0	8.60
A1208.7	–	8.70	0.3425	40.0	84.0	8.70
A12011/32	11/32	8.73	0.3438	40.0	84.0	8.73
A1208.8	–	8.80	0.3465	40.0	84.0	8.80
A1208.9	–	8.90	0.3504	40.0	84.0	8.90
A1209.0	–	9.00	0.3543	40.0	84.0	9.00
A1209.1	–	9.10	0.3583	40.0	84.0	9.10
A1209.2	–	9.20	0.3622	40.0	84.0	9.20
A1209.3	–	9.30	0.3661	40.0	84.0	9.30
A1209.4	–	9.40	0.3701	40.0	84.0	9.40

Produkt	DC	DC	DC	LCF	OAL	D CON MS
	(inch)	(mm)	(inch)	(mm)	(mm)	(mm)
A1209.5	–	9.50	0.3740	40.0	84.0	9.50
A1203/8	3/8	9.52	0.3750	43.0	89.0	9.52
A1209.6	–	9.60	0.3780	43.0	89.0	9.60
A1209.7	–	9.70	0.3819	43.0	89.0	9.70
A1209.8	–	9.80	0.3858	43.0	89.0	9.80
A1209.9	–	9.90	0.3898	43.0	89.0	9.90
A12010.0	–	10.00	0.3937	43.0	89.0	10.00
A12010.1	–	10.10	0.3976	43.0	89.0	10.10
A12010.2	–	10.20	0.4016	43.0	89.0	10.20
A12010.3	–	10.30	0.4055	43.0	89.0	10.30
A12013/32	13/32	10.32	0.4063	43.0	89.0	10.32
A12010.4	–	10.40	0.4094	43.0	89.0	10.40
A12010.5	–	10.50	0.4134	43.0	89.0	10.50
A12010.6	–	10.60	0.4173	43.0	89.0	10.60
A12010.7	–	10.70	0.4213	47.0	95.0	10.70
A12010.8	–	10.80	0.4252	47.0	95.0	10.80
A12010.9	–	10.90	0.4291	47.0	95.0	10.90
A12011.0	–	11.00	0.4331	47.0	95.0	11.00
A12011.1	–	11.10	0.4370	47.0	95.0	11.10
A1207/16	7/16	11.11	0.4375	47.0	95.0	11.11
A12011.2	–	11.20	0.4409	47.0	95.0	11.20
A12011.3	–	11.30	0.4449	47.0	95.0	11.30
A12011.5	–	11.50	0.4528	47.0	95.0	11.50
A12011.6	–	11.60	0.4567	47.0	95.0	11.60
A12011.7	–	11.70	0.4606	47.0	95.0	11.70
A12011.8	–	11.80	0.4646	47.0	95.0	11.80
A12011.9	–	11.90	0.4685	51.0	102.0	11.90
A12012.0	–	12.00	0.4724	51.0	102.0	12.00
A12012.1	–	12.10	0.4764	51.0	102.0	12.10
A12012.2	–	12.20	0.4803	51.0	102.0	12.20
A12012.5	–	12.50	0.4921	51.0	102.0	12.50
A1201/2	1/2	12.70	0.5000	51.0	102.0	12.70
A12013.0	–	13.00	0.5118	51.0	102.0	13.00
A12013.5	–	13.50	0.5315	54.0	107.0	13.50
A12014.0	–	14.00	0.5512	54.0	107.0	14.00
A1209/16	9/16	14.29	0.5625	56.0	111.0	14.29
A12014.5	–	14.50	0.5709	56.0	111.0	14.50
A12015.0	–	15.00	0.5906	56.0	111.0	15.00
A12015.5	–	15.50	0.6102	58.0	115.0	15.50
A1205/8	5/8	15.88	0.6250	58.0	115.0	15.88
A12016.0	–	16.00	0.6299	58.0	115.0	16.00
A12016.5	–	16.50	0.6496	60.0	119.0	16.50
A12017.0	–	17.00	0.6693	60.0	119.0	17.00
A12011/16	11/16	17.46	0.6875	62.0	123.0	17.46
A12017.5	–	17.50	0.6890	62.0	123.0	17.50
A12018.0	–	18.00	0.7087	62.0	123.0	18.00
A12018.5	–	18.50	0.7283	64.0	127.0	18.50
A12019.0	–	19.00	0.7480	64.0	127.0	19.00
A1203/4	3/4	19.05	0.7500	66.0	131.0	19.05
A12019.5	–	19.50	0.7677	66.0	131.0	19.50
A12020.0	–	20.00	0.7874	66.0	131.0	20.00
A12020.5	–	20.50	0.8071	68.0	136.0	20.50
A12013/16	13/16	20.64	0.8125	68.0	136.0	20.64
A12021.0	–	21.00	0.8268	68.0	136.0	21.00
A12022.0	–	22.00	0.8661	70.0	141.0	22.00
A1207/8	7/8	22.22	0.8750	70.0	141.0	22.22
A12023.0	–	23.00	0.9055	72.0	146.0	23.00
A12015/16	15/16	23.81	0.9375	75.0	151.0	23.81
A12024.0	–	24.00	0.9449	75.0	151.0	24.00
A12025.0	–	25.00	0.9843	75.0	151.0	25.00



A022



HSS Navrtávák, Povlakovaný TiN

Univerzální vrták s vrcholovým úhlem 135° a speciální geometrie břítu napomáhá vystředění při ručním vrtání a při strojním vrtání zpřesňuje otvory a zlepšuje kvalitu povrchu. Povlak TiN zvyšuje produktivitu a prodlužuje životnost. Vhodný pro širokou oblast materiálů.

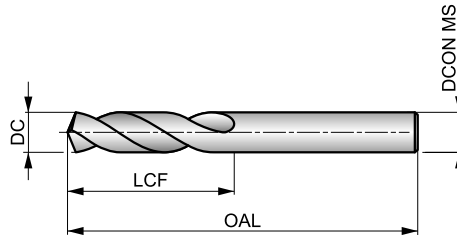

HSS	DIN ANSI	2.5×D
135°	TiN-Tip	
λ 20-35°	R	DC h8

Skupiny obráběných materiálů, startovní řezná rychlost (Vc m/min) a kód posuvu. Tabulku s posuvem na otáčku naleznete od strany 175.

P1.1 ■ 33 K	P1.2 ■ 37 K	P1.3 ■ 38 K	P2.1 ■ 28 K	P2.2 ■ 25 I	P2.3 ■ 22 G	P3.1 ■ 24 H	P3.2 ■ 19 H	P3.3 ■ 16 G	P4.1 ■ 14 H	P4.2 ■ 12 G	P4.3 ▣ 10 E	M1.1 ■ 21 G	M1.2 ■ 17 G
M2.1 ■ 18 G	M2.2 ■ 15 G	M3.1 ▣ 9 I	M3.2 ▣ 8 I	M3.3 ▣ 7 I	M4.1 ▣ 9 E	K1.1 ■ 32 K	K1.2 ■ 24 I	K1.3 ■ 18 I	K2.1 ■ 25 G	K2.2 ■ 20 G	K2.3 ▣ 16 G	K3.1 ■ 22 G	K3.2 ■ 17 G
K3.3 ▣ 13 G	K4.1 ■ 20 G	K4.2 ■ 15 G	K4.3 ▣ 11 G	K4.4 ▣ 10 G	K4.5 ▣ 8 G	K5.1 ■ 23 G	K5.2 ■ 17 G	K5.3 ▣ 13 G	N1.1 ■ 40 F	N1.2 ■ 30 F	N1.3 ■ 20 K	N2.1 ■ 49 J	N2.2 ■ 44 J
N2.3 ■ 32 J	N3.1 ▣ 64 I	N3.2 ▣ 38 K	N3.3 ▣ 19 H	N4.1 ▣ 30 K	N4.2 ▣ 35 I	N4.3 ▣ 17 G	S1.1 ■ 25 I	S1.2 ▣ 14 F	S1.3 ▣ 8 C	S2.1 ▣ 11 F	S2.2 ▣ 6 B	S3.1 ▣ 8 F	S3.2 ▣ 4 B
S4.1 ▣ 6 F	S4.2 ▣ 3 B												

DC < 2 mm - leštěný; DC >= 2 mm - TiN na hrotu a s příčným ostrím.
Produkty nabízíme i v sadě. Vyhledejte A088.

Produkt	DC (inch)	DC (mm)	DC (inch)	LCF (mm)	OAL (mm)	DCON MS (mm)
A022.5	–	0.50	0.0197	3.0	20.0	0.50
A022.6	–	0.60	0.0236	3.5	21.0	0.60
A022.7	–	0.70	0.0276	4.5	23.0	0.70
A0221/32	1/32	0.79	0.0313	13.0	35.0	0.79
A022.8	–	0.80	0.0315	5.0	24.0	0.80
A022.9	–	0.90	0.0354	5.5	25.0	0.90
A0221.0	–	1.00	0.0394	6.0	26.0	1.00
A0221.1	–	1.10	0.0433	7.0	28.0	1.10
A0223/64	3/64	1.19	0.0469	13.0	35.0	1.19
A0221.2	–	1.20	0.0472	8.0	30.0	1.20
A0221.3	–	1.30	0.0512	8.0	30.0	1.30
A0221.4	–	1.40	0.0551	9.0	32.0	1.40
A0221.5	–	1.50	0.0591	9.0	32.0	1.50
A0221/16	1/16	1.59	0.0625	16.0	41.0	1.59
A0221.6	–	1.60	0.0630	10.0	34.0	1.60
A0221.7	–	1.70	0.0669	10.0	34.0	1.70
A0221.8	–	1.80	0.0709	11.0	36.0	1.80
A0221.9	–	1.90	0.0748	11.0	36.0	1.90
A0225/64	5/64	1.98	0.0781	17.0	43.0	1.98
A0222.0	–	2.00	0.0787	12.0	38.0	2.00
A0222.1	–	2.10	0.0827	12.0	38.0	2.10
A0222.2	–	2.20	0.0866	13.0	40.0	2.20

Produkt	DC (inch)	DC (mm)	DC (inch)	LCF (mm)	OAL (mm)	DCON MS (mm)
A0222.25	–	2.25	0.0886	13.0	40.0	2.25
A0222.3	–	2.30	0.0906	13.0	40.0	2.30
A0223/32	3/32	2.38	0.0938	20.0	45.0	2.38
A0222.4	–	2.40	0.0945	14.0	43.0	2.40
A0222.5	–	2.50	0.0984	14.0	43.0	2.50
A0222.6	–	2.60	0.1024	14.0	43.0	2.60
A0222.65	–	2.65	0.1043	14.0	43.0	2.65
A0222.7	–	2.70	0.1063	16.0	46.0	2.70
A0227/64	7/64	2.78	0.1094	22.0	47.0	2.78
A0222.8	–	2.80	0.1102	16.0	46.0	2.80
A0222.9	–	2.90	0.1142	16.0	46.0	2.90
A0223.0	–	3.00	0.1181	16.0	46.0	3.00
A0223.1	–	3.10	0.1220	18.0	49.0	3.10
A0221/8	1/8	3.18	0.1250	23.0	49.0	3.18
A0223.2	–	3.20	0.1260	18.0	49.0	3.20
A0223.25	–	3.25	0.1280	18.0	49.0	3.25
A0223.3	–	3.30	0.1299	18.0	49.0	3.30
A0223.4	–	3.40	0.1339	20.0	52.0	3.40
A0223.5	–	3.50	0.1378	20.0	52.0	3.50
A0229/64	9/64	3.57	0.1406	25.0	50.0	3.57
A0223.6	–	3.60	0.1417	20.0	52.0	3.60
A0223.7	–	3.70	0.1457	20.0	52.0	3.70



Produkt	DC	DC	DC	LCF	OAL	D CON MS
	(inch)	(mm)	(inch)	(mm)	(mm)	(mm)
A0223.8	–	3.80	0.1496	22.0	55.0	3.80
A0223.9	–	3.90	0.1535	22.0	55.0	3.90
A0225/32	5/32	3.97	0.1563	26.0	53.0	3.97
A0224.0	–	4.00	0.1575	22.0	55.0	4.00
A0224.1	–	4.10	0.1614	22.0	55.0	4.10
A0224.2	–	4.20	0.1654	22.0	55.0	4.20
A0224.3	–	4.30	0.1693	24.0	58.0	4.30
A02211/64	11/64	4.37	0.1719	28.0	55.0	4.37
A0224.4	–	4.40	0.1732	24.0	58.0	4.40
A0224.5	–	4.50	0.1772	24.0	58.0	4.50
A0224.6	–	4.60	0.1811	24.0	58.0	4.60
A0224.7	–	4.70	0.1850	24.0	58.0	4.70
A0223/16	3/16	4.76	0.1875	30.0	57.0	4.76
A0224.8	–	4.80	0.1890	26.0	62.0	4.80
A0224.9	–	4.90	0.1929	26.0	62.0	4.90
A0225.0	–	5.00	0.1969	26.0	62.0	5.00
A0225.1	–	5.10	0.2008	26.0	62.0	5.10
A02213/64	13/64	5.16	0.2031	31.0	58.0	5.16
A0225.2	–	5.20	0.2047	26.0	62.0	5.20
A0225.3	–	5.30	0.2087	26.0	62.0	5.30
A0225.4	–	5.40	0.2126	28.0	66.0	5.40
A0225.5	–	5.50	0.2165	28.0	66.0	5.50
A0227/32	7/32	5.56	0.2188	33.0	61.0	5.56
A0225.6	–	5.60	0.2205	28.0	66.0	5.60
A0225.7	–	5.70	0.2244	28.0	66.0	5.70
A0225.8	–	5.80	0.2283	28.0	66.0	5.80
A0225.9	–	5.90	0.2323	28.0	66.0	5.90
A02215/64	15/64	5.95	0.2344	34.0	63.0	5.95
A0226.0	–	6.00	0.2362	28.0	66.0	6.00
A0226.1	–	6.10	0.2402	31.0	70.0	6.10
A0226.2	–	6.20	0.2441	31.0	70.0	6.20
A0226.3	–	6.30	0.2480	31.0	70.0	6.30
A0221/4	1/4	6.35	0.2500	36.0	65.0	6.35
A0226.4	–	6.40	0.2520	31.0	70.0	6.40
A0226.5	–	6.50	0.2559	31.0	70.0	6.50
A0226.6	–	6.60	0.2598	31.0	70.0	6.60
A0226.7	–	6.70	0.2638	31.0	70.0	6.70
A0226.8	–	6.80	0.2677	34.0	74.0	6.80
A0226.9	–	6.90	0.2717	34.0	74.0	6.90
A0227.0	–	7.00	0.2756	34.0	74.0	7.00
A0227.1	–	7.10	0.2795	34.0	74.0	7.10
A0229/32	9/32	7.14	0.2813	40.0	70.0	7.14
A0227.2	–	7.20	0.2835	34.0	74.0	7.20
A0227.3	–	7.30	0.2874	34.0	74.0	7.30
A0227.4	–	7.40	0.2913	34.0	74.0	7.40
A0227.5	–	7.50	0.2953	34.0	74.0	7.50
A0227.6	–	7.60	0.2992	37.0	79.0	7.60
A0227.7	–	7.70	0.3031	37.0	79.0	7.70
A0227.8	–	7.80	0.3071	37.0	79.0	7.80
A0227.9	–	7.90	0.3110	37.0	79.0	7.90
A0225/16	5/16	7.94	0.3125	43.0	73.0	7.94
A0228.0	–	8.00	0.3150	37.0	79.0	8.00
A0228.1	–	8.10	0.3189	37.0	79.0	8.10
A0228.2	–	8.20	0.3228	37.0	79.0	8.20

Produkt	DC	DC	DC	LCF	OAL	D CON MS
	(inch)	(mm)	(inch)	(mm)	(mm)	(mm)
A0228.3	–	8.30	0.3268	37.0	79.0	8.30
A0228.4	–	8.40	0.3307	37.0	79.0	8.40
A0228.5	–	8.50	0.3346	37.0	79.0	8.50
A0228.6	–	8.60	0.3386	40.0	84.0	8.60
A0228.7	–	8.70	0.3425	40.0	84.0	8.70
A02211/32	11/32	8.73	0.3438	45.0	78.0	8.73
A0228.8	–	8.80	0.3465	40.0	84.0	8.80
A0228.9	–	8.90	0.3504	40.0	84.0	8.90
A0229.0	–	9.00	0.3543	40.0	84.0	9.00
A0229.1	–	9.10	0.3583	40.0	84.0	9.10
A0229.2	–	9.20	0.3622	40.0	84.0	9.20
A0229.3	–	9.30	0.3661	40.0	84.0	9.30
A0229.4	–	9.40	0.3701	40.0	84.0	9.40
A0229.5	–	9.50	0.3740	40.0	84.0	9.50
A0223/8	3/8	9.52	0.3750	48.0	81.0	9.52
A0229.6	–	9.60	0.3780	43.0	89.0	9.60
A0229.7	–	9.70	0.3819	43.0	89.0	9.70
A0229.8	–	9.80	0.3858	43.0	89.0	9.80
A0229.9	–	9.90	0.3898	43.0	89.0	9.90
A02210.0	–	10.00	0.3937	43.0	89.0	10.00
A02210.1	–	10.10	0.3976	43.0	89.0	10.10
A02210.2	–	10.20	0.4016	43.0	89.0	10.20
A02210.3	–	10.30	0.4055	43.0	89.0	10.30
A02213/32	13/32	10.32	0.4063	51.0	86.0	10.32
A02210.4	–	10.40	0.4094	43.0	89.0	10.40
A02210.5	–	10.50	0.4134	43.0	89.0	10.50
A02210.6	–	10.60	0.4173	43.0	89.0	10.60
A02210.7	–	10.70	0.4213	47.0	95.0	10.70
A02210.8	–	10.80	0.4252	47.0	95.0	10.80
A02210.9	–	10.90	0.4291	47.0	95.0	10.90
A02211.0	–	11.00	0.4331	47.0	95.0	11.00
A02211.1	–	11.10	0.4370	47.0	95.0	11.10
A0227/16	7/16	11.11	0.4375	54.0	89.0	11.11
A02211.2	–	11.20	0.4409	47.0	95.0	11.20
A02211.3	–	11.30	0.4449	47.0	95.0	11.30
A02211.5	–	11.50	0.4528	47.0	95.0	11.50
A02211.6	–	11.60	0.4567	47.0	95.0	11.60
A02211.7	–	11.70	0.4606	47.0	95.0	11.70
A02211.8	–	11.80	0.4646	47.0	95.0	11.80
A02211.9	–	11.90	0.4685	51.0	102.0	11.90
A02212.0	–	12.00	0.4724	51.0	102.0	12.00
A02212.1	–	12.10	0.4764	51.0	102.0	12.10
A02212.2	–	12.20	0.4803	51.0	102.0	12.20
A02212.5	–	12.50	0.4921	51.0	102.0	12.50
A0221/2	1/2	12.70	0.5000	60.0	98.0	12.70
A02213.0	–	13.00	0.5118	51.0	102.0	13.00
A02213.5	–	13.50	0.5315	54.0	107.0	13.50
A02214.0	–	14.00	0.5512	54.0	107.0	14.00
A0229/16	9/16	14.29	0.5625	67.0	105.0	14.29
A02214.5	–	14.50	0.5709	56.0	111.0	14.50
A02215.0	–	15.00	0.5906	56.0	111.0	15.00
A02215.5	–	15.50	0.6102	58.0	115.0	15.50
A0225/8	5/8	15.88	0.6250	73.0	111.0	15.88
A02216.0	–	16.00	0.6299	58.0	115.0	16.00



A620



HSS-E (5 % kobaltu) Navrtávák, Povrchová úprava Bronz

Vrták s vrcholovým úhlem 135° napomáhá vystředění vrtáku a snižuje řezné síly. Bronzový povrch je tenká oxidační vrstva použitá na HSS-E vrtácích s obsahem kobaltu. Vhodný pro širokou oblast obráběných materiálů. Nedoporučuje se pro ruční operace.

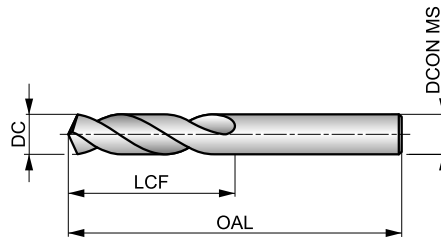

HSS-E	DIN 1897	2.5×D
130°	Bronze	
λ 20-35°	R	DC h8

Skupiny obráběných materiálů, startovní řezná rychlost (Vc m/min) a kód posuvu. Tabulku s posuvem na otáčku naleznete od strany 175.

P1.1 ■ 40 H	P1.2 ■ 45 H	P1.3 ■ 46 H	P2.1 ■ 34 H	P2.2 ■ 30 G	P2.3 ■ 27 F	P3.1 ■ 27 G	P3.2 ■ 21 G	P3.3 ■ 18 F	P4.1 ■ 16 G	P4.2 ■ 13 F	P4.3 ■ 11 E	M1.1 ■ 30 F	M1.2 ■ 26 F
M2.1 ■ 27 F	M2.2 ■ 22 F	M3.1 ■ 13 H	M3.2 ■ 11 H	M3.3 ■ 10 H	M4.1 ■ 15 D	K1.1 ■ 34 K	K1.2 ■ 25 F	K1.3 ■ 19 F	K2.1 ■ 27 F	K2.2 ■ 22 F	K2.3 ■ 18 F	K3.1 ■ 24 F	K3.2 ■ 18 F
K3.3 ■ 15 F	K4.1 ■ 22 F	K4.2 ■ 17 F	K4.3 ■ 12 F	K4.4 ■ 11 F	K4.5 ■ 9 F	K5.1 ■ 25 F	K5.2 ■ 19 F	K5.3 ■ 15 F	N1.1 ■ 40 K	N1.2 ■ 30 K	N1.3 ■ 20 J	N2.1 ■ 49 I	N2.2 ■ 44 I
N2.3 ■ 32 I	N3.1 ■ 68 J	N3.2 ■ 40 K	N3.3 ■ 20 I	N4.1 ■ 40 L	N4.2 ■ 32 K	N4.3 ■ 18 I	S1.1 ■ 30 G	S1.2 ■ 18 F	S1.3 ■ 10 C	S2.1 ■ 12 F	S2.2 ■ 8 C	S3.1 ■ 9 F	S3.2 ■ 6 C
S4.1 ■ 7 F	S4.2 ■ 5 C												

Produkt	DC	DC	LCF	OAL	DCON MS
	(mm)	(inch)			
A6202.5	2.50	0.0984	14.0	43.0	2.50
A6202.6	2.60	0.1024	14.0	43.0	2.60
A6202.7	2.70	0.1063	16.0	46.0	2.70
A6202.8	2.80	0.1102	16.0	46.0	2.80
A6202.9	2.90	0.1142	16.0	46.0	2.90
A6203.0	3.00	0.1181	16.0	46.0	3.00
A6203.1	3.10	0.1220	18.0	49.0	3.10
A6203.2	3.20	0.1260	18.0	49.0	3.20
A6203.3	3.30	0.1299	18.0	49.0	3.30
A6203.4	3.40	0.1339	20.0	52.0	3.40
A6203.5	3.50	0.1378	20.0	52.0	3.50
A6203.6	3.60	0.1417	20.0	52.0	3.60
A6203.7	3.70	0.1457	20.0	52.0	3.70
A6203.8	3.80	0.1496	22.0	55.0	3.80
A6203.9	3.90	0.1535	22.0	55.0	3.90
A6204.0	4.00	0.1575	22.0	55.0	4.00
A6204.1	4.10	0.1614	22.0	55.0	4.10
A6204.2	4.20	0.1654	22.0	55.0	4.20
A6204.3	4.30	0.1693	24.0	58.0	4.30
A6204.4	4.40	0.1732	24.0	58.0	4.40
A6204.5	4.50	0.1772	24.0	58.0	4.50
A6204.6	4.60	0.1811	24.0	58.0	4.60
A6204.7	4.70	0.1850	24.0	58.0	4.70
A6204.8	4.80	0.1890	26.0	62.0	4.80

Produkt	DC	DC	LCF	OAL	DCON MS
	(mm)	(inch)			
A6204.9	4.90	0.1929	26.0	62.0	4.90
A6205.0	5.00	0.1969	26.0	62.0	5.00
A6205.1	5.10	0.2008	26.0	62.0	5.10
A6205.2	5.20	0.2047	26.0	62.0	5.20
A6205.3	5.30	0.2087	26.0	62.0	5.30
A6205.4	5.40	0.2126	28.0	66.0	5.40
A6205.5	5.50	0.2165	28.0	66.0	5.50
A6205.6	5.60	0.2205	28.0	66.0	5.60
A6205.7	5.70	0.2244	28.0	66.0	5.70
A6205.8	5.80	0.2283	28.0	66.0	5.80
A6205.9	5.90	0.2323	28.0	66.0	5.90
A6206.0	6.00	0.2362	28.0	66.0	6.00
A6206.1	6.10	0.2402	31.0	70.0	6.10
A6206.2	6.20	0.2441	31.0	70.0	6.20
A6206.3	6.30	0.2480	31.0	70.0	6.30
A6206.4	6.40	0.2520	31.0	70.0	6.40
A6206.5	6.50	0.2559	31.0	70.0	6.50
A6206.6	6.60	0.2598	31.0	70.0	6.60
A6206.7	6.70	0.2638	31.0	70.0	6.70
A6206.8	6.80	0.2677	34.0	74.0	6.80
A6206.9	6.90	0.2717	34.0	74.0	6.90
A6207.0	7.00	0.2756	34.0	74.0	7.00
A6207.1	7.10	0.2795	34.0	74.0	7.10
A6207.2	7.20	0.2835	34.0	74.0	7.20



Produkt	DC	DC	LCF	OAL	DCON MS
	(mm)	(inch)	(mm)	(mm)	(mm)
A6207.3	7.30	0.2874	34.0	74.0	7.30
A6207.4	7.40	0.2913	34.0	74.0	7.40
A6207.5	7.50	0.2953	34.0	74.0	7.50
A6207.6	7.60	0.2992	37.0	79.0	7.60
A6207.7	7.70	0.3031	37.0	79.0	7.70
A6207.8	7.80	0.3071	37.0	79.0	7.80
A6207.9	7.90	0.3110	37.0	79.0	7.90
A6208.0	8.00	0.3150	37.0	79.0	8.00
A6208.1	8.10	0.3189	37.0	79.0	8.10
A6208.2	8.20	0.3228	37.0	79.0	8.20
A6208.3	8.30	0.3268	37.0	79.0	8.30
A6208.4	8.40	0.3307	37.0	79.0	8.40
A6208.5	8.50	0.3346	37.0	79.0	8.50
A6208.6	8.60	0.3386	40.0	84.0	8.60
A6208.7	8.70	0.3425	40.0	84.0	8.70
A6208.8	8.80	0.3465	40.0	84.0	8.80
A6208.9	8.90	0.3504	40.0	84.0	8.90
A6209.0	9.00	0.3543	40.0	84.0	9.00
A6209.1	9.10	0.3583	40.0	84.0	9.10
A6209.2	9.20	0.3622	40.0	84.0	9.20

Produkt	DC	DC	LCF	OAL	DCON MS
	(mm)	(inch)	(mm)	(mm)	(mm)
A6209.3	9.30	0.3661	40.0	84.0	9.30
A6209.4	9.40	0.3701	40.0	84.0	9.40
A6209.5	9.50	0.3740	40.0	84.0	9.50
A6209.6	9.60	0.3780	43.0	89.0	9.60
A6209.7	9.70	0.3819	43.0	89.0	9.70
A6209.8	9.80	0.3858	43.0	89.0	9.80
A6209.9	9.90	0.3898	43.0	89.0	9.90
A62010.0	10.00	0.3937	43.0	89.0	10.00
A62010.2	10.20	0.4016	43.0	89.0	10.20
A62010.3	10.30	0.4055	43.0	89.0	10.30
A62010.4	10.40	0.4094	43.0	89.0	10.40
A62010.5	10.50	0.4134	43.0	89.0	10.50
A62010.8	10.80	0.4252	47.0	95.0	10.80
A62011.0	11.00	0.4331	47.0	95.0	11.00
A62011.5	11.50	0.4528	47.0	95.0	11.50
A62012.0	12.00	0.4724	51.0	102.0	12.00
A62012.2	12.20	0.4803	51.0	102.0	12.20
A62012.5	12.50	0.4921	51.0	102.0	12.50
A62012.8	12.80	0.5039	51.0	102.0	12.80
A62013.0	13.00	0.5118	51.0	102.0	13.00



A117



HSS-E (8% kobaltu) Navrtávák, Povrchová úprava Bronze

Vrták doporučený pro těžko obrábitelné materiály a obtížné operace. Vrcholový úhel 135° napomáhá vystředění vrtáku a snižuje řezné síly. Bronzový povrch je tenká oxidační vrstva použitá na HSS-E vrtácích s 8% kobaltu.

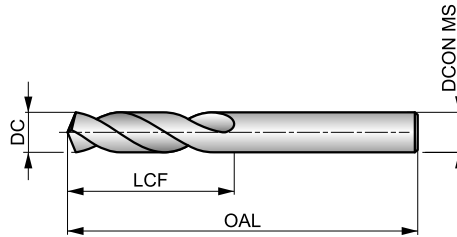

HSS-E	DIN 1897	2.5×D
135°	Bronze	
λ 20-35°	R	DC h8

Skupiny obráběných materiálů, startovní řezná rychlost (Vc m/min) a kód posuvu. Tabulku s posuvem na otáčku naleznete od strany 175.

P1.1 ■ 40 H	P1.2 ■ 45 H	P1.3 ■ 46 H	P2.1 ■ 34 H	P2.2 ■ 30 G	P2.3 ■ 27 F	P3.1 ■ 27 G	P3.2 ■ 21 G	P3.3 ■ 18 F	P4.1 ■ 16 G	P4.2 ■ 13 F	P4.3 ■ 11 E	M1.1 ■ 30 F	M1.2 ■ 26 F
M2.1 ■ 27 F	M2.2 ■ 22 F	M3.1 ■ 13 H	M3.2 ■ 11 H	M3.3 ■ 10 H	M4.1 ■ 15 D	K1.1 ■ 34 K	K1.2 ■ 25 F	K1.3 ■ 19 F	K2.1 ■ 27 F	K2.2 ■ 22 F	K2.3 ■ 18 F	K3.1 ■ 24 F	K3.2 ■ 18 F
K3.3 ■ 15 F	K4.1 ■ 22 F	K4.2 ■ 17 F	K4.3 ■ 12 F	K4.4 ■ 11 F	K4.5 ■ 9 F	K5.1 ■ 25 F	K5.2 ■ 19 F	K5.3 ■ 15 F	N1.1 ■ 35 K	N1.2 ■ 26 K	N1.3 ■ 18 J	N2.1 ■ 48 I	N2.2 ■ 43 I
N2.3 ■ 31 I	N3.1 ■ 68 J	N3.2 ■ 40 K	N3.3 ■ 20 I	N4.1 ■ 35 M	N4.2 ■ 28 K	N4.3 ■ 17 I	S1.1 ■ 30 G	S1.2 ■ 18 F	S1.3 ■ 10 C	S2.1 ■ 12 F	S2.2 ■ 8 C	S3.1 ■ 9 F	S3.2 ■ 6 C
S4.1 ■ 7 F	S4.2 ■ 5 C												

DC ≤ 1.5mm - 118° úhel špičky; DC < 3.00mm 5% kobaltu.

Produkt	DC (inch)	DC (mm)	DC (inch)	LCF (mm)	OAL (mm)	D CON MS (mm)
A1171.0	–	1.00	0.0394	6.0	26.0	1.00
A1171.1	–	1.10	0.0433	7.0	28.0	1.10
A1171.2	–	1.20	0.0472	8.0	30.0	1.20
A1171.3	–	1.30	0.0512	8.0	30.0	1.30
A1171.4	–	1.40	0.0551	9.0	32.0	1.40
A1171.5	–	1.50	0.0591	9.0	32.0	1.50
A1171.6	–	1.60	0.0630	10.0	34.0	1.60
A1171.7	–	1.70	0.0669	10.0	34.0	1.70
A1171.8	–	1.80	0.0709	11.0	36.0	1.80
A1171.9	–	1.90	0.0748	11.0	36.0	1.90
A1172.0	–	2.00	0.0787	12.0	38.0	2.00
A1172.1	–	2.10	0.0827	12.0	38.0	2.10
A1172.2	–	2.20	0.0866	13.0	40.0	2.20
A1172.3	–	2.30	0.0906	13.0	40.0	2.30
A1172.4	–	2.40	0.0945	14.0	43.0	2.40
A1172.5	–	2.50	0.0984	14.0	43.0	2.50
A1172.6	–	2.60	0.1024	14.0	43.0	2.60
A1172.7	–	2.70	0.1063	16.0	46.0	2.70
A1172.8	–	2.80	0.1102	16.0	46.0	2.80
A1172.9	–	2.90	0.1142	16.0	46.0	2.90
A1173.0	–	3.00	0.1181	16.0	46.0	3.00
A1173.1	–	3.10	0.1220	18.0	49.0	3.10
A1171/8	1/8	3.18	0.1250	18.0	49.0	3.18

Produkt	DC (inch)	DC (mm)	DC (inch)	LCF (mm)	OAL (mm)	D CON MS (mm)
A1173.2	–	3.20	0.1260	18.0	49.0	3.20
A1173.3	–	3.30	0.1299	18.0	49.0	3.30
A1173.4	–	3.40	0.1339	20.0	52.0	3.40
A1173.5	–	3.50	0.1378	20.0	52.0	3.50
A1173.6	–	3.60	0.1417	20.0	52.0	3.60
A1173.7	–	3.70	0.1457	20.0	52.0	3.70
A1173.8	–	3.80	0.1496	22.0	55.0	3.80
A1173.9	–	3.90	0.1535	22.0	55.0	3.90
A1175/32	5/32	3.97	0.1563	22.0	55.0	3.97
A1174.0	–	4.00	0.1575	22.0	55.0	4.00
A1174.1	–	4.10	0.1614	22.0	55.0	4.10
A1174.2	–	4.20	0.1654	22.0	55.0	4.20
A1174.3	–	4.30	0.1693	24.0	58.0	4.30
A1174.4	–	4.40	0.1732	24.0	58.0	4.40
A1174.5	–	4.50	0.1772	24.0	58.0	4.50
A1174.6	–	4.60	0.1811	24.0	58.0	4.60
A1174.7	–	4.70	0.1850	24.0	58.0	4.70
A1173/16	3/16	4.76	0.1875	26.0	62.0	4.76
A1174.8	–	4.80	0.1890	26.0	62.0	4.80
A1174.9	–	4.90	0.1929	26.0	62.0	4.90
A1175.0	–	5.00	0.1969	26.0	62.0	5.00
A1175.1	–	5.10	0.2008	26.0	62.0	5.10
A1175.2	–	5.20	0.2047	26.0	62.0	5.20



Produkt	DC	DC	DC	LCF	OAL	DCON MS
	(inch)	(mm)	(inch)	(mm)	(mm)	(mm)
A1175.3	–	5.30	0.2087	26.0	62.0	5.30
A1175.4	–	5.40	0.2126	28.0	66.0	5.40
A1175.5	–	5.50	0.2165	28.0	66.0	5.50
A1175.6	–	5.60	0.2205	28.0	66.0	5.60
A1175.7	–	5.70	0.2244	28.0	66.0	5.70
A1175.8	–	5.80	0.2283	28.0	66.0	5.80
A1175.9	–	5.90	0.2323	28.0	66.0	5.90
A1176.0	–	6.00	0.2362	28.0	66.0	6.00
A1176.1	–	6.10	0.2402	31.0	70.0	6.10
A1176.2	–	6.20	0.2441	31.0	70.0	6.20
A1176.3	–	6.30	0.2480	31.0	70.0	6.30
A1171/4	1/4	6.35	0.2500	31.0	70.0	6.35
A1176.4	–	6.40	0.2520	31.0	70.0	6.40
A1176.5	–	6.50	0.2559	31.0	70.0	6.50
A1176.6	–	6.60	0.2598	31.0	70.0	6.60
A1176.7	–	6.70	0.2638	31.0	70.0	6.70
A1176.8	–	6.80	0.2677	34.0	74.0	6.80
A1176.9	–	6.90	0.2717	34.0	74.0	6.90
A1177.0	–	7.00	0.2756	34.0	74.0	7.00
A1177.1	–	7.10	0.2795	34.0	74.0	7.10
A1177.2	–	7.20	0.2835	34.0	74.0	7.20
A1177.3	–	7.30	0.2874	34.0	74.0	7.30
A1177.4	–	7.40	0.2913	34.0	74.0	7.40
A1177.5	–	7.50	0.2953	34.0	74.0	7.50
A1177.6	–	7.60	0.2992	37.0	79.0	7.60
A1177.7	–	7.70	0.3031	37.0	79.0	7.70
A1177.8	–	7.80	0.3071	37.0	79.0	7.80
A1177.9	–	7.90	0.3110	37.0	79.0	7.90
A1175/16	5/16	7.94	0.3125	37.0	79.0	7.94

Produkt	DC	DC	DC	LCF	OAL	DCON MS
	(inch)	(mm)	(inch)	(mm)	(mm)	(mm)
A1178.0	–	8.00	0.3150	37.0	79.0	8.00
A1178.1	–	8.10	0.3189	37.0	79.0	8.10
A1178.2	–	8.20	0.3228	37.0	79.0	8.20
A1178.3	–	8.30	0.3268	37.0	79.0	8.30
A1178.4	–	8.40	0.3307	37.0	79.0	8.40
A1178.5	–	8.50	0.3346	37.0	79.0	8.50
A1178.6	–	8.60	0.3386	40.0	84.0	8.60
A1178.7	–	8.70	0.3425	40.0	84.0	8.70
A1178.8	–	8.80	0.3465	40.0	84.0	8.80
A1178.9	–	8.90	0.3504	40.0	84.0	8.90
A1179.0	–	9.00	0.3543	40.0	84.0	9.00
A1179.1	–	9.10	0.3583	40.0	84.0	9.10
A1179.2	–	9.20	0.3622	40.0	84.0	9.20
A1179.3	–	9.30	0.3661	40.0	84.0	9.30
A1179.4	–	9.40	0.3701	40.0	84.0	9.40
A1179.5	–	9.50	0.3740	40.0	84.0	9.50
A1173/8	3/8	9.52	0.3750	43.0	89.0	9.52
A1179.6	–	9.60	0.3780	43.0	89.0	9.60
A1179.7	–	9.70	0.3819	43.0	89.0	9.70
A1179.8	–	9.80	0.3858	43.0	89.0	9.80
A1179.9	–	9.90	0.3898	43.0	89.0	9.90
A11710.0	–	10.00	0.3937	43.0	89.0	10.00
A11710.2	–	10.20	0.4016	43.0	89.0	10.20
A11710.5	–	10.50	0.4134	43.0	89.0	10.50
A11711.0	–	11.00	0.4331	47.0	95.0	11.00
A11711.5	–	11.50	0.4528	47.0	95.0	11.50
A11712.0	–	12.00	0.4724	51.0	102.0	12.00
A1171/2	1/2	12.70	0.5000	51.0	102.0	12.70
A11713.0	–	13.00	0.5118	51.0	102.0	13.00



A520



ADX HSS Vrták krátký, Povlakovaný TiN

Produktivní vrták pro kvalitní a přesné otvory, vhodný pro vysoké řezné rychlosti a velké posuvy (tolerance otvorů H9). Vrcholový úhel 130°, příčné ostří usnadňuje vystředění a snižuje řezné síly. Tento vrták by měl být používán na strojích s konstantním posuvem. Povlak TiN zvyšuje produktivitu a prodlužuje životnost.



ADX

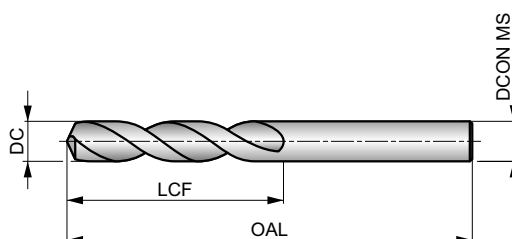

HSS	DIN 1897	2.5×D
130°	TiN	
λ 32-40°	R	DC h8

Skupiny obráběných materiálů, startovní řezná rychlost (Vc m/min) a kód posuvu. Tabulku s posuvem na otáčku naleznete od strany 175.

P1.1 ■ 53 M	P1.2 ■ 59 M	P1.3 ■ 61 M	P2.1 ■ 45 M	P2.2 ■ 40 K	P2.3 ■ 35 G	P3.1 ■ 31 I	P3.2 ■ 25 I	P3.3 ■ 21 G	P4.1 ■ 19 I	P4.2 ■ 16 G	P4.3 ■ 13 E	M1.1 ■ 41 I	M1.2 ■ 35 I
M2.1 ■ 37 I	M2.2 ■ 30 I	M3.1 ■ 19 I	M3.2 ■ 16 I	M3.3 ■ 14 I	M4.1 ■ 20 G	K1.1 ■ 48 M	K1.2 ■ 36 K	K1.3 ■ 27 K	K2.1 ■ 37 J	K2.2 ■ 30 J	K2.3 ■ 24 F	K3.1 ■ 33 J	K3.2 ■ 25 J
K3.3 ■ 20 F	K4.1 ■ 30 J	K4.2 ■ 23 J	K4.3 ■ 17 F	K4.4 ■ 14 F	K4.5 ■ 12 F	K5.1 ■ 34 J	K5.2 ■ 26 J	K5.3 ■ 20 F	N1.1 ■ 55 I	N1.2 ■ 41 I	N1.3 ■ 28 M	N2.1 ■ 57 K	N2.2 ■ 51 K
N2.3 ■ 37 K	N3.1 ■ 85 K	N3.2 ■ 50 I	N3.3 ■ 25 E	N4.1 ■ 65 G	N4.2 ■ 50 G	N4.3 ■ 35 F	S1.1 ■ 34 I	S1.2 ■ 20 G	S1.3 ■ 4 B	S2.1 ■ 15 G	S2.2 ■ 10 E	S3.1 ■ 11 G	S3.2 ■ 7 E
S4.1 ■ 9 G	S4.2 ■ 6 E												

Produkt	DC (inch)	DC (mm)	DC (inch)	LCF (mm)	OAL (mm)	DCON MS (mm)
A5203.0	–	3.00	0.1181	16.0	46.0	3.00
A5203.1	–	3.10	0.1220	18.0	49.0	3.10
A5201/8	1/8	3.18	0.1250	18.0	49.0	3.18
A5203.2	–	3.20	0.1260	18.0	49.0	3.20
A5203.3	–	3.30	0.1299	18.0	49.0	3.30
A5203.4	–	3.40	0.1339	20.0	52.0	3.40
A5203.5	–	3.50	0.1378	20.0	52.0	3.50
A5209/64	9/64	3.57	0.1406	20.0	52.0	3.57
A5203.6	–	3.60	0.1417	20.0	52.0	3.60
A5203.7	–	3.70	0.1457	20.0	52.0	3.70
A5203.8	–	3.80	0.1496	22.0	55.0	3.80
A5203.9	–	3.90	0.1535	22.0	55.0	3.90
A5205/32	5/32	3.97	0.1563	22.0	55.0	3.97
A5204.0	–	4.00	0.1575	22.0	55.0	4.00
A5204.1	–	4.10	0.1614	22.0	55.0	4.10
A5204.2	–	4.20	0.1654	22.0	55.0	4.20
A5204.3	–	4.30	0.1693	24.0	58.0	4.30
A52011/64	11/64	4.37	0.1719	24.0	58.0	4.37
A5204.4	–	4.40	0.1732	24.0	58.0	4.40
A5204.5	–	4.50	0.1772	24.0	58.0	4.50
A5204.6	–	4.60	0.1811	24.0	58.0	4.60
A5204.7	–	4.70	0.1850	24.0	58.0	4.70
A5203/16	3/16	4.76	0.1875	26.0	62.0	4.76
A5204.8	–	4.80	0.1890	26.0	62.0	4.80

Produkt	DC (inch)	DC (mm)	DC (inch)	LCF (mm)	OAL (mm)	DCON MS (mm)
A5204.9	–	4.90	0.1929	26.0	62.0	4.90
A5205.0	–	5.00	0.1969	26.0	62.0	5.00
A5205.1	–	5.10	0.2008	26.0	62.0	5.10
A52013/64	13/64	5.16	0.2031	26.0	62.0	5.16
A5205.2	–	5.20	0.2047	26.0	62.0	5.20
A5205.3	–	5.30	0.2087	26.0	62.0	5.30
A5205.4	–	5.40	0.2126	28.0	66.0	5.40
A5205.5	–	5.50	0.2165	28.0	66.0	5.50
A5207/32	7/32	5.56	0.2188	28.0	66.0	5.56
A5205.6	–	5.60	0.2205	28.0	66.0	5.60
A5205.7	–	5.70	0.2244	28.0	66.0	5.70
A5205.8	–	5.80	0.2283	28.0	66.0	5.80
A5205.9	–	5.90	0.2323	28.0	66.0	5.90
A52015/64	15/64	5.95	0.2344	28.0	66.0	5.95
A5206.0	–	6.00	0.2362	28.0	66.0	6.00
A5206.1	–	6.10	0.2402	31.0	70.0	6.10
A5206.2	–	6.20	0.2441	31.0	70.0	6.20
A5206.3	–	6.30	0.2480	31.0	70.0	6.30
A5201/4	1/4	6.35	0.2500	31.0	70.0	6.35
A5206.4	–	6.40	0.2520	31.0	70.0	6.40
A5206.5	–	6.50	0.2559	31.0	70.0	6.50
A5206.6	–	6.60	0.2598	31.0	70.0	6.60
A5206.7	–	6.70	0.2638	31.0	70.0	6.70
A52017/64	17/64	6.75	0.2656	34.0	74.0	6.75



Produkt	DC	DC	DC	LCF	OAL	D CON MS
	(inch)	(mm)	(inch)	(mm)	(mm)	(mm)
A5206.8	–	6.80	0.2677	34.0	74.0	6.80
A5206.9	–	6.90	0.2717	34.0	74.0	6.90
A5207.0	–	7.00	0.2756	34.0	74.0	7.00
A5207.1	–	7.10	0.2795	34.0	74.0	7.10
A5209/32	9/32	7.14	0.2813	34.0	74.0	7.14
A5207.2	–	7.20	0.2835	34.0	74.0	7.20
A5207.3	–	7.30	0.2874	34.0	74.0	7.30
A5207.4	–	7.40	0.2913	34.0	74.0	7.40
A5207.5	–	7.50	0.2953	34.0	74.0	7.50
A52019/64	19/64	7.54	0.2969	37.0	79.0	7.54
A5207.6	–	7.60	0.2992	37.0	79.0	7.60
A5207.7	–	7.70	0.3031	37.0	79.0	7.70
A5207.8	–	7.80	0.3071	37.0	79.0	7.80
A5207.9	–	7.90	0.3110	37.0	79.0	7.90
A5205/16	5/16	7.94	0.3125	37.0	79.0	7.94
A5208.0	–	8.00	0.3150	37.0	79.0	8.00
A5208.1	–	8.10	0.3189	37.0	79.0	8.10
A5208.2	–	8.20	0.3228	37.0	79.0	8.20
A5208.3	–	8.30	0.3268	37.0	79.0	8.30
A52021/64	21/64	8.33	0.3281	37.0	79.0	8.33
A5208.4	–	8.40	0.3307	37.0	79.0	8.40
A5208.5	–	8.50	0.3346	37.0	79.0	8.50
A5208.6	–	8.60	0.3386	40.0	84.0	8.60
A5208.7	–	8.70	0.3425	40.0	84.0	8.70
A52011/32	11/32	8.73	0.3438	40.0	84.0	8.73
A5208.8	–	8.80	0.3465	40.0	84.0	8.80
A5208.9	–	8.90	0.3504	40.0	84.0	8.90
A5209.0	–	9.00	0.3543	40.0	84.0	9.00
A5209.1	–	9.10	0.3583	40.0	84.0	9.10
A52023/64	23/64	9.13	0.3594	40.0	84.0	9.13
A5209.2	–	9.20	0.3622	40.0	84.0	9.20
A5209.3	–	9.30	0.3661	40.0	84.0	9.30
A5209.4	–	9.40	0.3701	40.0	84.0	9.40
A5209.5	–	9.50	0.3740	40.0	84.0	9.50
A5203/8	3/8	9.52	0.3750	43.0	89.0	9.52
A5209.6	–	9.60	0.3780	43.0	89.0	9.60
A5209.7	–	9.70	0.3819	43.0	89.0	9.70
A5209.8	–	9.80	0.3858	43.0	89.0	9.80
A5209.9	–	9.90	0.3898	43.0	89.0	9.90

Produkt	DC	DC	DC	LCF	OAL	D CON MS
	(inch)	(mm)	(inch)	(mm)	(mm)	(mm)
A52025/64	25/64	9.92	0.3906	43.0	89.0	9.92
A52010.0	–	10.00	0.3937	43.0	89.0	10.00
A52010.1	–	10.10	0.3976	43.0	89.0	10.10
A52010.2	–	10.20	0.4016	43.0	89.0	10.20
A52010.3	–	10.30	0.4055	43.0	89.0	10.30
A52013/32	13/32	10.32	0.4063	43.0	89.0	10.32
A52010.4	–	10.40	0.4094	43.0	89.0	10.40
A52010.5	–	10.50	0.4134	43.0	89.0	10.50
A52010.6	–	10.60	0.4173	43.0	89.0	10.60
A52010.7	–	10.70	0.4213	47.0	95.0	10.70
A52027/64	27/64	10.72	0.4219	47.0	95.0	10.72
A52010.8	–	10.80	0.4252	47.0	95.0	10.80
A52010.9	–	10.90	0.4291	47.0	95.0	10.90
A52011.0	–	11.00	0.4331	47.0	95.0	11.00
A52011.1	–	11.10	0.4370	47.0	95.0	11.10
A5207/16	7/16	11.11	0.4375	47.0	95.0	11.11
A52011.2	–	11.20	0.4409	47.0	95.0	11.20
A52011.3	–	11.30	0.4449	47.0	95.0	11.30
A52011.4	–	11.40	0.4488	47.0	95.0	11.40
A52011.5	–	11.50	0.4528	47.0	95.0	11.50
A52029/64	29/64	11.51	0.4531	47.0	95.0	11.51
A52011.6	–	11.60	0.4567	47.0	95.0	11.60
A52011.7	–	11.70	0.4606	47.0	95.0	11.70
A52011.8	–	11.80	0.4646	47.0	95.0	11.80
A52011.9	–	11.90	0.4685	51.0	102.0	11.90
A52015/32	15/32	11.91	0.4688	51.0	102.0	11.91
A52012.0	–	12.00	0.4724	51.0	102.0	12.00
A52012.1	–	12.10	0.4764	51.0	102.0	12.10
A52012.2	–	12.20	0.4803	51.0	102.0	12.20
A52012.3	–	12.30	0.4843	51.0	102.0	12.30
A52031/64	31/64	12.30	0.4844	51.0	102.0	12.30
A52012.4	–	12.40	0.4882	51.0	102.0	12.40
A52012.5	–	12.50	0.4921	51.0	102.0	12.50
A52012.6	–	12.60	0.4961	51.0	102.0	12.60
A52012.7	–	12.70	0.5000	51.0	102.0	12.70
A5201/2	1/2	12.70	0.5000	51.0	102.0	12.70
A52012.8	–	12.80	0.5039	51.0	102.0	12.80
A52012.9	–	12.90	0.5079	51.0	102.0	12.90
A52013.0	–	13.00	0.5118	51.0	102.0	13.00



A124



HSS Navrtávák s naletovanou karbidovou špičkou, Parní temperace povrchu

Napájená karbidová špička dodává vysoký výkon nástroje, pevné a méně křehké tělo vrtáku je zároveň ekonomickým řešením. Vrcholový úhel 118° a konstrukce se 4 fazetkami napomáhá vystředění. Lze použít na CNC i konvenčních strojích. Parní temperace povrchu zadržuje řeznou kapalinu.

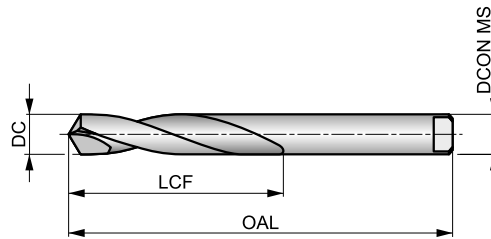

HSS HM	DIN 8037	2.5×D
118°	Bright ST	
λ 10-20°		

Skupiny obráběných materiálů, startovní řezná rychlost (Vc m/min) a kód posuvu. Tabulku s posuvem na otáčku naleznete od strany 175.

P2.3 ■ 40 C	P3.3 ■ 40 C	P4.2 ■ 30 C	P4.3 ■ 24 A	M3.1 ■ 41 C	M3.2 ■ 35 C	M3.3 ■ 32 C	M4.1 ■ 35 C	K1.1 ■ 55 C	K1.2 ■ 41 C	K1.3 ■ 31 C	K2.1 ■ 49 C	K2.2 ■ 40 C	K2.3 ■ 32 A
K3.1 ■ 44 C	K3.2 ■ 33 C	K3.3 ■ 27 A	K4.1 ■ 40 C	K4.2 ■ 30 C	K4.3 ■ 22 A	K4.4 ■ 19 A	K4.5 ■ 16 A	K5.1 ■ 46 C	K5.2 ■ 34 C	K5.3 ■ 27 A	N3.1 ■ 119 E	N3.2 ■ 170 G	N4.2 ■ 60 E
S1.1 ■ 40 A	S1.2 ■ 35 A	S1.3 ■ 25 A	S2.1 ■ 33 A	S2.2 ■ 28 A	S3.1 ■ 25 A	S3.2 ■ 20 A	S4.1 ■ 20 A	S4.2 ■ 16 A					

Hrot dle DIN 1809.

Produkt	DC	DC	LCF	OAL	DCON MS
	(mm)	(inch)			
A1243.0	3.00	0.1181	20.0	50.0	3.00
A1243.2	3.20	0.1260	25.0	56.0	3.20
A1243.5	3.50	0.1378	25.0	56.0	3.50
A1244.0	4.00	0.1575	25.0	56.0	4.00
A1244.2	4.20	0.1654	28.0	63.0	4.20
A1244.5	4.50	0.1772	28.0	63.0	4.50
A1244.8	4.80	0.1890	28.0	63.0	4.80
A1245.0	5.00	0.1969	28.0	63.0	5.00
A1245.2	5.20	0.2047	32.0	71.0	5.20
A1245.5	5.50	0.2165	32.0	71.0	5.50
A1245.8	5.80	0.2283	32.0	71.0	5.80
A1246.0	6.00	0.2362	32.0	71.0	6.00
A1246.5	6.50	0.2559	32.0	71.0	6.50
A1246.8	6.80	0.2677	40.0	80.0	6.80
A1247.0	7.00	0.2756	40.0	80.0	7.00

Produkt	DC	DC	LCF	OAL	DCON MS
	(mm)	(inch)			
A1247.5	7.50	0.2953	40.0	80.0	7.50
A1248.0	8.00	0.3150	40.0	80.0	8.00
A1248.5	8.50	0.3346	50.0	90.0	8.50
A1249.0	9.00	0.3543	50.0	90.0	9.00
A1249.5	9.50	0.3740	50.0	90.0	9.50
A12410.0	10.00	0.3937	56.0	100.0	10.00
A12410.5	10.50	0.4134	56.0	100.0	10.50
A12411.0	11.00	0.4331	56.0	100.0	11.00
A12411.5	11.50	0.4528	63.0	112.0	11.50
A12412.0	12.00	0.4724	63.0	112.0	12.00
A12413.0	13.00	0.5118	63.0	112.0	13.00
A12414.0	14.00	0.5512	71.0	125.0	14.00
A12415.0	15.00	0.5906	71.0	125.0	15.00
A12416.0	16.00	0.6299	80.0	140.0	16.00



A720



HSS-E (5 % kobaltu) Mikrovrták, Leštěný

Mikrovrták velmi malých průměrů od 0.15 mm do 1.40 mm. Pro snazší upnutí mají všechny vrtáky průměr stopky 1.00 mm nebo 1.50 mm. Vrcholový úhel 118° a 4-fazetková konstrukce napomáhá vystředění a snižuje rezné síly.

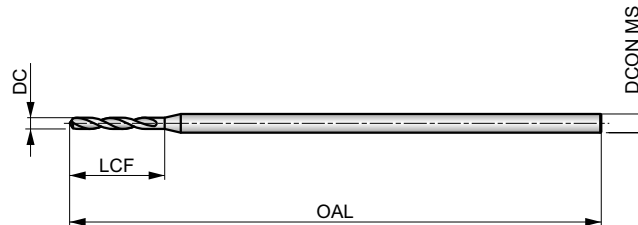

HSS-E	DIN 1899	2.5×D
118°	Bright	
λ 20-35°	R	

Skupiny obráběných materiálů, startovní řezná rychlost (Vc m/min) a kód posuvu. Tabulku s posuvem na otáčku naleznete od strany 175.

P1.1 ■ 36 A	P1.2 ■ 40 A	P1.3 ■ 41 A	P2.1 ■ 31 A	P2.2 ■ 27 A	P2.3 ■ 24 A	P3.1 ■ 25 A	P3.2 ■ 20 A	P3.3 ■ 17 A	P4.1 ■ 15 A	P4.2 ■ 13 A	P4.3 ■ 10 A	M1.1 ■ 30 A	M1.2 ■ 26 A
M2.1 ■ 27 A	M2.2 ■ 22 A	M3.1 ■ 12 A	M3.2 ■ 10 A	M3.3 ■ 9 A	M4.1 ■ 15 A	K1.1 ■ 30 A	K1.2 ■ 22 A	K1.3 ■ 17 A	K2.1 ■ 25 A	K2.2 ■ 20 A	K2.3 ■ 16 A	K3.1 ■ 22 A	K3.2 ■ 17 A
K3.3 ■ 13 A	K4.1 ■ 20 A	K4.2 ■ 15 A	K4.3 ■ 11 A	K4.4 ■ 10 A	K4.5 ■ 8 A	K5.1 ■ 23 A	K5.2 ■ 17 A	K5.3 ■ 13 A	N1.1 ■ 35 A	N1.2 ■ 26 A	N1.3 ■ 18 A	N2.1 ■ 42 A	N2.2 ■ 37 A
N2.3 ■ 27 A	N3.1 ■ 68 A	N3.2 ■ 40 A	N3.3 ■ 20 A	N4.1 ■ 48 A	N4.2 ■ 25 A	S1.1 ■ 23 A	S1.2 ■ 17 A	S1.3 ■ 8 A	S2.1 ■ 9 A	S2.2 ■ 6 A	S3.1 ■ 7 A	S3.2 ■ 4 A	S4.1 ■ 5 A
S4.2 ■ 3 A													

Produkt	DC	DC	LCF	OAL	DCON MS	Produkt	DC	DC	LCF	OAL	DCON MS
	(mm)	(inch)					(mm)	(mm)			
A720.15	0.15	0.0059	1.0	25.0	1.00	A720.55	0.55	0.0217	4.5	25.0	1.00
A720.16	0.16	0.0063	1.4	25.0	1.00	A720.6	0.60	0.0236	4.5	25.0	1.00
A720.17	0.17	0.0067	1.4	25.0	1.00	A720.62	0.62	0.0244	5.0	25.0	1.00
A720.18	0.18	0.0070	1.4	25.0	1.00	A720.65	0.65	0.0256	5.0	25.0	1.00
A720.2	0.20	0.0079	1.8	25.0	1.00	A720.7	0.70	0.0276	5.6	25.0	1.00
A720.22	0.22	0.0087	1.8	25.0	1.00	A720.75	0.75	0.0295	5.6	25.0	1.00
A720.25	0.25	0.0098	2.2	25.0	1.00	A720.8	0.80	0.0315	6.3	25.0	1.50
A720.27	0.27	0.0106	2.2	25.0	1.00	A720.85	0.85	0.0335	6.3	25.0	1.50
A720.28	0.28	0.0110	2.2	25.0	1.00	A720.9	0.90	0.0354	7.1	25.0	1.50
A720.3	0.30	0.0118	2.2	25.0	1.00	A720.95	0.95	0.0374	7.1	25.0	1.50
A720.35	0.35	0.0138	2.8	25.0	1.00	A7201.0	1.00	0.0394	8.0	25.0	1.50
A720.38	0.38	0.0150	2.8	25.0	1.00	A7201.05	1.05	0.0413	8.0	25.0	1.50
A720.39	0.39	0.0154	3.6	25.0	1.00	A7201.1	1.10	0.0433	9.0	25.0	1.50
A720.4	0.40	0.0157	3.6	25.0	1.00	A7201.2	1.20	0.0472	10.0	25.0	1.50
A720.45	0.45	0.0177	3.6	25.0	1.00	A7201.3	1.30	0.0512	10.0	25.0	1.50
A720.5	0.50	0.0197	4.0	25.0	1.00	A7201.4	1.40	0.0551	11.2	25.0	1.50



A920



PFX HSS-E (5 % kobaltu) Vrták krátký, Leštěný

Produktivní vrták pro kvalitní a přesné otvory, vhodný pro vysoké řezné rychlosti a velké posuvy (tolerance otvorů H10). Vrcholový úhel 130° a speciální parabolická drážka usnadňuje vrtání hlubokých otvorů v jednom kroku. Vhodný pro širokou oblast obráběných materiálů.

PFX

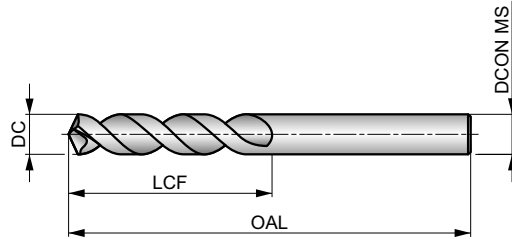

HSS-E	DIN ANSI	3×D
130°	Bright	
λ > 35°	R	DC h8

Skupiny obráběných materiálů, startovní řezná rychlost (Vc m/min) a kód posuvu. Tabulku s posuvem na otáčku naleznete od strany 175.

P1.1 ■ 42 J	P1.2 ■ 47 J	P1.3 ■ 49 J	P2.1 ■ 36 J	P2.2 ■ 32 I	P2.3 ■ 28 E	P3.1 ■ 34 I	P3.2 ■ 27 I	P3.3 ■ 23 E	P4.1 ■ 20 I	P4.2 ■ 17 E	P4.3 ■ 14 E	M1.1 ■ 21 F	M1.2 ■ 17 F
M2.1 ■ 18 F	M2.2 ■ 15 F	M3.1 ■ 8 F	M3.2 ■ 7 F	M3.3 ■ 6 F	M4.1 ■ 9 D	K1.1 ■ 34 L	K1.2 ■ 25 L	K1.3 ■ 19 L	K2.1 ■ 32 L	K2.2 ■ 26 L	K2.3 ■ 21 J	K3.1 ■ 28 L	K3.2 ■ 22 L
K3.3 ■ 17 J	K4.1 ■ 26 L	K4.2 ■ 20 L	K4.3 ■ 14 J	K4.4 ■ 12 J	K4.5 ■ 10 J	K5.1 ■ 30 L	K5.2 ■ 22 L	K5.3 ■ 17 J	N1.1 ■ 75 L	N1.2 ■ 56 L	N1.3 ■ 38 N	N2.1 ■ 62 N	N2.2 ■ 55 N
N2.3 ■ 40 N	N3.1 ■ 112 J	N3.2 ■ 66 J	N3.3 ■ 33 H	N4.1 ■ 55 J	N4.2 ■ 40 H	S1.1 ■ 30 G	S1.2 ■ 18 G	S1.3 ■ 10 C	S2.1 ■ 12 G	S2.2 ■ 8 E	S3.1 ■ 9 G	S3.2 ■ 6 E	S4.1 ■ 7 G
S4.2 ■ 5 E													

Produkt	DC	DC	DC	LCF	OAL	DCON MS
	(inch)	(mm)	(inch)	(mm)	(mm)	(mm)
A9201.0	–	1.00	0.0394	6.0	26.0	1.00
A9201.1	–	1.10	0.0433	7.0	28.0	1.10
A9203/64	3/64	1.19	0.0469	13.0	35.0	1.19
A9201.2	–	1.20	0.0472	8.0	30.0	1.20
A9201.25	–	1.25	0.0492	8.0	30.0	1.25
A9201.3	–	1.30	0.0512	8.0	30.0	1.30
A9201.35	–	1.35	0.0531	9.0	32.0	1.35
A9201.4	–	1.40	0.0551	9.0	32.0	1.40
A9201.5	–	1.50	0.0591	9.0	32.0	1.50
A9201.55	–	1.55	0.0610	10.0	34.0	1.55
A9201/16	1/16	1.59	0.0625	16.0	41.0	1.59
A9201.6	–	1.60	0.0630	10.0	34.0	1.60
A9201.7	–	1.70	0.0669	10.0	34.0	1.70
A9201.75	–	1.75	0.0689	11.0	36.0	1.75
A9201.8	–	1.80	0.0709	11.0	36.0	1.80
A9201.9	–	1.90	0.0748	11.0	36.0	1.90
A9205/64	5/64	1.98	0.0781	17.0	43.0	1.98
A9202.0	–	2.00	0.0787	12.0	38.0	2.00
A9202.1	–	2.10	0.0827	12.0	38.0	2.10
A9202.15	–	2.15	0.0846	13.0	40.0	2.15
A9202.2	–	2.20	0.0866	13.0	40.0	2.20
A9202.3	–	2.30	0.0906	13.0	40.0	2.30
A9202.35	–	2.35	0.0925	14.0	43.0	2.35
A9203/32	3/32	2.38	0.0938	19.0	41.0	2.38

Produkt	DC	DC	DC	LCF	OAL	DCON MS
	(inch)	(mm)	(inch)	(mm)	(mm)	(mm)
A9202.4	–	2.40	0.0945	14.0	43.0	2.40
A9202.5	–	2.50	0.0984	14.0	43.0	2.50
A9202.6	–	2.60	0.1024	14.0	43.0	2.60
A9202.7	–	2.70	0.1063	16.0	46.0	2.70
A9207/64	7/64	2.78	0.1094	21.0	46.0	2.78
A9202.8	–	2.80	0.1102	16.0	46.0	2.80
A9202.9	–	2.90	0.1142	16.0	46.0	2.90
A9203.0	–	3.00	0.1181	16.0	46.0	3.00
A9203.1	–	3.10	0.1220	18.0	49.0	3.10
A9201/8	1/8	3.18	0.1250	22.0	48.0	3.18
A9203.2	–	3.20	0.1260	18.0	49.0	3.20
A9203.3	–	3.30	0.1299	18.0	49.0	3.30
A9203.4	–	3.40	0.1339	20.0	52.0	3.40
A9203.5	–	3.50	0.1378	20.0	52.0	3.50
A9209/64	9/64	3.57	0.1406	24.0	49.0	3.57
A9203.6	–	3.60	0.1417	20.0	52.0	3.60
A9203.7	–	3.70	0.1457	20.0	52.0	3.70
A9203.8	–	3.80	0.1496	22.0	55.0	3.80
A9203.9	–	3.90	0.1535	22.0	55.0	3.90
A9205/32	5/32	3.97	0.1563	25.0	52.0	3.97
A9204.0	–	4.00	0.1575	22.0	55.0	4.00
A9204.1	–	4.10	0.1614	22.0	55.0	4.10
A9204.2	–	4.20	0.1654	22.0	55.0	4.20
A9204.3	–	4.30	0.1693	24.0	58.0	4.30



Produkt	DC	DC	DC	LCF	OAL	DCON MS
	(inch)	(mm)	(inch)	(mm)	(mm)	(mm)
A92011/64	11/64	4.37	0.1719	27.0	54.0	4.37
A9204.4	–	4.40	0.1732	24.0	58.0	4.40
A9204.5	–	4.50	0.1772	24.0	58.0	4.50
A9204.6	–	4.60	0.1811	24.0	58.0	4.60
A9204.7	–	4.70	0.1850	24.0	58.0	4.70
A9203/16	3/16	4.76	0.1875	29.0	56.0	4.76
A9204.8	–	4.80	0.1890	26.0	62.0	4.80
A9204.9	–	4.90	0.1929	26.0	62.0	4.90
A9205.0	–	5.00	0.1969	26.0	62.0	5.00
A9205.1	–	5.10	0.2008	26.0	62.0	5.10
A92013/64	13/64	5.16	0.2031	30.0	57.0	5.16
A9205.2	–	5.20	0.2047	26.0	62.0	5.20
A9205.3	–	5.30	0.2087	26.0	62.0	5.30
A9205.4	–	5.40	0.2126	28.0	66.0	5.40
A9205.5	–	5.50	0.2165	28.0	66.0	5.50
A9207/32	7/32	5.56	0.2188	32.0	60.0	5.56
A9205.6	–	5.60	0.2205	28.0	66.0	5.60
A9205.7	–	5.70	0.2244	28.0	66.0	5.70
A9205.8	–	5.80	0.2283	28.0	66.0	5.80
A9205.9	–	5.90	0.2323	28.0	66.0	5.90
A92015/64	15/64	5.95	0.2344	33.0	62.0	5.95
A9206.0	–	6.00	0.2362	28.0	66.0	6.00
A9206.1	–	6.10	0.2402	31.0	70.0	6.10
A9206.2	–	6.20	0.2441	31.0	70.0	6.20
A9206.3	–	6.30	0.2480	31.0	70.0	6.30
A9201/4	1/4	6.35	0.2500	35.0	64.0	6.35
A9206.4	–	6.40	0.2520	31.0	70.0	6.40
A9206.5	–	6.50	0.2559	31.0	70.0	6.50
A9206.6	–	6.60	0.2598	31.0	70.0	6.60
A9206.7	–	6.70	0.2638	31.0	70.0	6.70
A92017/64	17/64	6.75	0.2656	37.0	67.0	6.75
A9206.8	–	6.80	0.2677	34.0	74.0	6.80
A9206.9	–	6.90	0.2717	34.0	74.0	6.90
A9207.0	–	7.00	0.2756	34.0	74.0	7.00
A9207.1	–	7.10	0.2795	34.0	74.0	7.10
A9209/32	9/32	7.14	0.2813	38.0	68.0	7.14
A9207.2	–	7.20	0.2835	34.0	74.0	7.20
A9207.3	–	7.30	0.2874	34.0	74.0	7.30
A9207.4	–	7.40	0.2913	34.0	74.0	7.40
A9207.5	–	7.50	0.2953	34.0	74.0	7.50
A92019/64	19/64	7.54	0.2969	40.0	70.0	7.54
A9207.6	–	7.60	0.2992	37.0	79.0	7.60
A9207.7	–	7.70	0.3031	37.0	79.0	7.70
A9207.8	–	7.80	0.3071	37.0	79.0	7.80
A9207.9	–	7.90	0.3110	37.0	79.0	7.90
A9205/16	5/16	7.94	0.3125	41.0	71.0	7.94
A9208.0	–	8.00	0.3150	37.0	79.0	8.00
A9208.1	–	8.10	0.3189	37.0	79.0	8.10
A9208.2	–	8.20	0.3228	37.0	79.0	8.20
A9208.3	–	8.30	0.3268	37.0	79.0	8.30
A92021/64	21/64	8.33	0.3281	43.0	75.0	8.33
A9208.4	–	8.40	0.3307	37.0	79.0	8.40
A9208.5	–	8.50	0.3346	37.0	79.0	8.50
A9208.6	–	8.60	0.3386	40.0	84.0	8.60
A9208.7	–	8.70	0.3425	40.0	84.0	8.70
A92011/32	11/32	8.73	0.3438	43.0	76.0	8.73
A9208.8	–	8.80	0.3465	40.0	84.0	8.80
A9208.9	–	8.90	0.3504	40.0	84.0	8.90
A9209.0	–	9.00	0.3543	40.0	84.0	9.00
A9209.1	–	9.10	0.3583	40.0	84.0	9.10
A92023/64	23/64	9.13	0.3594	44.0	78.0	9.13
A9209.2	–	9.20	0.3622	40.0	84.0	9.20

Produkt	DC	DC	DC	LCF	OAL	DCON MS
	(inch)	(mm)	(inch)	(mm)	(mm)	(mm)
A9209.3	–	9.30	0.3661	40.0	84.0	9.30
A9209.4	–	9.40	0.3701	40.0	84.0	9.40
A9209.5	–	9.50	0.3740	40.0	84.0	9.50
A9203/8	3/8	9.52	0.3750	46.0	79.0	9.52
A9209.6	–	9.60	0.3780	43.0	89.0	9.60
A9209.7	–	9.70	0.3819	43.0	89.0	9.70
A9209.8	–	9.80	0.3858	43.0	89.0	9.80
A9209.9	–	9.90	0.3898	43.0	89.0	9.90
A92025/64	25/64	9.92	0.3906	48.0	83.0	9.92
A92010.0	–	10.00	0.3937	43.0	89.0	10.00
A92010.2	–	10.20	0.4016	43.0	89.0	10.20
A92010.3	–	10.30	0.4055	43.0	89.0	10.30
A92013/32	13/32	10.32	0.4063	49.0	84.0	10.32
A92010.5	–	10.50	0.4134	43.0	89.0	10.50
A92027/64	27/64	10.72	0.4219	51.0	86.0	10.72
A92010.8	–	10.80	0.4252	47.0	95.0	10.80
A92011.0	–	11.00	0.4331	47.0	95.0	11.00
A9207/16	7/16	11.11	0.4375	52.0	87.0	11.11
A92011.5	–	11.50	0.4528	47.0	95.0	11.50
A92029/64	29/64	11.51	0.4531	54.0	90.0	11.51
A92011.8	–	11.80	0.4646	47.0	95.0	11.80
A92015/32	15/32	11.91	0.4688	54.0	92.0	11.91
A92012.0	–	12.00	0.4724	51.0	102.0	12.00
A92012.2	–	12.20	0.4803	51.0	102.0	12.20
A92031/64	31/64	12.30	0.4844	56.0	94.0	12.30
A92012.5	–	12.50	0.4921	51.0	102.0	12.50
A9201/2	1/2	12.70	0.5000	57.0	95.0	12.70
A92013.0	–	13.00	0.5118	51.0	102.0	13.00
A92033/64	33/64	13.10	0.5156	60.0	98.0	13.10
A92013.5	–	13.50	0.5315	54.0	107.0	13.50
A92035/64	35/64	13.89	0.5469	64.0	102.0	13.89
A92014.0	–	14.00	0.5512	54.0	107.0	14.00
A9209/16	9/16	14.29	0.5625	64.0	102.0	14.29
A92014.5	–	14.50	0.5709	56.0	111.0	14.50
A92037/64	37/64	14.68	0.5781	67.0	105.0	14.68
A92014.75	–	14.75	0.5807	56.0	111.0	14.75
A92015.0	–	15.00	0.5906	56.0	111.0	15.00
A92019/32	19/32	15.08	0.5938	67.0	105.0	15.08
A92039/64	39/64	15.48	0.6094	70.0	108.0	15.48
A92015.5	–	15.50	0.6102	58.0	115.0	15.50
A9205/8	5/8	15.88	0.6250	70.0	108.0	15.88
A92016.0	–	16.00	0.6299	58.0	115.0	16.00
A92041/64	41/64	16.27	0.6406	73.0	114.0	16.27
A92016.5	–	16.50	0.6496	60.0	119.0	16.50
A92021/32	21/32	16.67	0.6563	73.0	114.0	16.67
A92016.75	–	16.75	0.6594	60.0	119.0	16.75
A92017.0	–	17.00	0.6693	60.0	119.0	17.00
A92043/64	43/64	17.07	0.6719	73.0	117.0	17.07
A92011/16	11/16	17.46	0.6875	73.0	117.0	17.46
A92017.5	–	17.50	0.6890	62.0	123.0	17.50
A92045/64	45/64	17.86	0.7031	76.0	121.0	17.86
A92018.0	–	18.00	0.7087	62.0	123.0	18.00
A92023/32	23/32	18.26	0.7188	76.0	121.0	18.26
A92018.5	–	18.50	0.7283	64.0	127.0	18.50
A92047/64	47/64	18.65	0.7344	79.0	127.0	18.65
A92019.0	–	19.00	0.7480	64.0	127.0	19.00
A9203/4	3/4	19.05	0.7500	79.0	127.0	19.05
A92049/64	49/64	19.45	0.7656	83.0	130.0	19.45
A92019.5	–	19.50	0.7677	66.0	131.0	19.50
A92025/32	25/32	19.84	0.7813	83.0	130.0	19.84
A92020.0	–	20.00	0.7874	66.0	131.0	20.00



A921



PFX HSS-E (5 % kobaltu) Vrták krátký, Povlak Alcrona

Produktivní vrták pro kvalitní a přesné otvory, vhodný pro vysoké rezní rychlosti a velké posuvy (tolerance otvorů H10). Vrcholový úhel 130° a speciální parabolická drážka usnadňuje vrtání hlubokých otvorů v jednom kroku. Vhodný pro širokou oblast obráběných materiálů. Povlak Alcrona zvyšuje produktivitu a prodlužuje životnost.

PFX

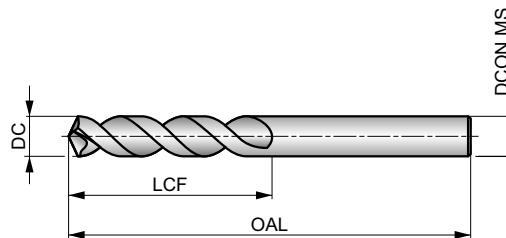

HSS-E	DIN ANSI	3×D
130°		
		DC h8

Skupiny obráběných materiálů, startovní řezná rychlost (Vc m/min) a kód posuvu. Tabulku s posuvem na otáčku naleznete od strany 175.

P1.1 ■ 70 M	P1.2 ■ 79 M	P1.3 ■ 81 M	P2.1 ■ 60 M	P2.2 ■ 53 J	P2.3 ■ 47 G	P3.1 ■ 56 J	P3.2 ■ 45 J	P3.3 ■ 38 G	P4.1 ■ 33 J	P4.2 ■ 28 G	P4.3 ■ 23 G	M1.1 ■ 23 F	M1.2 ■ 20 F
M2.1 ■ 21 F	M2.2 ■ 17 F	M3.1 ■ 10 F	M3.2 ■ 9 F	M3.3 ■ 8 F	M4.1 ■ 11 D	K1.1 ■ 53 L	K1.2 ■ 39 L	K1.3 ■ 29 L	K2.1 ■ 52 L	K2.2 ■ 42 L	K2.3 ■ 33 J	K3.1 ■ 46 L	K3.2 ■ 35 L
K3.3 ■ 28 J	K4.1 ■ 42 L	K4.2 ■ 32 L	K4.3 ■ 23 J	K4.4 ■ 20 J	K4.5 ■ 17 J	K5.1 ■ 48 L	K5.2 ■ 36 L	K5.3 ■ 28 J	S1.1 ■ 48 I	S1.2 ■ 29 I	S1.3 ■ 16 E	S2.1 ■ 19 I	S2.2 ■ 14 G
S3.1 ■ 14 I	S3.2 ■ 10 G	S4.1 ■ 11 I	S4.2 ■ 8 G										

Produkt	DC	DC	DC	LCF	OAL	DCON MS
	(inch)	(mm)	(inch)	(mm)	(mm)	(mm)
A9212.5	–	2.50	0.0984	14.0	43.0	2.50
A9212.6	–	2.60	0.1024	14.0	43.0	2.60
A9212.7	–	2.70	0.1063	16.0	46.0	2.70
A9217/64	7/64	2.78	0.1094	21.0	46.0	2.78
A9212.9	–	2.90	0.1142	16.0	46.0	2.90
A9213.0	–	3.00	0.1181	16.0	46.0	3.00
A9213.1	–	3.10	0.1220	18.0	49.0	3.10
A9211/8	1/8	3.18	0.1250	22.0	48.0	3.18
A9213.2	–	3.20	0.1260	18.0	49.0	3.20
A9213.3	–	3.30	0.1299	18.0	49.0	3.30
A9213.4	–	3.40	0.1339	20.0	52.0	3.40
A9213.5	–	3.50	0.1378	20.0	52.0	3.50
A9219/64	9/64	3.57	0.1406	24.0	49.0	3.57
A9213.6	–	3.60	0.1417	20.0	52.0	3.60
A9213.7	–	3.70	0.1457	20.0	52.0	3.70
A9213.8	–	3.80	0.1496	22.0	55.0	3.80
A9213.9	–	3.90	0.1535	22.0	55.0	3.90
A9215/32	5/32	3.97	0.1563	25.0	52.0	3.97
A9214.0	–	4.00	0.1575	22.0	55.0	4.00
A9214.1	–	4.10	0.1614	22.0	55.0	4.10
A9214.2	–	4.20	0.1654	22.0	55.0	4.20
A9214.3	–	4.30	0.1693	24.0	58.0	4.30
A92111/64	11/64	4.37	0.1719	27.0	54.0	4.37
A9214.4	–	4.40	0.1732	24.0	58.0	4.40
A9214.5	–	4.50	0.1772	24.0	58.0	4.50
A9214.6	–	4.60	0.1811	24.0	58.0	4.60

Produkt	DC	DC	DC	LCF	OAL	DCON MS
	(inch)	(mm)	(inch)	(mm)	(mm)	(mm)
A9214.7	–	4.70	0.1850	24.0	58.0	4.70
A9213/16	3/16	4.76	0.1875	29.0	56.0	4.76
A9214.8	–	4.80	0.1890	26.0	62.0	4.80
A9214.9	–	4.90	0.1929	26.0	62.0	4.90
A9215.0	–	5.00	0.1969	26.0	62.0	5.00
A9215.1	–	5.10	0.2008	26.0	62.0	5.10
A92113/64	13/64	5.16	0.2031	30.0	57.0	5.16
A9215.2	–	5.20	0.2047	26.0	62.0	5.20
A9215.3	–	5.30	0.2087	26.0	62.0	5.30
A9215.4	–	5.40	0.2126	28.0	66.0	5.40
A9215.5	–	5.50	0.2165	28.0	66.0	5.50
A9217/32	7/32	5.56	0.2188	32.0	60.0	5.56
A9215.6	–	5.60	0.2205	28.0	66.0	5.60
A9215.7	–	5.70	0.2244	28.0	66.0	5.70
A9215.8	–	5.80	0.2283	28.0	66.0	5.80
A9215.9	–	5.90	0.2323	28.0	66.0	5.90
A92115/64	15/64	5.95	0.2344	33.0	62.0	5.95
A9216.0	–	6.00	0.2362	28.0	66.0	6.00
A9216.1	–	6.10	0.2402	31.0	70.0	6.10
A9216.2	–	6.20	0.2441	31.0	70.0	6.20
A9216.3	–	6.30	0.2480	31.0	70.0	6.30
A9211/4	1/4	6.35	0.2500	35.0	64.0	6.35
A9216.4	–	6.40	0.2520	31.0	70.0	6.40
A9216.5	–	6.50	0.2559	31.0	70.0	6.50
A9216.6	–	6.60	0.2598	31.0	70.0	6.60
A9216.7	–	6.70	0.2638	31.0	70.0	6.70



Produkt	DC	DC	DC	LCF	OAL	DCON MS
	(inch)	(mm)	(inch)	(mm)	(mm)	(mm)
A92117/64	17/64	6.75	0.2656	37.0	67.0	6.75
A9216.8	–	6.80	0.2677	34.0	74.0	6.80
A9216.9	–	6.90	0.2717	34.0	74.0	6.90
A9217.0	–	7.00	0.2756	34.0	74.0	7.00
A9217.1	–	7.10	0.2795	34.0	74.0	7.10
A9219/32	9/32	7.14	0.2813	38.0	68.0	7.14
A9217.2	–	7.20	0.2835	34.0	74.0	7.20
A9217.3	–	7.30	0.2874	34.0	74.0	7.30
A9217.4	–	7.40	0.2913	34.0	74.0	7.40
A9217.5	–	7.50	0.2953	34.0	74.0	7.50
A92119/64	19/64	7.54	0.2969	40.0	70.0	7.54
A9217.6	–	7.60	0.2992	37.0	79.0	7.60
A9217.7	–	7.70	0.3031	37.0	79.0	7.70
A9217.8	–	7.80	0.3071	37.0	79.0	7.80
A9217.9	–	7.90	0.3110	37.0	79.0	7.90
A9215/16	5/16	7.94	0.3125	41.0	71.0	7.94
A9218.0	–	8.00	0.3150	37.0	79.0	8.00
A9218.1	–	8.10	0.3189	37.0	79.0	8.10
A9218.2	–	8.20	0.3228	37.0	79.0	8.20
A9218.3	–	8.30	0.3268	37.0	79.0	8.30
A92121/64	21/64	8.33	0.3281	43.0	75.0	8.33
A9218.4	–	8.40	0.3307	37.0	79.0	8.40
A9218.5	–	8.50	0.3346	37.0	79.0	8.50
A9218.6	–	8.60	0.3386	40.0	84.0	8.60
A9218.7	–	8.70	0.3425	40.0	84.0	8.70
A92111/32	11/32	8.73	0.3438	43.0	76.0	8.73
A9218.8	–	8.80	0.3465	40.0	84.0	8.80
A9218.9	–	8.90	0.3504	40.0	84.0	8.90
A9219.0	–	9.00	0.3543	40.0	84.0	9.00
A9219.1	–	9.10	0.3583	40.0	84.0	9.10
A92123/64	23/64	9.13	0.3594	44.0	78.0	9.13
A9219.2	–	9.20	0.3622	40.0	84.0	9.20
A9219.3	–	9.30	0.3661	40.0	84.0	9.30
A9219.4	–	9.40	0.3701	40.0	84.0	9.40
A9219.5	–	9.50	0.3740	40.0	84.0	9.50
A9213/8	3/8	9.52	0.3750	46.0	79.0	9.52
A9219.6	–	9.60	0.3780	43.0	89.0	9.60

Produkt	DC	DC	DC	LCF	OAL	DCON MS
	(inch)	(mm)	(inch)	(mm)	(mm)	(mm)
A9219.7	–	9.70	0.3819	43.0	89.0	9.70
A9219.8	–	9.80	0.3858	43.0	89.0	9.80
A9219.9	–	9.90	0.3898	43.0	89.0	9.90
A92125/64	25/64	9.92	0.3906	48.0	83.0	9.92
A92110.0	–	10.00	0.3937	43.0	89.0	10.00
A92110.2	–	10.20	0.4016	43.0	89.0	10.20
A92110.3	–	10.30	0.4055	43.0	89.0	10.30
A92113/32	13/32	10.32	0.4063	49.0	84.0	10.32
A92110.5	–	10.50	0.4134	43.0	89.0	10.50
A92127/64	27/64	10.72	0.4219	51.0	86.0	10.72
A92110.8	–	10.80	0.4252	47.0	95.0	10.80
A92111.0	–	11.00	0.4331	47.0	95.0	11.00
A9217/16	7/16	11.11	0.4375	52.0	87.0	11.11
A92111.5	–	11.50	0.4528	47.0	95.0	11.50
A92129/64	29/64	11.51	0.4531	54.0	90.0	11.51
A92111.8	–	11.80	0.4646	47.0	95.0	11.80
A92115/32	15/32	11.91	0.4688	54.0	92.0	11.91
A92112.0	–	12.00	0.4724	51.0	102.0	12.00
A92131/64	31/64	12.30	0.4844	56.0	94.0	12.30
A92112.5	–	12.50	0.4921	51.0	102.0	12.50
A9211/2	1/2	12.70	0.5000	57.0	95.0	12.70
A92113.0	–	13.00	0.5118	51.0	102.0	13.00
A92133/64	33/64	13.10	0.5156	60.0	98.0	13.10
A92113.5	–	13.50	0.5315	54.0	107.0	13.50
A92135/64	35/64	13.89	0.5469	64.0	102.0	13.89
A92114.0	–	14.00	0.5512	54.0	107.0	14.00
A9219/16	9/16	14.29	0.5625	64.0	102.0	14.29
A92114.5	–	14.50	0.5709	56.0	111.0	14.50
A92137/64	37/64	14.68	0.5781	67.0	105.0	14.68
A92114.75	–	14.75	0.5807	56.0	111.0	14.75
A92115.0	–	15.00	0.5906	56.0	111.0	15.00
A92119/32	19/32	15.08	0.5938	67.0	105.0	15.08
A92139/64	39/64	15.48	0.6094	70.0	108.0	15.48
A92115.5	–	15.50	0.6102	58.0	115.0	15.50
A9215/8	5/8	15.88	0.6250	70.0	108.0	15.88
A92116.0	–	16.00	0.6299	58.0	115.0	16.00



A002



HSS vrták, Povlakovaný TiN

Univerzální vrták pro strojní i ruční vrtání. Vrcholový úhel 118° a speciální geometrie břitu napomáhá vystředění při ručním vrtání a zpřesňuje otvory. Povlak TiN zvyšuje produktivitu a prodlužuje životnost. Vhodný pro širokou oblast materiálů.

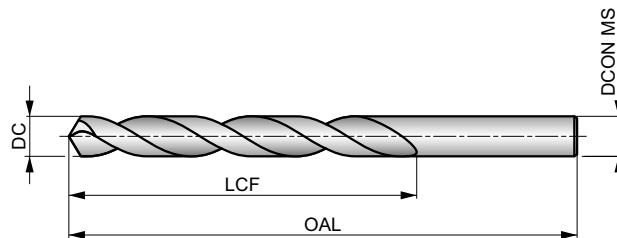

HSS	DIN 338	4xD
118°	TiN-Tip	
λ 20-35°	R	DC h8

Skupiny obráběných materiálů, startovní řezná rychlost (Vc m/min) a kód posuvu. Tabulku s posuvem na otáčku naleznete od strany 175.

P1.1 ■ 46 J	P1.2 ■ 52 J	P1.3 ■ 54 J	P2.1 ■ 40 J	P2.2 ■ 35 F	P2.3 ■ 31 F	P3.1 ■ 27 F	P3.2 ■ 21 F	P3.3 ■ 18 F	P4.1 ■ 16 F	P4.2 ■ 13 F	P4.3 ■ 11 E	M1.1 ■ 27 F	M1.2 ■ 23 F
M2.1 ■ 24 F	M2.2 ■ 20 F	M3.1 ■ 14 G	M3.2 ■ 12 G	M3.3 ■ 11 G	M4.1 ■ 16 C	K1.1 ■ 40 J	K1.2 ■ 30 E	K1.3 ■ 22 E	K2.1 ■ 34 E	K2.2 ■ 28 E	K2.3 ■ 22 E	K3.1 ■ 30 E	K3.2 ■ 23 E
K3.3 ■ 19 E	K4.1 ■ 28 E	K4.2 ■ 21 E	K4.3 ■ 16 E	K4.4 ■ 13 E	K4.5 ■ 11 E	K5.1 ■ 32 E	K5.2 ■ 24 E	K5.3 ■ 19 E	N1.1 ■ 41 K	N1.2 ■ 31 K	N1.3 ■ 21 J	N2.1 ■ 51 I	N2.2 ■ 46 I
N2.3 ■ 33 I	N3.1 ■ 56 H	N3.2 ■ 33 I	N3.3 ■ 17 G	N4.1 ■ 30 I	N4.2 ■ 50 H	N4.3 ■ 35 F	S1.1 ■ 23 F	S1.2 ■ 13 D	S1.3 ■ 7 B	S2.1 ■ 9 E	S2.2 ■ 4 A	S3.1 ■ 7 E	S3.2 ■ 3 A
S4.1 ■ 5 E	S4.2 ■ 2 A												

DC < 2 mm - leštěný; DC >= 2 mm - TiN na hrotu a s příčným ostrím.
Produkty nabízíme i v sadě. Vyhledejte A087, A089, A095 nebo A099.

Produkt	DC (inch)	DC (mm)	DC (inch)	LCF (mm)	OAL (mm)	DCON MS (mm)
A0021.0	—	1.00	0.0394	12.0	34.0	1.00
A0021.1	—	1.10	0.0433	14.0	36.0	1.10
A0023/64	3/64	1.19	0.0469	16.0	38.0	1.19
A0021.2	—	1.20	0.0472	16.0	38.0	1.20
A0021.3	—	1.30	0.0512	16.0	38.0	1.30
A0021.4	—	1.40	0.0551	18.0	40.0	1.40
A0021.5	—	1.50	0.0591	18.0	40.0	1.50
A0021/16	1/16	1.59	0.0625	20.0	43.0	1.59
A0021.6	—	1.60	0.0630	20.0	43.0	1.60
A0021.7	—	1.70	0.0669	20.0	43.0	1.70
A0021.8	—	1.80	0.0709	22.0	46.0	1.80
A0021.9	—	1.90	0.0748	22.0	46.0	1.90
A0025/64	5/64	1.98	0.0781	24.0	49.0	1.98
A0022.0	—	2.00	0.0787	24.0	49.0	2.00
A0022.1	—	2.10	0.0827	24.0	49.0	2.10
A0022.2	—	2.20	0.0866	27.0	53.0	2.20
A0022.3	—	2.30	0.0906	27.0	53.0	2.30
A0023/32	3/32	2.38	0.0938	30.0	57.0	2.38
A0022.4	—	2.40	0.0945	30.0	57.0	2.40
A0022.5	—	2.50	0.0984	30.0	57.0	2.50
A0022.6	—	2.60	0.1024	30.0	57.0	2.60
A0022.7	—	2.70	0.1063	33.0	61.0	2.70
A0027/64	7/64	2.78	0.1094	33.0	61.0	2.78
A0022.8	—	2.80	0.1102	33.0	61.0	2.80

Produkt	DC (inch)	DC (mm)	DC (inch)	LCF (mm)	OAL (mm)	DCON MS (mm)
A0022.9	—	2.90	0.1142	33.0	61.0	2.90
A0023.0	—	3.00	0.1181	33.0	61.0	3.00
A0023.1	—	3.10	0.1220	36.0	65.0	3.10
A0021/8	1/8	3.18	0.1250	36.0	65.0	3.18
A0023.2	—	3.20	0.1260	36.0	65.0	3.20
A0023.25	—	3.25	0.1280	36.0	65.0	3.25
A0023.3	—	3.30	0.1299	36.0	65.0	3.30
A0023.4	—	3.40	0.1339	39.0	70.0	3.40
A0023.5	—	3.50	0.1378	39.0	70.0	3.50
A0029/64	9/64	3.57	0.1406	39.0	70.0	3.57
A0023.6	—	3.60	0.1417	39.0	70.0	3.60
A0023.7	—	3.70	0.1457	39.0	70.0	3.70
A0023.8	—	3.80	0.1496	43.0	75.0	3.80
A0023.9	—	3.90	0.1535	43.0	75.0	3.90
A0025/32	5/32	3.97	0.1563	43.0	75.0	3.97
A0024.0	—	4.00	0.1575	43.0	75.0	4.00
A0024.1	—	4.10	0.1614	43.0	75.0	4.10
A0024.2	—	4.20	0.1654	43.0	75.0	4.20
A0024.3	—	4.30	0.1693	47.0	80.0	4.30
A00211/64	11/64	4.37	0.1719	47.0	80.0	4.37
A0024.4	—	4.40	0.1732	47.0	80.0	4.40
A0024.5	—	4.50	0.1772	47.0	80.0	4.50
A0024.6	—	4.60	0.1811	47.0	80.0	4.60
A0024.7	—	4.70	0.1850	47.0	80.0	4.70



Produkt	DC	DC	DC	LCF	OAL	D CON MS
	(inch)	(mm)	(inch)	(mm)	(mm)	(mm)
A0023/16	3/16	4.76	0.1875	52.0	86.0	4.76
A0024.8	–	4.80	0.1890	52.0	86.0	4.80
A0024.9	–	4.90	0.1929	52.0	86.0	4.90
A0025.0	–	5.00	0.1969	52.0	86.0	5.00
A0025.1	–	5.10	0.2008	52.0	86.0	5.10
A00213/64	13/64	5.16	0.2031	52.0	86.0	5.16
A0025.2	–	5.20	0.2047	52.0	86.0	5.20
A0025.3	–	5.30	0.2087	52.0	86.0	5.30
A0025.4	–	5.40	0.2126	57.0	93.0	5.40
A0025.5	–	5.50	0.2165	57.0	93.0	5.50
A0027/32	7/32	5.56	0.2188	57.0	93.0	5.56
A0025.6	–	5.60	0.2205	57.0	93.0	5.60
A0025.7	–	5.70	0.2244	57.0	93.0	5.70
A0025.8	–	5.80	0.2283	57.0	93.0	5.80
A0025.9	–	5.90	0.2323	57.0	93.0	5.90
A00215/64	15/64	5.95	0.2344	57.0	93.0	5.95
A0026.0	–	6.00	0.2362	57.0	93.0	6.00
A0026.1	–	6.10	0.2402	63.0	101.0	6.10
A0026.2	–	6.20	0.2441	63.0	101.0	6.20
A0026.3	–	6.30	0.2480	63.0	101.0	6.30
A0021/4	1/4	6.35	0.2500	63.0	101.0	6.35
A0026.4	–	6.40	0.2520	63.0	101.0	6.40
A0026.5	–	6.50	0.2559	63.0	101.0	6.50
A0026.6	–	6.60	0.2598	63.0	101.0	6.60
A0026.7	–	6.70	0.2638	63.0	101.0	6.70
A00217/64	17/64	6.75	0.2656	69.0	109.0	6.75
A0026.8	–	6.80	0.2677	69.0	109.0	6.80
A0026.9	–	6.90	0.2717	69.0	109.0	6.90
A0027.0	–	7.00	0.2756	69.0	109.0	7.00
A0027.1	–	7.10	0.2795	69.0	109.0	7.10
A0029/32	9/32	7.14	0.2813	69.0	109.0	7.14
A0027.2	–	7.20	0.2835	69.0	109.0	7.20
A0027.3	–	7.30	0.2874	69.0	109.0	7.30
A0027.4	–	7.40	0.2913	69.0	109.0	7.40
A0027.5	–	7.50	0.2953	69.0	109.0	7.50
A00219/64	19/64	7.54	0.2969	75.0	117.0	7.54
A0027.6	–	7.60	0.2992	75.0	117.0	7.60
A0027.7	–	7.70	0.3031	75.0	117.0	7.70
A0027.8	–	7.80	0.3071	75.0	117.0	7.80
A0027.9	–	7.90	0.3110	75.0	117.0	7.90
A0025/16	5/16	7.94	0.3125	75.0	117.0	7.94
A0028.0	–	8.00	0.3150	75.0	117.0	8.00
A0028.1	–	8.10	0.3189	75.0	117.0	8.10
A0028.2	–	8.20	0.3228	75.0	117.0	8.20
A0028.3	–	8.30	0.3268	75.0	117.0	8.30
A00221/64	21/64	8.33	0.3281	75.0	117.0	8.33
A0028.4	–	8.40	0.3307	75.0	117.0	8.40
A0028.5	–	8.50	0.3346	75.0	117.0	8.50
A0028.6	–	8.60	0.3386	81.0	125.0	8.60
A0028.7	–	8.70	0.3425	81.0	125.0	8.70
A00211/32	11/32	8.73	0.3438	81.0	125.0	8.73
A0028.8	–	8.80	0.3465	81.0	125.0	8.80
A0028.9	–	8.90	0.3504	81.0	125.0	8.90
A0029.0	–	9.00	0.3543	81.0	125.0	9.00
A0029.1	–	9.10	0.3583	81.0	125.0	9.10
A00223/64	23/64	9.13	0.3594	81.0	125.0	9.13
A0029.2	–	9.20	0.3622	81.0	125.0	9.20
A0029.3	–	9.30	0.3661	81.0	125.0	9.30
A0029.4	–	9.40	0.3701	81.0	125.0	9.40
A0029.5	–	9.50	0.3740	81.0	125.0	9.50
A0023/8	3/8	9.52	0.3750	87.0	133.0	9.52
A0029.6	–	9.60	0.3780	87.0	133.0	9.60
A0029.7	–	9.70	0.3819	87.0	133.0	9.70
A0029.8	–	9.80	0.3858	87.0	133.0	9.80
A0029.9	–	9.90	0.3898	87.0	133.0	9.90
A00225/64	25/64	9.92	0.3906	87.0	133.0	9.92
A00210.0	–	10.00	0.3937	87.0	133.0	10.00

Produkt	DC	DC	DC	LCF	OAL	D CON MS
	(inch)	(mm)	(inch)	(mm)	(mm)	(mm)
A00210.1	–	10.10	0.3976	87.0	133.0	10.10
A00210.2	–	10.20	0.4016	87.0	133.0	10.20
A00210.3	–	10.30	0.4055	87.0	133.0	10.30
A00213/32	13/32	10.32	0.4063	87.0	133.0	10.32
A00210.4	–	10.40	0.4094	87.0	133.0	10.40
A00210.5	–	10.50	0.4134	87.0	133.0	10.50
A00210.6	–	10.60	0.4173	87.0	133.0	10.60
A00210.7	–	10.70	0.4213	94.0	142.0	10.70
A00227/64	27/64	10.72	0.4219	94.0	142.0	10.72
A00210.8	–	10.80	0.4252	94.0	142.0	10.80
A00210.9	–	10.90	0.4291	94.0	142.0	10.90
A00211.0	–	11.00	0.4331	94.0	142.0	11.00
A00211.1	–	11.10	0.4370	94.0	142.0	11.10
A0027/16	7/16	11.11	0.4375	94.0	142.0	11.11
A00211.2	–	11.20	0.4409	94.0	142.0	11.20
A00211.3	–	11.30	0.4449	94.0	142.0	11.30
A00211.4	–	11.40	0.4488	94.0	142.0	11.40
A00211.5	–	11.50	0.4528	94.0	142.0	11.50
A00229/64	29/64	11.51	0.4531	94.0	142.0	11.51
A00211.6	–	11.60	0.4567	94.0	142.0	11.60
A00211.7	–	11.70	0.4606	94.0	142.0	11.70
A00211.8	–	11.80	0.4646	94.0	142.0	11.80
A00211.9	–	11.90	0.4685	101.0	151.0	11.90
A00215/32	15/32	11.91	0.4688	101.0	151.0	11.91
A00212.0	–	12.00	0.4724	101.0	151.0	12.00
A00212.1	–	12.10	0.4764	101.0	151.0	12.10
A00212.2	–	12.20	0.4803	101.0	151.0	12.20
A00212.3	–	12.30	0.4843	101.0	151.0	12.30
A00231/64	31/64	12.30	0.4844	101.0	151.0	12.30
A00212.4	–	12.40	0.4882	101.0	151.0	12.40
A00212.5	–	12.50	0.4921	101.0	151.0	12.50
A00212.6	–	12.60	0.4961	101.0	151.0	12.60
A00212.7	–	12.70	0.5000	101.0	151.0	12.70
A0021/2	1/2	12.70	0.5000	101.0	151.0	12.70
A00212.8	–	12.80	0.5039	101.0	151.0	12.80
A00212.9	–	12.90	0.5079	101.0	151.0	12.90
A00213.0	–	13.00	0.5118	101.0	151.0	13.00
A00233/64	33/64	13.10	0.5156	101.0	151.0	13.10
A00213.1	–	13.10	0.5157	101.0	151.0	13.10
A00213.2	–	13.20	0.5197	101.0	151.0	13.20
A00213.25	–	13.25	0.5217	108.0	160.0	13.25
A00213.3	–	13.30	0.5236	108.0	160.0	13.30
A00213.4	–	13.40	0.5276	108.0	160.0	13.40
A00217/32	17/32	13.49	0.5313	108.0	160.0	13.49
A00213.5	–	13.50	0.5315	108.0	160.0	13.50
A00213.6	–	13.60	0.5354	108.0	160.0	13.60
A00213.7	–	13.70	0.5394	108.0	160.0	13.70
A00213.75	–	13.75	0.5413	108.0	160.0	13.75
A00213.8	–	13.80	0.5433	108.0	160.0	13.80
A00235/64	35/64	13.89	0.5469	108.0	160.0	13.89
A00213.9	–	13.90	0.5472	108.0	160.0	13.90
A00214.0	–	14.00	0.5512	108.0	160.0	14.00
A00214.25	–	14.25	0.5610	114.0	169.0	14.25
A0029/16	9/16	14.29	0.5625	114.0	169.0	14.29
A00214.5	–	14.50	0.5709	114.0	169.0	14.50
A00237/64	37/64	14.68	0.5781	114.0	169.0	14.68
A00214.75	–	14.75	0.5807	114.0	169.0	14.75
A00215.0	–	15.00	0.5906	114.0	169.0	15.00
A00219/32	19/32	15.08	0.5938	120.0	178.0	15.08
A00215.25	–	15.25	0.6004	120.0	178.0	15.25
A00239/64	39/64	15.48	0.6094	120.0	178.0	15.48
A00215.5	–	15.50	0.6102	120.0	178.0	15.50
A00215.75	–	15.75	0.6201	120.0	178.0	15.75
A0025/8	5/8	15.88	0.6250	120.0	178.0	15.88
A00216.0	–	16.00	0.6299	120.0	178.0	16.00



A002S



HSS vrták, Povlakovaný TiN

Univerzální vrták pro strojní i ruční vrtání. Vrcholový úhel 118° a speciální geometrie břitu napomáhá vystředění při ručním vrtání a zpřesňuje otvory. Povlak TiN zvyšuje produktivitu a prodlužuje životnost. Vhodný pro širokou oblast materiálů.

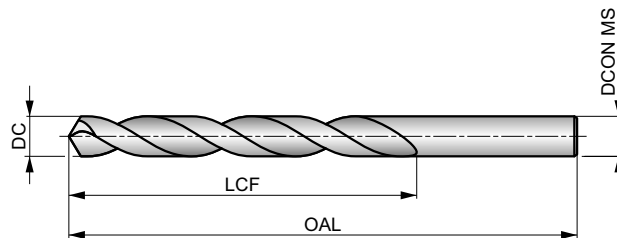

HSS	DIN 338	4xD
118°	TiN-Tip	
λ 20-35°	R	DC h8

Skupiny obráběných materiálů, startovní řezná rychlost (Vc m/min) a kód posuvu. Tabulku s posuvem na otáčku naleznete od strany 175.

P1.1 ■ 46 J	P1.2 ■ 52 J	P1.3 ■ 54 J	P2.1 ■ 40 J	P2.2 ■ 35 F	P2.3 ■ 31 F	P3.1 ■ 27 F	P3.2 ■ 21 F	P3.3 ■ 18 F	P4.1 ■ 16 F	P4.2 ■ 13 F	P4.3 ■ 11 E	M1.1 ■ 27 F	M1.2 ■ 23 F
M2.1 ■ 24 F	M2.2 ■ 20 F	M3.1 ■ 14 G	M3.2 ■ 12 G	M3.3 ■ 11 G	M4.1 ■ 16 C	K1.1 ■ 40 J	K1.2 ■ 30 E	K1.3 ■ 22 E	K2.1 ■ 34 E	K2.2 ■ 28 E	K2.3 ■ 22 E	K3.1 ■ 30 E	K3.2 ■ 23 E
K3.3 ■ 19 E	K4.1 ■ 28 E	K4.2 ■ 21 E	K4.3 ■ 16 E	K4.4 ■ 13 E	K4.5 ■ 11 E	K5.1 ■ 32 E	K5.2 ■ 24 E	K5.3 ■ 19 E	N1.1 ■ 41 K	N1.2 ■ 31 K	N1.3 ■ 21 J	N2.1 ■ 51 I	N2.2 ■ 46 I
N2.3 ■ 33 I	N3.1 ■ 56 H	N3.2 ■ 33 I	N3.3 ■ 17 G	N4.1 ■ 30 I	N4.2 ■ 50 H	N4.3 ■ 35 F	S1.1 ■ 23 F	S1.2 ■ 13 D	S1.3 ■ 7 B	S2.1 ■ 9 E	S2.2 ■ 4 A	S3.1 ■ 7 E	S3.2 ■ 3 A
S4.1 ■ 5 E	S4.2 ■ 2 A												

DC ≤ 5mm prodává se v balení po 2ks.

Produkt	DC	DC	DC	LCF	OAL	DCON MS
	(inch)	(mm)	(inch)	(mm)	(mm)	(mm)
A002S2.0	–	2.00	0.0787	24.0	49.0	2.00
A002S2.5	–	2.50	0.0984	30.0	57.0	2.50
A002S3.0	–	3.00	0.1181	33.0	61.0	3.00
A002S1/8	1/8	3.18	0.1250	36.0	65.0	3.18
A002S3.2	–	3.20	0.1260	36.0	65.0	3.20
A002S3.3	–	3.30	0.1299	36.0	65.0	3.30
A002S3.5	–	3.50	0.1378	39.0	70.0	3.50
A002S5/32	5/32	3.97	0.1563	43.0	75.0	3.97
A002S4.0	–	4.00	0.1575	43.0	75.0	4.00
A002S4.1	–	4.10	0.1614	43.0	75.0	4.10
A002S4.2	–	4.20	0.1654	43.0	75.0	4.20
A002S4.5	–	4.50	0.1772	47.0	80.0	4.50
A002S3/16	3/16	4.76	0.1875	52.0	86.0	4.76
A002S5.0	–	5.00	0.1969	52.0	86.0	5.00
A002S13/64	13/64	5.16	0.2031	52.0	86.0	5.16
A002S5.5	–	5.50	0.2165	57.0	93.0	5.50
A002S7/32	7/32	5.56	0.2188	57.0	93.0	5.56
A002S6.0	–	6.00	0.2362	57.0	93.0	6.00
A002S1/4	1/4	6.35	0.2500	63.0	101.0	6.35
A002S6.5	–	6.50	0.2559	63.0	101.0	6.50

Produkt	DC	DC	DC	LCF	OAL	DCON MS
	(inch)	(mm)	(inch)	(mm)	(mm)	(mm)
A002S17/64	17/64	6.75	0.2656	69.0	109.0	6.75
A002S6.8	–	6.80	0.2677	69.0	109.0	6.80
A002S7.0	–	7.00	0.2756	69.0	109.0	7.00
A002S7.5	–	7.50	0.2953	69.0	109.0	7.50
A002S5/16	5/16	7.94	0.3125	75.0	117.0	7.94
A002S8.0	–	8.00	0.3150	75.0	117.0	8.00
A002S8.2	–	8.20	0.3228	75.0	117.0	8.20
A002S8.5	–	8.50	0.3346	75.0	117.0	8.50
A002S9.0	–	9.00	0.3543	81.0	125.0	9.00
A002S9.5	–	9.50	0.3740	81.0	125.0	9.50
A002S3/8	3/8	9.52	0.3750	87.0	133.0	9.52
A002S10.0	–	10.00	0.3937	87.0	133.0	10.00
A002S10.2	–	10.20	0.4016	87.0	133.0	10.20
A002S10.5	–	10.50	0.4134	87.0	133.0	10.50
A002S11.0	–	11.00	0.4331	94.0	142.0	11.00
A002S11.5	–	11.50	0.4528	94.0	142.0	11.50
A002S12.0	–	12.00	0.4724	101.0	151.0	12.00
A002S12.5	–	12.50	0.4921	101.0	151.0	12.50
A002S1/2	1/2	12.70	0.5000	101.0	151.0	12.70
A002S13.0	–	13.00	0.5118	101.0	151.0	13.00



A100



HSS vrták, Parní temperace povrchu

Univerzální celobroušený vrták s vrcholovým úhlem 118° pro zvýšení odolnosti proti opotřebení a usnadnění přebroušování. Lze použít pro strojní i ruční vrtání. Parní temperace povrchu zadržuje řeznou kapalinu a zabraňuje nalepování třísek. Vhodný pro širokou oblast obráběných materiálů.

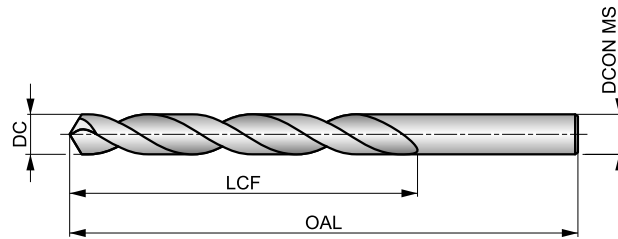

HSS	DIN 338	4×D
118°	ST	
λ 20-35°	R	DC h8

Skupiny obráběných materiálů, startovní řezná rychlost (Vc m/min) a kód posuvu. Tabulku s posuvem na otáčku naleznete od strany 175.

P1.1 ■ 33 H	P1.2 ■ 37 H	P1.3 ■ 38 H	P2.1 ■ 28 H	P2.2 ■ 25 F	P2.3 ■ 22 E	P3.1 ■ 19 F	P3.2 ■ 15 F	P3.3 ■ 13 E	P4.1 ■ 11 F	P4.2 ■ 10 E	P4.3 ■ 8 D	M1.1 ■ 21 E	M1.2 ■ 17 E
M2.1 ■ 18 E	M2.2 ■ 15 E	M3.1 ■ 9 G	M3.2 ■ 8 G	M3.3 ■ 7 G	M4.1 ■ 9 C	K1.1 ■ 30 H	K1.2 ■ 22 F	K1.3 ■ 17 F	K2.1 ■ 25 E	K2.2 ■ 20 E	K2.3 ■ 16 E	K3.1 ■ 22 E	K3.2 ■ 17 E
K3.3 ■ 13 E	K4.1 ■ 20 E	K4.2 ■ 15 E	K4.3 ■ 11 E	K4.4 ■ 10 E	K4.5 ■ 8 E	K5.1 ■ 23 E	K5.2 ■ 17 E	K5.3 ■ 13 E	N1.1 ■ 33 J	N1.2 ■ 25 J	N1.3 ■ 17 I	N2.1 ■ 42 H	N2.2 ■ 37 H
N2.3 ■ 27 H	N3.1 ■ 59 H	N3.2 ■ 35 I	N3.3 ■ 18 G	N4.1 ■ 30 J	N4.2 ■ 28 H	N4.3 ■ 14 F	S1.1 ■ 23 E	S1.2 ■ 12 D	S1.3 ■ 6 B	S2.1 ■ 8 E	S2.2 ■ 4 A	S3.1 ■ 6 E	S3.2 ■ 3 A
S4.1 ■ 5 E	S4.2 ■ 2 A												

DC ≤ 1mm (3/64") - leštěný.

Produkty nabízíme i v sadě. Vyhledejte A190, A191 nebo A199.

Produkt	DC	DC	DC	LCF	OAL	DCON MS	Produkt	DC	DC	DC	LCF	OAL	DCON MS
	(inch)	(mm)	(inch)	(mm)	(mm)	(mm)		(inch)	(mm)	(inch)	(mm)	(mm)	(mm)
A100.2	–	0.20	0.0079	2.5	19.0	0.20	A100.6	–	0.60	0.0236	7.0	24.0	0.60
A100.25	–	0.25	0.0098	3.0	19.0	0.25	A100N73	N73	0.61	0.0240	8.0	26.0	0.61
A100.3	–	0.30	0.0118	3.0	19.0	0.30	A100.62	–	0.62	0.0244	8.0	26.0	0.62
A100.32	–	0.32	0.0126	4.0	19.0	0.32	A100N72	N72	0.64	0.0250	8.0	26.0	0.64
A100N80	N80	0.34	0.0135	4.0	19.0	0.34	A100.65	–	0.65	0.0256	8.0	26.0	0.65
A100.35	–	0.35	0.0138	4.0	19.0	0.35	A100N71	N71	0.66	0.0260	8.0	26.0	0.66
A100N79	N79	0.37	0.0145	4.0	19.0	0.37	A100.68	–	0.68	0.0268	9.0	28.0	0.68
A100.38	–	0.38	0.0150	4.0	19.0	0.38	A100.7	–	0.70	0.0276	9.0	28.0	0.70
A1001/64	1/64	0.40	0.0156	5.0	20.0	0.40	A100N70	N70	0.71	0.0280	9.0	28.0	0.71
A100.4	–	0.40	0.0157	5.0	20.0	0.40	A100.72	–	0.72	0.0283	9.0	28.0	0.72
A100N78	N78	0.41	0.0160	5.0	20.0	0.41	A100N69	N69	0.74	0.0292	9.0	28.0	0.74
A100.42	–	0.42	0.0165	5.0	20.0	0.42	A100.75	–	0.75	0.0295	9.0	28.0	0.75
A100.45	–	0.45	0.0177	5.0	20.0	0.45	A100.78	–	0.78	0.0307	10.0	30.0	0.78
A100N77	N77	0.46	0.0180	5.0	20.0	0.46	A1001/32	1/32	0.79	0.0313	10.0	30.0	0.79
A100.48	–	0.48	0.0189	5.0	20.0	0.48	A100N68	N68	0.79	0.0310	10.0	30.0	0.79
A100.5	–	0.50	0.0197	6.0	22.0	0.50	A100.8	–	0.80	0.0315	10.0	30.0	0.80
A100N76	N76	0.51	0.0200	6.0	22.0	0.51	A100N67	N67	0.81	0.0320	10.0	30.0	0.81
A100.52	–	0.52	0.0205	6.0	22.0	0.52	A100.82	–	0.82	0.0323	10.0	30.0	0.82
A100N75	N75	0.53	0.0210	6.0	22.0	0.53	A100N66	N66	0.84	0.0330	10.0	30.0	0.84
A100.55	–	0.55	0.0217	7.0	24.0	0.55	A100.85	–	0.85	0.0335	10.0	30.0	0.85
A100N74	N74	0.57	0.0225	7.0	24.0	0.57	A100.88	–	0.88	0.0346	11.0	32.0	0.88
A100.58	–	0.58	0.0228	7.0	24.0	0.58	A100N65	N65	0.89	0.0350	11.0	32.0	0.89



Produkt	DC	DC	DC	LCF	OAL	D CON MS
	(inch)	(mm)	(inch)	(mm)	(mm)	(mm)
A100.9	–	0.90	0.0354	11.0	32.0	0.90
A100N64	N64	0.91	0.0360	11.0	32.0	0.91
A100.92	–	0.92	0.0362	11.0	32.0	0.92
A100N63	N63	0.94	0.0370	11.0	32.0	0.94
A100.95	–	0.95	0.0374	11.0	32.0	0.95
A100N62	N62	0.97	0.0380	12.0	34.0	0.97
A100.98	–	0.98	0.0386	12.0	34.0	0.98
A100N61	N61	0.99	0.0390	12.0	34.0	0.99
A1001.0	–	1.00	0.0394	12.0	34.0	1.00
A100N60	N60	1.02	0.0400	12.0	34.0	1.02
A100N59	N59	1.04	0.0410	12.0	34.0	1.04
A1001.05	–	1.05	0.0413	12.0	34.0	1.05
A100N58	N58	1.07	0.0420	14.0	36.0	1.07
A100N57	N57	1.09	0.0430	14.0	36.0	1.09
A1001.1	–	1.10	0.0433	14.0	36.0	1.10
A1001.15	–	1.15	0.0453	14.0	36.0	1.15
A100N56	N56	1.18	0.0465	14.0	36.0	1.18
A1003/64	3/64	1.19	0.0469	16.0	38.0	1.19
A1001.2	–	1.20	0.0472	16.0	38.0	1.20
A1001.25	–	1.25	0.0492	16.0	38.0	1.25
A1001.3	–	1.30	0.0512	16.0	38.0	1.30
A100N55	N55	1.32	0.0520	16.0	38.0	1.32
A1001.35	–	1.35	0.0531	18.0	40.0	1.35
A1001.4	–	1.40	0.0551	18.0	40.0	1.40
A100N54	N54	1.40	0.0550	18.0	40.0	1.40
A1001.45	–	1.45	0.0571	18.0	40.0	1.45
A1001.5	–	1.50	0.0591	18.0	40.0	1.50
A100N53	N53	1.51	0.0595	20.0	43.0	1.51
A1001.55	–	1.55	0.0610	20.0	43.0	1.55
A1001/16	1/16	1.59	0.0625	20.0	43.0	1.59
A1001.6	–	1.60	0.0630	20.0	43.0	1.60
A100N52	N52	1.61	0.0635	20.0	43.0	1.61
A1001.65	–	1.65	0.0650	20.0	43.0	1.65
A1001.7	–	1.70	0.0669	20.0	43.0	1.70
A100N51	N51	1.70	0.0670	22.0	46.0	1.70
A1001.75	–	1.75	0.0689	22.0	46.0	1.75
A100N50	N50	1.78	0.0700	22.0	46.0	1.78
A1001.8	–	1.80	0.0709	22.0	46.0	1.80
A1001.85	–	1.85	0.0728	22.0	46.0	1.85
A100N49	N49	1.85	0.0730	22.0	46.0	1.85
A1001.9	–	1.90	0.0748	22.0	46.0	1.90
A100N48	N48	1.93	0.0760	24.0	49.0	1.93
A1001.95	–	1.95	0.0768	24.0	49.0	1.95
A1005/64	5/64	1.98	0.0781	24.0	49.0	1.98
A100N47	N47	1.99	0.0785	24.0	49.0	1.99
A1002.0	–	2.00	0.0787	24.0	49.0	2.00
A1002.05	–	2.05	0.0807	24.0	49.0	2.05
A100N46	N46	2.06	0.0810	24.0	49.0	2.06
A100N45	N45	2.08	0.0820	24.0	49.0	2.08
A1002.1	–	2.10	0.0827	24.0	49.0	2.10
A1002.15	–	2.15	0.0846	27.0	53.0	2.15
A100N44	N44	2.18	0.0860	27.0	53.0	2.18
A1002.2	–	2.20	0.0866	27.0	53.0	2.20
A1002.25	–	2.25	0.0886	27.0	53.0	2.25
A100N43	N43	2.26	0.0890	27.0	53.0	2.26
A1002.3	–	2.30	0.0906	27.0	53.0	2.30
A1002.35	–	2.35	0.0925	27.0	53.0	2.35
A1003/32	3/32	2.38	0.0938	30.0	57.0	2.38
A100N42	N42	2.38	0.0935	30.0	57.0	2.38
A1002.4	–	2.40	0.0945	30.0	57.0	2.40
A100N41	N41	2.44	0.0960	30.0	57.0	2.44
A1002.45	–	2.45	0.0965	30.0	57.0	2.45

Produkt	DC	DC	DC	LCF	OAL	D CON MS
	(inch)	(mm)	(inch)	(mm)	(mm)	(mm)
A100N40	N40	2.49	0.0980	30.0	57.0	2.49
A1002.5	–	2.50	0.0984	30.0	57.0	2.50
A100N39	N39	2.53	0.0995	30.0	57.0	2.53
A1002.55	–	2.55	0.1004	30.0	57.0	2.55
A100N38	N38	2.58	0.1015	30.0	57.0	2.58
A1002.6	–	2.60	0.1024	30.0	57.0	2.60
A100N37	N37	2.64	0.1040	30.0	57.0	2.64
A1002.65	–	2.65	0.1043	30.0	57.0	2.65
A1002.7	–	2.70	0.1063	33.0	61.0	2.70
A100N36	N36	2.71	0.1065	33.0	61.0	2.71
A1002.75	–	2.75	0.1083	33.0	61.0	2.75
A1007/64	7/64	2.78	0.1094	33.0	61.0	2.78
A100N35	N35	2.79	0.1100	33.0	61.0	2.79
A1002.8	–	2.80	0.1102	33.0	61.0	2.80
A100N34	N34	2.82	0.1110	33.0	61.0	2.82
A1002.85	–	2.85	0.1122	33.0	61.0	2.85
A100N33	N33	2.87	0.1130	33.0	61.0	2.87
A1002.9	–	2.90	0.1142	33.0	61.0	2.90
A1002.95	–	2.95	0.1161	33.0	61.0	2.95
A100N32	N32	2.95	0.1160	33.0	61.0	2.95
A1003.0	–	3.00	0.1181	33.0	61.0	3.00
A100N31	N31	3.05	0.1200	36.0	65.0	3.05
A1003.1	–	3.10	0.1220	36.0	65.0	3.10
A1003.15	–	3.15	0.1240	36.0	65.0	3.15
A1001/8	1/8	3.18	0.1250	36.0	65.0	3.18
A1003.2	–	3.20	0.1260	36.0	65.0	3.20
A1003.25	–	3.25	0.1280	36.0	65.0	3.25
A100N30	N30	3.26	0.1285	36.0	65.0	3.26
A1003.3	–	3.30	0.1299	36.0	65.0	3.30
A1003.4	–	3.40	0.1339	39.0	70.0	3.40
A100N29	N29	3.45	0.1360	39.0	70.0	3.45
A1003.5	–	3.50	0.1378	39.0	70.0	3.50
A1009/64	9/64	3.57	0.1406	39.0	70.0	3.57
A100N28	N28	3.57	0.1405	39.0	70.0	3.57
A1003.6	–	3.60	0.1417	39.0	70.0	3.60
A100N27	N27	3.66	0.1440	39.0	70.0	3.66
A1003.7	–	3.70	0.1457	39.0	70.0	3.70
A100N26	N26	3.73	0.1470	39.0	70.0	3.73
A1003.75	–	3.75	0.1476	39.0	70.0	3.75
A1003.8	–	3.80	0.1496	43.0	75.0	3.80
A100N25	N25	3.80	0.1495	43.0	75.0	3.80
A100N24	N24	3.86	0.1520	43.0	75.0	3.86
A1003.9	–	3.90	0.1535	43.0	75.0	3.90
A100N23	N23	3.91	0.1540	43.0	75.0	3.91
A1005/32	5/32	3.97	0.1563	43.0	75.0	3.97
A100N22	N22	3.99	0.1570	43.0	75.0	3.99
A1004.0	–	4.00	0.1575	43.0	75.0	4.00
A100N21	N21	4.04	0.1590	43.0	75.0	4.04
A100N20	N20	4.09	0.1610	43.0	75.0	4.09
A1004.1	–	4.10	0.1614	43.0	75.0	4.10
A1004.2	–	4.20	0.1654	43.0	75.0	4.20
A100N19	N19	4.22	0.1660	43.0	75.0	4.22
A1004.25	–	4.25	0.1673	43.0	75.0	4.25
A1004.3	–	4.30	0.1693	47.0	80.0	4.30
A100N18	N18	4.31	0.1695	47.0	80.0	4.31
A10011/64	11/64	4.37	0.1719	47.0	80.0	4.37
A100N17	N17	4.39	0.1730	47.0	80.0	4.39
A1004.4	–	4.40	0.1732	47.0	80.0	4.40
A1004.5	–	4.50	0.1772	47.0	80.0	4.50
A100N16	N16	4.50	0.1770	47.0	80.0	4.50
A100N15	N15	4.57	0.1800	47.0	80.0	4.57
A1004.6	–	4.60	0.1811	47.0	80.0	4.60



Produkt	DC	DC	DC	LCF	OAL	DCON MS
	(inch)	(mm)	(inch)	(mm)	(mm)	(mm)
A100N14	N14	4.62	0.1820	47.0	80.0	4.62
A1004.7	–	4.70	0.1850	47.0	80.0	4.70
A100N13	N13	4.70	0.1850	47.0	80.0	4.70
A1004.75	–	4.75	0.1870	47.0	80.0	4.75
A1003/16	3/16	4.76	0.1875	52.0	86.0	4.76
A1004.8	–	4.80	0.1890	52.0	86.0	4.80
A100N12	N12	4.80	0.1890	52.0	86.0	4.80
A100N11	N11	4.85	0.1910	52.0	86.0	4.85
A1004.9	–	4.90	0.1929	52.0	86.0	4.90
A100N10	N10	4.92	0.1935	52.0	86.0	4.92
A100N9	N9	4.98	0.1960	52.0	86.0	4.98
A1005.0	–	5.00	0.1969	52.0	86.0	5.00
A100N8	N8	5.06	0.1990	52.0	86.0	5.06
A1005.1	–	5.10	0.2008	52.0	86.0	5.10
A100N7	N7	5.11	0.2010	52.0	86.0	5.11
A10013/64	13/64	5.16	0.2031	52.0	86.0	5.16
A100N6	N6	5.18	0.2040	52.0	86.0	5.18
A1005.2	–	5.20	0.2047	52.0	86.0	5.20
A100N5	N5	5.22	0.2055	52.0	86.0	5.22
A1005.25	–	5.25	0.2067	52.0	86.0	5.25
A1005.3	–	5.30	0.2087	52.0	86.0	5.30
A100N4	N4	5.31	0.2090	57.0	93.0	5.31
A1005.4	–	5.40	0.2126	57.0	93.0	5.40
A100N3	N3	5.41	0.2130	57.0	93.0	5.41
A1005.5	–	5.50	0.2165	57.0	93.0	5.50
A1007/32	7/32	5.56	0.2188	57.0	93.0	5.56
A1005.6	–	5.60	0.2205	57.0	93.0	5.60
A100N2	N2	5.61	0.2210	57.0	93.0	5.61
A1005.7	–	5.70	0.2244	57.0	93.0	5.70
A1005.75	–	5.75	0.2264	57.0	93.0	5.75
A100N1	1	5.79	0.2280	57.0	93.0	5.79
A1005.8	–	5.80	0.2283	57.0	93.0	5.80
A1005.9	–	5.90	0.2323	57.0	93.0	5.90
A100A	A	5.94	0.2340	57.0	93.0	5.94
A10015/64	15/64	5.95	0.2344	57.0	93.0	5.95
A1006.0	–	6.00	0.2362	57.0	93.0	6.00
A100B	B	6.03	0.2380	63.0	101.0	6.03
A1006.1	–	6.10	0.2402	63.0	101.0	6.10
A100C	C	6.15	0.2420	63.0	101.0	6.15
A1006.2	–	6.20	0.2441	63.0	101.0	6.20
A1006.25	–	6.25	0.2461	63.0	101.0	6.25
A100D	D	6.25	0.2460	63.0	101.0	6.25
A1006.3	–	6.30	0.2480	63.0	101.0	6.30
A1001/4	1/4	6.35	0.2500	63.0	101.0	6.35
A100E	E	6.35	0.2500	63.0	101.0	6.35
A1006.4	–	6.40	0.2520	63.0	101.0	6.40
A1006.5	–	6.50	0.2559	63.0	101.0	6.50
A100F	F	6.53	0.2570	63.0	101.0	6.53
A1006.6	–	6.60	0.2598	63.0	101.0	6.60
A100G	G	6.63	0.2610	63.0	101.0	6.63
A1006.7	–	6.70	0.2638	63.0	101.0	6.70
A10017/64	17/64	6.75	0.2656	69.0	109.0	6.75
A1006.75	–	6.75	0.2657	69.0	109.0	6.75
A100H	H	6.76	0.2660	69.0	109.0	6.76
A1006.8	–	6.80	0.2677	69.0	109.0	6.80
A1006.9	–	6.90	0.2717	69.0	109.0	6.90
A100I	I	6.91	0.2720	69.0	109.0	6.91
A1007.0	–	7.00	0.2756	69.0	109.0	7.00
A100J	J	7.04	0.2770	69.0	109.0	7.04
A1007.1	–	7.10	0.2795	69.0	109.0	7.10
A1009/32	9/32	7.14	0.2813	69.0	109.0	7.14
A100K	K	7.14	0.2810	69.0	109.0	7.14

Produkt	DC	DC	DC	LCF	OAL	DCON MS
	(inch)	(mm)	(inch)	(mm)	(mm)	(mm)
A1007.2	–	7.20	0.2835	69.0	109.0	7.20
A1007.25	–	7.25	0.2854	69.0	109.0	7.25
A1007.3	–	7.30	0.2874	69.0	109.0	7.30
A100L	L	7.37	0.2900	69.0	109.0	7.37
A1007.4	–	7.40	0.2913	69.0	109.0	7.40
A100M	M	7.49	0.2949	69.0	109.0	7.49
A1007.5	–	7.50	0.2953	69.0	109.0	7.50
A10019/64	19/64	7.54	0.2969	75.0	117.0	7.54
A1007.6	–	7.60	0.2992	75.0	117.0	7.60
A100N	N	7.67	0.3020	75.0	117.0	7.67
A1007.7	–	7.70	0.3031	75.0	117.0	7.70
A1007.75	–	7.75	0.3051	75.0	117.0	7.75
A1007.8	–	7.80	0.3071	75.0	117.0	7.80
A1007.9	–	7.90	0.3110	75.0	117.0	7.90
A1005/16	5/16	7.94	0.3125	75.0	117.0	7.94
A1008.0	–	8.00	0.3150	75.0	117.0	8.00
A100O	O	8.03	0.3160	75.0	117.0	8.03
A1008.1	–	8.10	0.3189	75.0	117.0	8.10
A1008.2	–	8.20	0.3228	75.0	117.0	8.20
A100P	P	8.20	0.3230	75.0	117.0	8.20
A1008.25	–	8.25	0.3248	75.0	117.0	8.25
A1008.3	–	8.30	0.3268	75.0	117.0	8.30
A10021/64	21/64	8.33	0.3281	75.0	117.0	8.33
A1008.4	–	8.40	0.3307	75.0	117.0	8.40
A100Q	Q	8.43	0.3320	75.0	117.0	8.43
A1008.5	–	8.50	0.3346	75.0	117.0	8.50
A1008.6	–	8.60	0.3386	81.0	125.0	8.60
A100R	R	8.61	0.3390	81.0	125.0	8.61
A1008.7	–	8.70	0.3425	81.0	125.0	8.70
A10011/32	11/32	8.73	0.3438	81.0	125.0	8.73
A1008.75	–	8.75	0.3445	81.0	125.0	8.75
A1008.8	–	8.80	0.3465	81.0	125.0	8.80
A100S	S	8.84	0.3480	81.0	125.0	8.84
A1008.9	–	8.90	0.3504	81.0	125.0	8.90
A1009.0	–	9.00	0.3543	81.0	125.0	9.00
A100T	T	9.09	0.3580	81.0	125.0	9.09
A1009.1	–	9.10	0.3583	81.0	125.0	9.10
A10023/64	23/64	9.13	0.3594	81.0	125.0	9.13
A1009.2	–	9.20	0.3622	81.0	125.0	9.20
A1009.25	–	9.25	0.3642	81.0	125.0	9.25
A1009.3	–	9.30	0.3661	81.0	125.0	9.30
A100U	U	9.35	0.3680	81.0	125.0	9.35
A1009.4	–	9.40	0.3701	81.0	125.0	9.40
A1009.5	–	9.50	0.3740	81.0	125.0	9.50
A1003/8	3/8	9.52	0.3750	87.0	133.0	9.52
A100V	V	9.58	0.3770	87.0	133.0	9.58
A1009.6	–	9.60	0.3780	87.0	133.0	9.60
A1009.7	–	9.70	0.3819	87.0	133.0	9.70
A1009.75	–	9.75	0.3839	87.0	133.0	9.75
A1009.8	–	9.80	0.3858	87.0	133.0	9.80
A100W	W	9.80	0.3860	87.0	133.0	9.80
A1009.9	–	9.90	0.3898	87.0	133.0	9.90
A10025/64	25/64	9.92	0.3906	87.0	133.0	9.92
A10010.0	–	10.00	0.3937	87.0	133.0	10.00
A100X	X	10.08	0.3970	87.0	133.0	10.08
A10010.1	–	10.10	0.3976	87.0	133.0	10.10
A10010.2	–	10.20	0.4016	87.0	133.0	10.20
A10010.25	–	10.25	0.4035	87.0	133.0	10.25
A100Y	Y	10.26	0.4040	87.0	133.0	10.26
A10010.3	–	10.30	0.4055	87.0	133.0	10.30
A10013/32	13/32	10.32	0.4063	87.0	133.0	10.32
A10010.4	–	10.40	0.4094	87.0	133.0	10.40



Produkt	DC	DC	DC	LCF	OAL	D CON MS
	(inch)	(mm)	(inch)	(mm)	(mm)	(mm)
A100Z	Z	10.49	0.4130	87.0	133.0	10.49
A10010.5	–	10.50	0.4134	87.0	133.0	10.50
A10010.6	–	10.60	0.4173	87.0	133.0	10.60
A10010.7	–	10.70	0.4213	94.0	142.0	10.70
A10027/64	27/64	10.72	0.4219	94.0	142.0	10.72
A10010.75	–	10.75	0.4232	94.0	142.0	10.75
A10010.8	–	10.80	0.4252	94.0	142.0	10.80
A10010.9	–	10.90	0.4291	94.0	142.0	10.90
A10011.0	–	11.00	0.4331	94.0	142.0	11.00
A10011.1	–	11.10	0.4370	94.0	142.0	11.10
A1007/16	7/16	11.11	0.4375	94.0	142.0	11.11
A10011.2	–	11.20	0.4409	94.0	142.0	11.20
A10011.25	–	11.25	0.4429	94.0	142.0	11.25
A10011.3	–	11.30	0.4449	94.0	142.0	11.30
A10011.4	–	11.40	0.4488	94.0	142.0	11.40
A10011.5	–	11.50	0.4528	94.0	142.0	11.50
A10029/64	29/64	11.51	0.4531	94.0	142.0	11.51
A10011.6	–	11.60	0.4567	94.0	142.0	11.60
A10011.7	–	11.70	0.4606	94.0	142.0	11.70
A10011.75	–	11.75	0.4626	94.0	142.0	11.75
A10011.8	–	11.80	0.4646	94.0	142.0	11.80
A10011.9	–	11.90	0.4685	101.0	151.0	11.90
A10015/32	15/32	11.91	0.4688	101.0	151.0	11.91
A10012.0	–	12.00	0.4724	101.0	151.0	12.00
A10012.1	–	12.10	0.4764	101.0	151.0	12.10
A10012.2	–	12.20	0.4803	101.0	151.0	12.20
A10012.25	–	12.25	0.4823	101.0	151.0	12.25
A10012.3	–	12.30	0.4843	101.0	151.0	12.30
A10031/64	31/64	12.30	0.4844	101.0	151.0	12.30
A10012.4	–	12.40	0.4882	101.0	151.0	12.40
A10012.5	–	12.50	0.4921	101.0	151.0	12.50
A10012.6	–	12.60	0.4961	101.0	151.0	12.60
A10012.7	–	12.70	0.5000	101.0	151.0	12.70
A1001/2	1/2	12.70	0.5000	101.0	151.0	12.70
A10012.75	–	12.75	0.5020	101.0	151.0	12.75
A10012.8	–	12.80	0.5039	101.0	151.0	12.80
A10012.9	–	12.90	0.5079	101.0	151.0	12.90
A10013.0	–	13.00	0.5118	101.0	151.0	13.00
A10033/64	33/64	13.10	0.5156	101.0	151.0	13.10

Produkt	DC	DC	DC	LCF	OAL	D CON MS
	(inch)	(mm)	(inch)	(mm)	(mm)	(mm)
A10013.1	–	13.10	0.5157	101.0	151.0	13.10
A10013.2	–	13.20	0.5197	101.0	151.0	13.20
A10013.25	–	13.25	0.5217	108.0	160.0	13.25
A10013.3	–	13.30	0.5236	108.0	160.0	13.30
A10013.4	–	13.40	0.5276	108.0	160.0	13.40
A10017/32	17/32	13.49	0.5313	108.0	160.0	13.49
A10013.5	–	13.50	0.5315	108.0	160.0	13.50
A10013.6	–	13.60	0.5354	108.0	160.0	13.60
A10013.7	–	13.70	0.5394	108.0	160.0	13.70
A10013.75	–	13.75	0.5413	108.0	160.0	13.75
A10013.8	–	13.80	0.5433	108.0	160.0	13.80
A10035/64	35/64	13.89	0.5469	108.0	160.0	13.89
A10013.9	–	13.90	0.5472	108.0	160.0	13.90
A10014.0	–	14.00	0.5512	108.0	160.0	14.00
A10014.25	–	14.25	0.5610	114.0	169.0	14.25
A1009/16	9/16	14.29	0.5625	114.0	169.0	14.29
A10014.5	–	14.50	0.5709	114.0	169.0	14.50
A10037/64	37/64	14.68	0.5781	114.0	169.0	14.68
A10014.75	–	14.75	0.5807	114.0	169.0	14.75
A10015.0	–	15.00	0.5906	114.0	169.0	15.00
A10019/32	19/32	15.08	0.5938	120.0	178.0	15.08
A10015.25	–	15.25	0.6004	120.0	178.0	15.25
A10039/64	39/64	15.48	0.6094	120.0	178.0	15.48
A10015.5	–	15.50	0.6102	120.0	178.0	15.50
A10015.75	–	15.75	0.6201	120.0	178.0	15.75
A1005/8	5/8	15.88	0.6250	120.0	178.0	15.88
A10016.0	–	16.00	0.6299	120.0	178.0	16.00
A10041/64	41/64	16.27	0.6406	125.0	184.0	16.27
A10016.5	–	16.50	0.6496	125.0	184.0	16.50
A10021/32	21/32	16.67	0.6563	125.0	184.0	16.67
A10017.0	–	17.00	0.6693	125.0	184.0	17.00
A10043/64	43/64	17.07	0.6719	130.0	191.0	17.07
A10011/16	11/16	17.46	0.6875	130.0	191.0	17.46
A10017.5	–	17.50	0.6890	130.0	191.0	17.50
A10018.0	–	18.00	0.7087	130.0	191.0	18.00
A10018.5	–	18.50	0.7283	135.0	198.0	18.50
A10019.0	–	19.00	0.7480	135.0	198.0	19.00
A10019.5	–	19.50	0.7677	140.0	205.0	19.50
A10020.0	–	20.00	0.7874	140.0	205.0	20.00



A101



HSS Levotočivý vrták, Parní temperace povrchu

Univerzální levotočivý vrták s parní temperací povrchu. Standardní vrcholový úhel vrtáku 118° pro odolnější břit a snazší a ekonomické přebušování. Parní temperace povrchu zadržuje řeznou kapalinu a brání nalepování třísek. Vhodný pro širokou oblast obráběných materiálů.

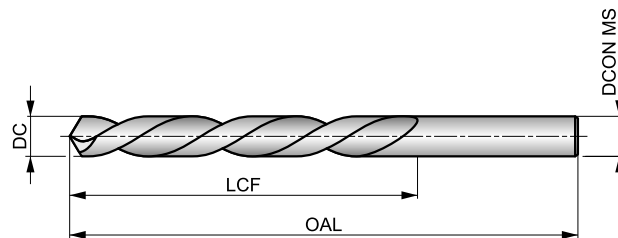

HSS	DIN 338	4×D
118°	ST	
20-35°	L	DC h8

Skupiny obráběných materiálů, startovní řezná rychlost (Vc m/min) a kód posuvu. Tabulku s posuvem na otáčku naleznete od strany 175.

P1.1 ■ 33 H	P1.2 ■ 37 H	P1.3 ■ 38 H	P2.1 ■ 28 H	P2.2 ■ 25 F	P2.3 ■ 22 E	P3.1 ■ 19 F	P3.2 ■ 15 F	P3.3 ■ 13 E	P4.1 ■ 11 F	P4.2 ■ 10 E	P4.3 ■ 8 D	M1.1 ■ 21 E	M1.2 ■ 17 E
M2.1 ■ 18 E	M2.2 ■ 15 E	M3.1 ■ 9 G	M3.2 ■ 8 G	M3.3 ■ 7 G	M4.1 ■ 9 C	K1.1 ■ 30 H	K1.2 ■ 22 F	K1.3 ■ 17 F	K2.1 ■ 25 E	K2.2 ■ 20 E	K2.3 ■ 16 E	K3.1 ■ 22 E	K3.2 ■ 17 E
K3.3 ■ 13 E	K4.1 ■ 20 E	K4.2 ■ 15 E	K4.3 ■ 11 E	K4.4 ■ 10 E	K4.5 ■ 8 E	K5.1 ■ 23 E	K5.2 ■ 17 E	K5.3 ■ 13 E	N1.1 ■ 33 J	N1.2 ■ 25 J	N1.3 ■ 17 I	N2.1 ■ 42 H	N2.2 ■ 37 H
N2.3 ■ 27 H	N3.1 ■ 59 H	N3.2 ■ 35 I	N3.3 ■ 18 G	N4.1 ■ 30 J	N4.2 ■ 28 H	N4.3 ■ 14 F	S1.1 ■ 23 E	S1.2 ■ 12 D	S1.3 ■ 6 B	S2.1 ■ 8 E	S2.2 ■ 4 A	S3.1 ■ 6 E	S3.2 ■ 3 A
S4.1 ■ 5 E	S4.2 ■ 2 A												

DC ≤ 3mm - leštěný.

Produkt	DC	DC	LCF	OAL	DCON MS	Produkt	DC	DC	LCF	OAL	DCON MS
	(mm)	(inch)					(mm)	(mm)			
A1011.0	1.00	0.0394	12.0	34.0	1.00	A1013.2	3.20	0.1260	36.0	65.0	3.20
A1011.1	1.10	0.0433	14.0	36.0	1.10	A1013.3	3.30	0.1299	36.0	65.0	3.30
A1011.2	1.20	0.0472	16.0	38.0	1.20	A1013.5	3.50	0.1378	39.0	70.0	3.50
A1011.25	1.25	0.0492	16.0	38.0	1.25	A1013.8	3.80	0.1496	43.0	75.0	3.80
A1011.3	1.30	0.0512	16.0	38.0	1.30	A1014.0	4.00	0.1575	43.0	75.0	4.00
A1011.4	1.40	0.0551	18.0	40.0	1.40	A1014.2	4.20	0.1654	43.0	75.0	4.20
A1011.5	1.50	0.0591	18.0	40.0	1.50	A1014.5	4.50	0.1772	47.0	80.0	4.50
A1011.6	1.60	0.0630	20.0	43.0	1.60	A1014.8	4.80	0.1890	52.0	86.0	4.80
A1011.7	1.70	0.0669	20.0	43.0	1.70	A1015.0	5.00	0.1969	52.0	86.0	5.00
A1011.8	1.80	0.0709	22.0	46.0	1.80	A1015.1	5.10	0.2008	52.0	86.0	5.10
A1011.9	1.90	0.0748	22.0	46.0	1.90	A1015.2	5.20	0.2047	52.0	86.0	5.20
A1012.0	2.00	0.0787	24.0	49.0	2.00	A1015.5	5.50	0.2165	57.0	93.0	5.50
A1012.1	2.10	0.0827	24.0	49.0	2.10	A1016.0	6.00	0.2362	57.0	93.0	6.00
A1012.2	2.20	0.0866	27.0	53.0	2.20	A1016.5	6.50	0.2559	63.0	101.0	6.50
A1012.3	2.30	0.0906	27.0	53.0	2.30	A1017.0	7.00	0.2756	69.0	109.0	7.00
A1012.4	2.40	0.0945	30.0	57.0	2.40	A1017.5	7.50	0.2953	69.0	109.0	7.50
A1012.5	2.50	0.0984	30.0	57.0	2.50	A1018.0	8.00	0.3150	75.0	117.0	8.00
A1012.6	2.60	0.1024	30.0	57.0	2.60	A1018.5	8.50	0.3346	75.0	117.0	8.50
A1012.7	2.70	0.1063	33.0	61.0	2.70	A1019.0	9.00	0.3543	81.0	125.0	9.00
A1012.8	2.80	0.1102	33.0	61.0	2.80	A10110.0	10.00	0.3937	87.0	133.0	10.00
A1012.9	2.90	0.1142	33.0	61.0	2.90	A10111.0	11.00	0.4331	94.0	142.0	11.00
A1013.0	3.00	0.1181	33.0	61.0	3.00	A10112.0	12.00	0.4724	101.0	151.0	12.00



A108



HSS Vrták, Parní temperace povrchu (pro nerez oceli)

První volba pro ruční vrtání nerez oceli, může být použit i pro strojní vrtání. Vrták s vrcholovým úhlem 135° napomáhá vystředění vrtáku a snižuje řezné síly. Parní temperace povrchu snižuje nalepování třísek na břit.

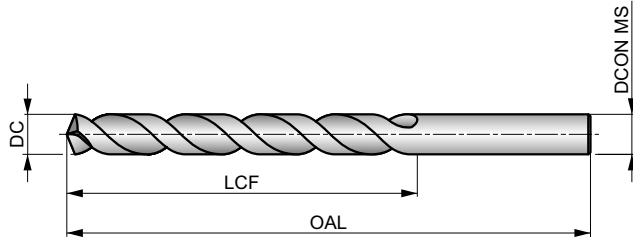

HSS	DIN 338	4xD
135°	ST	
λ>35°	R	DC h8

Skupiny obráběných materiálů, startovní řezná rychlost (Vc m/min) a kód posuvu. Tabulku s posuvem na otáčku naleznete od strany 175.

P1.1 □33 I	P1.2 □37 I	P1.3 □38 I	P2.1 □28 I	P2.2 □25 G	P2.3 □22 E	P3.1 □19 F	P3.2 □15 F	P3.3 □13 E	P4.1 □11 F	P4.2 □10 E	P4.3 □8 D	M1.1 □21 E	M1.2 □17 E
M2.1 □18 E	M2.2 □15 E	M3.1 ■10 G	M3.2 ■9 G	M3.3 ■8 G	M4.1 ■10 D	K1.1 □30 H	K1.2 □22 F	K1.3 □17 F	K2.1 □25 E	K2.2 □20 E	K2.3 □16 E	K3.1 □22 E	K3.2 □17 E
K3.3 □13 E	K4.1 □20 E	K4.2 □15 E	K4.3 □11 E	K4.4 □10 E	K4.5 □8 E	K5.1 □23 E	K5.2 □17 E	K5.3 □13 E	N1.1 □33 J	N1.2 □25 J	N1.3 □17 I	N2.1 □42 H	N2.2 □37 H
N2.3 □27 H	N3.1 □59 H	N3.2 □35 I	N3.3 □18 G	N4.1 □30 J	N4.2 □28 H	N4.3 □14 F	S1.1 ■25 G	S1.2 ■16 E	S1.3 □7 B	S2.1 □9 G	S2.2 □8 E	S3.1 □7 G	S3.2 □6 E
S4.1 □5 G	S4.2 □5 E												

DC > 1.5mm (1/16") - s příčným ostrím.
Produkty nabízíme i v sadě. Vyhledejte A188.

Produkt	DC (inch)	DC (mm)	DC (inch)	LCF (mm)	OAL (mm)	DCON MS (mm)
A1081.0	-	1.00	0.0394	12.0	34.0	1.00
A1081.1	-	1.10	0.0433	14.0	36.0	1.10
A1081.2	-	1.20	0.0472	16.0	38.0	1.20
A1081.3	-	1.30	0.0512	16.0	38.0	1.30
A1081.4	-	1.40	0.0551	18.0	40.0	1.40
A1081.5	-	1.50	0.0591	18.0	40.0	1.50
A1081/16	1/16	1.59	0.0625	20.0	43.0	1.59
A1081.6	-	1.60	0.0630	20.0	43.0	1.60
A1081.7	-	1.70	0.0669	20.0	43.0	1.70
A1081.8	-	1.80	0.0709	22.0	46.0	1.80
A1081.9	-	1.90	0.0748	22.0	46.0	1.90
A1085/64	5/64	1.98	0.0781	24.0	49.0	1.98
A1082.0	-	2.00	0.0787	24.0	49.0	2.00
A1082.1	-	2.10	0.0827	24.0	49.0	2.10
A1082.2	-	2.20	0.0866	27.0	53.0	2.20
A1082.3	-	2.30	0.0906	27.0	53.0	2.30
A1083/32	3/32	2.38	0.0938	30.0	57.0	2.38
A1082.4	-	2.40	0.0945	30.0	57.0	2.40
A1082.5	-	2.50	0.0984	30.0	57.0	2.50
A1082.6	-	2.60	0.1024	30.0	57.0	2.60
A1082.7	-	2.70	0.1063	33.0	61.0	2.70
A1087/64	7/64	2.78	0.1094	33.0	61.0	2.78

Produkt	DC (inch)	DC (mm)	DC (inch)	LCF (mm)	OAL (mm)	DCON MS (mm)
A1082.8	-	2.80	0.1102	33.0	61.0	2.80
A1082.9	-	2.90	0.1142	33.0	61.0	2.90
A1083.0	-	3.00	0.1181	33.0	61.0	3.00
A1083.1	-	3.10	0.1220	36.0	65.0	3.10
A1081/8	1/8	3.18	0.1250	36.0	65.0	3.18
A1083.2	-	3.20	0.1260	36.0	65.0	3.20
A1083.3	-	3.30	0.1299	36.0	65.0	3.30
A1083.4	-	3.40	0.1339	39.0	70.0	3.40
A1083.5	-	3.50	0.1378	39.0	70.0	3.50
A1089/64	9/64	3.57	0.1406	39.0	70.0	3.57
A1083.6	-	3.60	0.1417	39.0	70.0	3.60
A1083.7	-	3.70	0.1457	39.0	70.0	3.70
A1083.8	-	3.80	0.1496	43.0	75.0	3.80
A1083.9	-	3.90	0.1535	43.0	75.0	3.90
A1085/32	5/32	3.97	0.1563	43.0	75.0	3.97
A1084.0	-	4.00	0.1575	43.0	75.0	4.00
A1084.1	-	4.10	0.1614	43.0	75.0	4.10
A1084.2	-	4.20	0.1654	43.0	75.0	4.20
A1084.3	-	4.30	0.1693	47.0	80.0	4.30
A10811/64	11/64	4.37	0.1719	47.0	80.0	4.37
A1084.4	-	4.40	0.1732	47.0	80.0	4.40
A1084.5	-	4.50	0.1772	47.0	80.0	4.50



Produkt	DC	DC	DC	LCF	OAL	DCON MS
	(inch)	(mm)	(inch)	(mm)	(mm)	(mm)
A1084.6	–	4.60	0.1811	47.0	80.0	4.60
A1084.7	–	4.70	0.1850	47.0	80.0	4.70
A1083/16	3/16	4.76	0.1875	52.0	86.0	4.76
A1084.8	–	4.80	0.1890	52.0	86.0	4.80
A1084.9	–	4.90	0.1929	52.0	86.0	4.90
A108N10	N10	4.92	0.1935	52.0	86.0	4.92
A1085.0	–	5.00	0.1969	52.0	86.0	5.00
A1085.1	–	5.10	0.2008	52.0	86.0	5.10
A10813/64	13/64	5.16	0.2031	52.0	86.0	5.16
A1085.2	–	5.20	0.2047	52.0	86.0	5.20
A1085.3	–	5.30	0.2087	52.0	86.0	5.30
A1085.4	–	5.40	0.2126	57.0	93.0	5.40
A1085.5	–	5.50	0.2165	57.0	93.0	5.50
A1087/32	7/32	5.56	0.2188	57.0	93.0	5.56
A1085.6	–	5.60	0.2205	57.0	93.0	5.60
A1085.7	–	5.70	0.2244	57.0	93.0	5.70
A1085.8	–	5.80	0.2283	57.0	93.0	5.80
A1085.9	–	5.90	0.2323	57.0	93.0	5.90
A10815/64	15/64	5.95	0.2344	57.0	93.0	5.95
A1086.0	–	6.00	0.2362	57.0	93.0	6.00
A1086.1	–	6.10	0.2402	63.0	101.0	6.10
A1086.2	–	6.20	0.2441	63.0	101.0	6.20
A1086.3	–	6.30	0.2480	63.0	101.0	6.30
A1081/4	1/4	6.35	0.2500	63.0	101.0	6.35
A1086.4	–	6.40	0.2520	63.0	101.0	6.40
A1086.5	–	6.50	0.2559	63.0	101.0	6.50
A1086.6	–	6.60	0.2598	63.0	101.0	6.60
A1086.7	–	6.70	0.2638	63.0	101.0	6.70
A10817/64	17/64	6.75	0.2656	69.0	109.0	6.75
A1086.8	–	6.80	0.2677	69.0	109.0	6.80
A1086.9	–	6.90	0.2717	69.0	109.0	6.90
A1087.0	–	7.00	0.2756	69.0	109.0	7.00
A1087.1	–	7.10	0.2795	69.0	109.0	7.10
A1089/32	9/32	7.14	0.2813	69.0	109.0	7.14
A1087.2	–	7.20	0.2835	69.0	109.0	7.20
A1087.3	–	7.30	0.2874	69.0	109.0	7.30
A1087.4	–	7.40	0.2913	69.0	109.0	7.40
A1087.5	–	7.50	0.2953	69.0	109.0	7.50
A10819/64	19/64	7.54	0.2969	75.0	117.0	7.54
A1087.6	–	7.60	0.2992	75.0	117.0	7.60
A1087.7	–	7.70	0.3031	75.0	117.0	7.70
A1087.8	–	7.80	0.3071	75.0	117.0	7.80
A1087.9	–	7.90	0.3110	75.0	117.0	7.90
A1085/16	5/16	7.94	0.3125	75.0	117.0	7.94
A1088.0	–	8.00	0.3150	75.0	117.0	8.00
A1088.1	–	8.10	0.3189	75.0	117.0	8.10
A1088.2	–	8.20	0.3228	75.0	117.0	8.20
A1088.3	–	8.30	0.3268	75.0	117.0	8.30

Produkt	DC	DC	DC	LCF	OAL	DCON MS
	(inch)	(mm)	(inch)	(mm)	(mm)	(mm)
A10821/64	21/64	8.33	0.3281	75.0	117.0	8.33
A1088.4	–	8.40	0.3307	75.0	117.0	8.40
A1088.5	–	8.50	0.3346	75.0	117.0	8.50
A1088.6	–	8.60	0.3386	81.0	125.0	8.60
A1088.7	–	8.70	0.3425	81.0	125.0	8.70
A10811/32	11/32	8.73	0.3438	81.0	125.0	8.73
A1088.8	–	8.80	0.3465	81.0	125.0	8.80
A1088.9	–	8.90	0.3504	81.0	125.0	8.90
A1089.0	–	9.00	0.3543	81.0	125.0	9.00
A1089.1	–	9.10	0.3583	81.0	125.0	9.10
A10823/64	23/64	9.13	0.3594	81.0	125.0	9.13
A1089.2	–	9.20	0.3622	81.0	125.0	9.20
A1089.3	–	9.30	0.3661	81.0	125.0	9.30
A1089.4	–	9.40	0.3701	81.0	125.0	9.40
A1089.5	–	9.50	0.3740	81.0	125.0	9.50
A1083/8	3/8	9.52	0.3750	87.0	133.0	9.52
A1089.6	–	9.60	0.3780	87.0	133.0	9.60
A1089.7	–	9.70	0.3819	87.0	133.0	9.70
A1089.8	–	9.80	0.3858	87.0	133.0	9.80
A1089.9	–	9.90	0.3898	87.0	133.0	9.90
A10825/64	25/64	9.92	0.3906	87.0	133.0	9.92
A10810.0	–	10.00	0.3937	87.0	133.0	10.00
A10810.2	–	10.20	0.4016	87.0	133.0	10.20
A10813/32	13/32	10.32	0.4063	87.0	133.0	10.32
A10810.5	–	10.50	0.4134	87.0	133.0	10.50
A10827/64	27/64	10.72	0.4219	94.0	142.0	10.72
A10810.8	–	10.80	0.4252	94.0	142.0	10.80
A10811.0	–	11.00	0.4331	94.0	142.0	11.00
A1087/16	7/16	11.11	0.4375	94.0	142.0	11.11
A10811.5	–	11.50	0.4528	94.0	142.0	11.50
A10829/64	29/64	11.51	0.4531	94.0	142.0	11.51
A10811.8	–	11.80	0.4646	94.0	142.0	11.80
A10815/32	15/32	11.91	0.4688	101.0	151.0	11.91
A10812.0	–	12.00	0.4724	101.0	151.0	12.00
A10812.2	–	12.20	0.4803	101.0	151.0	12.20
A10831/64	31/64	12.30	0.4844	101.0	151.0	12.30
A10812.5	–	12.50	0.4921	101.0	151.0	12.50
A1081/2	1/2	12.70	0.5000	101.0	151.0	12.70
A10812.8	–	12.80	0.5039	101.0	151.0	12.80
A10812.9	–	12.90	0.5079	101.0	151.0	12.90
A10813.0	–	13.00	0.5118	101.0	151.0	13.00
A10813.5	–	13.50	0.5315	108.0	160.0	13.50
A10814.0	–	14.00	0.5512	108.0	160.0	14.00
A10814.5	–	14.50	0.5709	114.0	169.0	14.50
A10815.0	–	15.00	0.5906	114.0	169.0	15.00
A10815.25	–	15.25	0.6004	120.0	178.0	15.25
A10815.5	–	15.50	0.6102	120.0	178.0	15.50
A10816.0	–	16.00	0.6299	120.0	178.0	16.00



A147



HSS-E (5 % kobaltu) Vrták, Leštěný (pro nerez ocel)

Univerzální vrták pro produktivní strojní vrtání nerez ocelí. Může být použit i pro ruční operace. Vrcholový úhel 130° napomáhá vystředění a snižuje řezné síly. Vrták je leštěný.

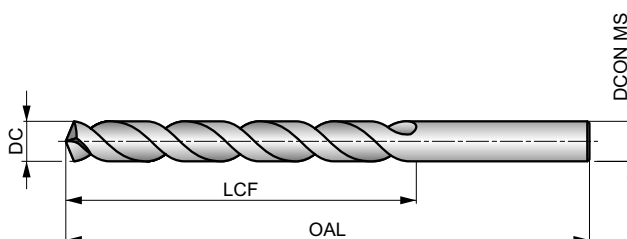

HSS-E	DIN 338	4xD
130°	Bright	
VA	R	DC h8

Skupiny obráběných materiálů, startovní řezná rychlost (Vc m/min) a kód posuvu. Tabulku s posuvem na otáčku naleznete od strany 175.

P1.1 □33 I	P1.2 □37 I	P1.3 □38 I	P2.1 □28 I	P2.2 □25 G	P2.3 □22 E	P3.1 □19 F	P3.2 □15 F	P3.3 □13 E	P4.1 □11 F	P4.2 □10 E	P4.3 □8 D	M1.1 ■21 E	M1.2 ■17 E
M2.1 ■18 E	M2.2 ■15 E	M2.3 □13 B	M3.1 ■10 G	M3.2 ■9 G	M3.3 ■8 G	M4.1 ■10 D	M4.2 □19 B	K1.1 □30 H	K1.2 □22 F	K1.3 □17 F	K2.1 □25 E	K2.2 □20 E	K2.3 □16 E
K3.1 □22 E	K3.2 □17 E	K3.3 □13 E	K4.1 □20 E	K4.2 □15 E	K4.3 □11 E	K4.4 □10 E	K4.5 □8 E	K5.1 □23 E	K5.2 □17 E	K5.3 □13 E	N1.1 □33 J	N1.2 □25 J	N1.3 □17 I
N2.1 □42 H	N2.2 □37 H	N2.3 □27 H	N3.1 □59 H	N3.2 □35 I	N3.3 □18 G	N4.1 □30 J	N4.2 □28 H	N4.3 □14 F	S1.1 ■25 G	S1.2 ■16 E	S1.3 □7 B	S2.1 □9 G	S2.2 □8 E
S3.1 □7 G	S3.2 □6 E	S4.1 □5 G	S4.2 □5 E										

Produkt	DC	DC	DC	LCF	OAL	DCON MS
	(inch)	(mm)	(inch)	(mm)	(mm)	(mm)
A147.3	–	0.30	0.0118	3.0	19.0	0.30
A147.4	–	0.40	0.0157	5.0	20.0	0.40
A147.5	–	0.50	0.0197	6.0	22.0	0.50
A147.6	–	0.60	0.0236	7.0	24.0	0.60
A147.7	–	0.70	0.0276	9.0	28.0	0.70
A147.8	–	0.80	0.0315	10.0	30.0	0.80
A147.9	–	0.90	0.0354	11.0	32.0	0.90
A1471.0	–	1.00	0.0394	12.0	34.0	1.00
A1471.1	–	1.10	0.0433	14.0	36.0	1.10
A1471.2	–	1.20	0.0472	16.0	38.0	1.20
A1471.3	–	1.30	0.0512	16.0	38.0	1.30
A1471.4	–	1.40	0.0551	18.0	40.0	1.40
A1471.5	–	1.50	0.0591	18.0	40.0	1.50
A1471/16	1/16	1.59	0.0625	20.0	43.0	1.59
A1471.6	–	1.60	0.0630	20.0	43.0	1.60
A1471.7	–	1.70	0.0669	20.0	43.0	1.70
A1471.8	–	1.80	0.0709	22.0	46.0	1.80
A1471.9	–	1.90	0.0748	22.0	46.0	1.90
A1472.0	–	2.00	0.0787	24.0	49.0	2.00
A1472.1	–	2.10	0.0827	24.0	49.0	2.10
A1472.2	–	2.20	0.0866	27.0	53.0	2.20
A1472.3	–	2.30	0.0906	27.0	53.0	2.30
A1473/32	3/32	2.38	0.0938	30.0	57.0	2.38
A1472.4	–	2.40	0.0945	30.0	57.0	2.40

Produkt	DC	DC	DC	LCF	OAL	DCON MS
	(inch)	(mm)	(inch)	(mm)	(mm)	(mm)
A1472.5	–	2.50	0.0984	30.0	57.0	2.50
A1472.6	–	2.60	0.1024	30.0	57.0	2.60
A1472.7	–	2.70	0.1063	33.0	61.0	2.70
A1472.8	–	2.80	0.1102	33.0	61.0	2.80
A1472.9	–	2.90	0.1142	33.0	61.0	2.90
A1473.0	–	3.00	0.1181	33.0	61.0	3.00
A1473.1	–	3.10	0.1220	36.0	65.0	3.10
A1471/8	1/8	3.18	0.1250	36.0	65.0	3.18
A1473.2	–	3.20	0.1260	36.0	65.0	3.20
A1473.3	–	3.30	0.1299	36.0	65.0	3.30
A1473.4	–	3.40	0.1339	39.0	70.0	3.40
A1473.5	–	3.50	0.1378	39.0	70.0	3.50
A1473.6	–	3.60	0.1417	39.0	70.0	3.60
A1473.7	–	3.70	0.1457	39.0	70.0	3.70
A1473.8	–	3.80	0.1496	43.0	75.0	3.80
A1473.9	–	3.90	0.1535	43.0	75.0	3.90
A1475/32	5/32	3.97	0.1563	43.0	75.0	3.97
A1474.0	–	4.00	0.1575	43.0	75.0	4.00
A1474.1	–	4.10	0.1614	43.0	75.0	4.10
A1474.2	–	4.20	0.1654	43.0	75.0	4.20
A1474.3	–	4.30	0.1693	47.0	80.0	4.30
A1474.4	–	4.40	0.1732	47.0	80.0	4.40
A1474.5	–	4.50	0.1772	47.0	80.0	4.50
A1474.6	–	4.60	0.1811	47.0	80.0	4.60



Produkt	DC	DC	DC	LCF	OAL	DCON MS
	(inch)	(mm)	(inch)	(mm)	(mm)	(mm)
A1474.7	–	4.70	0.1850	47.0	80.0	4.70
A1473/16	3/16	4.76	0.1875	52.0	86.0	4.76
A1474.8	–	4.80	0.1890	52.0	86.0	4.80
A1474.9	–	4.90	0.1929	52.0	86.0	4.90
A1475.0	–	5.00	0.1969	52.0	86.0	5.00
A1475.1	–	5.10	0.2008	52.0	86.0	5.10
A1475.2	–	5.20	0.2047	52.0	86.0	5.20
A1475.3	–	5.30	0.2087	52.0	86.0	5.30
A1475.4	–	5.40	0.2126	57.0	93.0	5.40
A1475.5	–	5.50	0.2165	57.0	93.0	5.50
A1475.6	–	5.60	0.2205	57.0	93.0	5.60
A1475.7	–	5.70	0.2244	57.0	93.0	5.70
A1475.8	–	5.80	0.2283	57.0	93.0	5.80
A1475.9	–	5.90	0.2323	57.0	93.0	5.90
A1476.0	–	6.00	0.2362	57.0	93.0	6.00
A1476.1	–	6.10	0.2402	63.0	101.0	6.10
A1476.2	–	6.20	0.2441	63.0	101.0	6.20
A1476.3	–	6.30	0.2480	63.0	101.0	6.30
A1471/4	1/4	6.35	0.2500	63.0	101.0	6.35
A1476.4	–	6.40	0.2520	63.0	101.0	6.40
A1476.5	–	6.50	0.2559	63.0	101.0	6.50
A1476.6	–	6.60	0.2598	63.0	101.0	6.60
A1476.7	–	6.70	0.2638	63.0	101.0	6.70
A1476.8	–	6.80	0.2677	69.0	109.0	6.80
A1476.9	–	6.90	0.2717	69.0	109.0	6.90
A1477.0	–	7.00	0.2756	69.0	109.0	7.00
A1477.1	–	7.10	0.2795	69.0	109.0	7.10
A1477.2	–	7.20	0.2835	69.0	109.0	7.20
A1477.3	–	7.30	0.2874	69.0	109.0	7.30
A1477.4	–	7.40	0.2913	69.0	109.0	7.40
A1477.5	–	7.50	0.2953	69.0	109.0	7.50
A1477.6	–	7.60	0.2992	75.0	117.0	7.60
A1477.7	–	7.70	0.3031	75.0	117.0	7.70
A1477.8	–	7.80	0.3071	75.0	117.0	7.80

Produkt	DC	DC	DC	LCF	OAL	DCON MS
	(inch)	(mm)	(inch)	(mm)	(mm)	(mm)
A1477.9	–	7.90	0.3110	75.0	117.0	7.90
A1478.0	–	8.00	0.3150	75.0	117.0	8.00
A1478.1	–	8.10	0.3189	75.0	117.0	8.10
A1478.2	–	8.20	0.3228	75.0	117.0	8.20
A1478.3	–	8.30	0.3268	75.0	117.0	8.30
A1478.4	–	8.40	0.3307	75.0	117.0	8.40
A1478.5	–	8.50	0.3346	75.0	117.0	8.50
A1478.6	–	8.60	0.3386	81.0	125.0	8.60
A1478.7	–	8.70	0.3425	81.0	125.0	8.70
A1478.8	–	8.80	0.3465	81.0	125.0	8.80
A1478.9	–	8.90	0.3504	81.0	125.0	8.90
A1479.0	–	9.00	0.3543	81.0	125.0	9.00
A1479.1	–	9.10	0.3583	81.0	125.0	9.10
A1479.2	–	9.20	0.3622	81.0	125.0	9.20
A1479.3	–	9.30	0.3661	81.0	125.0	9.30
A1479.4	–	9.40	0.3701	81.0	125.0	9.40
A1479.5	–	9.50	0.3740	81.0	125.0	9.50
A1479.6	–	9.60	0.3780	87.0	133.0	9.60
A1479.7	–	9.70	0.3819	87.0	133.0	9.70
A1479.8	–	9.80	0.3858	87.0	133.0	9.80
A1479.9	–	9.90	0.3898	87.0	133.0	9.90
A14710.0	–	10.00	0.3937	87.0	133.0	10.00
A14710.2	–	10.20	0.4016	87.0	133.0	10.20
A14710.5	–	10.50	0.4134	87.0	133.0	10.50
A14711.0	–	11.00	0.4331	94.0	142.0	11.00
A14711.2	–	11.20	0.4409	94.0	142.0	11.20
A14711.5	–	11.50	0.4528	94.0	142.0	11.50
A14712.0	–	12.00	0.4724	101.0	151.0	12.00
A14712.5	–	12.50	0.4921	101.0	151.0	12.50
A14713.0	–	13.00	0.5118	101.0	151.0	13.00
A14713.5	–	13.50	0.5315	108.0	160.0	13.50
A14714.0	–	14.00	0.5512	108.0	160.0	14.00
A14714.5	–	14.50	0.5709	114.0	169.0	14.50
A14715.0	–	15.00	0.5906	114.0	169.0	15.00



A777

HSS-E (8% kobaltu) Vrták, Povrchová úprava Bronz

Výkonný vrták pro přesné otvory s velmi dobrou kvalitou povrchu, vhodný pro vysoce pevnostní materiály. Vrcholový úhel 135° napomáhá vystředění vrtáku. Bronzový povrch je tenká oxidační vrstva použitá na HSS-E vrtácích s 8% kobaltu.

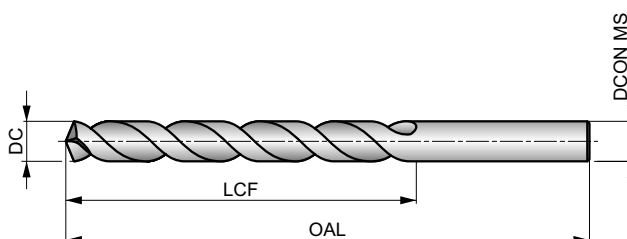

HSS-E	DIN 338	4xD
135°	Bronze	
λ 20-35°	R	DC h8

Skupiny obráběných materiálů, startovní řezná rychlost (Vc m/min) a kód posuvu. Tabulku s posuvem na otáčku naleznete od strany 175.

P1.1 ■ 36 H	P1.2 ■ 40 H	P1.3 ■ 41 H	P2.1 ■ 31 H	P2.2 ■ 27 G	P2.3 ■ 24 E	P3.1 ■ 25 F	P3.2 ■ 20 F	P3.3 ■ 17 E	P4.1 ■ 15 F	P4.2 ■ 13 E	P4.3 ■ 10 D	M1.1 ■ 30 E	M1.2 ■ 26 E
M2.1 ■ 27 E	M2.2 ■ 22 E	M3.1 ■ 13 G	M3.2 ■ 11 G	M3.3 ■ 10 G	M4.1 ■ 15 C	K1.1 ■ 35 H	K1.2 ■ 26 D	K1.3 ■ 19 D	K2.1 ■ 27 E	K2.2 ■ 22 E	K2.3 ■ 18 E	K3.1 ■ 24 E	K3.2 ■ 18 E
K3.3 ■ 15 E	K4.1 ■ 22 E	K4.2 ■ 17 E	K4.3 ■ 12 E	K4.4 ■ 11 E	K4.5 ■ 9 E	K5.1 ■ 25 E	K5.2 ■ 19 E	K5.3 ■ 15 E	N1.1 ■ 33 J	N1.2 ■ 25 J	N1.3 ■ 17 I	N2.1 ■ 46 H	N2.2 ■ 42 H
N2.3 ■ 30 H	N3.1 ■ 68 H	N3.2 ■ 40 F	N3.3 ■ 20 H	S1.1 ■ 28 F	S1.2 ■ 20 D	S1.3 ■ 11 C	S2.1 ■ 9 E	S2.2 ■ 8 B	S3.1 ■ 7 E	S3.2 ■ 6 B	S4.1 ■ 5 E	S4.2 ■ 5 B	

AS907J. DC <= 1,4 mm - 4 fasetkový vrchol.
Produkty nabízíme i v sadě. Vyhledejte A295.

Produkt	DC (inch)	DC (mm)	DC (inch)	LCF (mm)	OAL (mm)	DCON MS (mm)
A777.3	-	0.30	0.0118	3.0	19.0	0.30
A777.35	-	0.35	0.0138	4.0	19.0	0.35
A777.4	-	0.40	0.0157	5.0	20.0	0.40
A777.45	-	0.45	0.0177	5.0	20.0	0.45
A777.5	-	0.50	0.0197	6.0	22.0	0.50
A777.55	-	0.55	0.0217	7.0	24.0	0.55
A777.6	-	0.60	0.0236	7.0	24.0	0.60
A777.65	-	0.65	0.0256	8.0	26.0	0.65
A777.7	-	0.70	0.0276	9.0	28.0	0.70
A777.8	-	0.80	0.0315	10.0	30.0	0.80
A777.9	-	0.90	0.0354	11.0	32.0	0.90
A777.95	-	0.95	0.0374	11.0	32.0	0.95
A7771.0	-	1.00	0.0394	12.0	34.0	1.00
A7771.1	-	1.10	0.0433	14.0	36.0	1.10
A7771.2	-	1.20	0.0472	16.0	38.0	1.20
A7771.3	-	1.30	0.0512	16.0	38.0	1.30
A7771.4	-	1.40	0.0551	18.0	40.0	1.40
A7771.5	-	1.50	0.0591	18.0	40.0	1.50
A7771/16	1/16	1.59	0.0625	20.0	43.0	1.59
A7771.6	-	1.60	0.0630	20.0	43.0	1.60
A7771.7	-	1.70	0.0669	20.0	43.0	1.70
A7771.8	-	1.80	0.0709	22.0	46.0	1.80
A7771.9	-	1.90	0.0748	22.0	46.0	1.90
A7775/64	5/64	1.98	0.0781	24.0	49.0	1.98

Produkt	DC (inch)	DC (mm)	DC (inch)	LCF (mm)	OAL (mm)	DCON MS (mm)
A7772.0	-	2.00	0.0787	24.0	49.0	2.00
A7772.1	-	2.10	0.0827	24.0	49.0	2.10
A7772.2	-	2.20	0.0866	27.0	53.0	2.20
A7772.3	-	2.30	0.0906	27.0	53.0	2.30
A7773/32	3/32	2.38	0.0938	30.0	57.0	2.38
A7772.4	-	2.40	0.0945	30.0	57.0	2.40
A7772.5	-	2.50	0.0984	30.0	57.0	2.50
A7772.6	-	2.60	0.1024	30.0	57.0	2.60
A7772.7	-	2.70	0.1063	33.0	61.0	2.70
A7777/64	7/64	2.78	0.1094	33.0	61.0	2.78
A7772.8	-	2.80	0.1102	33.0	61.0	2.80
A7772.9	-	2.90	0.1142	33.0	61.0	2.90
A7773.0	-	3.00	0.1181	33.0	61.0	3.00
A7773.1	-	3.10	0.1220	36.0	65.0	3.10
A7771/8	1/8	3.18	0.1250	36.0	65.0	3.18
A7773.2	-	3.20	0.1260	36.0	65.0	3.20
A7773.3	-	3.30	0.1299	36.0	65.0	3.30
A7773.4	-	3.40	0.1339	39.0	70.0	3.40
A7773.5	-	3.50	0.1378	39.0	70.0	3.50
A7779/64	9/64	3.57	0.1406	39.0	70.0	3.57
A7773.6	-	3.60	0.1417	39.0	70.0	3.60
A7773.7	-	3.70	0.1457	39.0	70.0	3.70
A7773.8	-	3.80	0.1496	43.0	75.0	3.80
A7773.9	-	3.90	0.1535	43.0	75.0	3.90



Produkt	DC	DC	DC	LCF	OAL	D CON MS
	(inch)	(mm)	(inch)	(mm)	(mm)	(mm)
A7775/32	5/32	3.97	0.1563	43.0	75.0	3.97
A7774.0	–	4.00	0.1575	43.0	75.0	4.00
A7774.1	–	4.10	0.1614	43.0	75.0	4.10
A7774.2	–	4.20	0.1654	43.0	75.0	4.20
A7774.3	–	4.30	0.1693	47.0	80.0	4.30
A77711/64	11/64	4.37	0.1719	47.0	80.0	4.37
A7774.4	–	4.40	0.1732	47.0	80.0	4.40
A7774.5	–	4.50	0.1772	47.0	80.0	4.50
A7774.6	–	4.60	0.1811	47.0	80.0	4.60
A7774.7	–	4.70	0.1850	47.0	80.0	4.70
A7773/16	3/16	4.76	0.1875	52.0	86.0	4.76
A7774.8	–	4.80	0.1890	52.0	86.0	4.80
A7774.9	–	4.90	0.1929	52.0	86.0	4.90
A7775.0	–	5.00	0.1969	52.0	86.0	5.00
A7775.1	–	5.10	0.2008	52.0	86.0	5.10
A77713/64	13/64	5.16	0.2031	52.0	86.0	5.16
A7775.2	–	5.20	0.2047	52.0	86.0	5.20
A7775.3	–	5.30	0.2087	52.0	86.0	5.30
A7775.4	–	5.40	0.2126	57.0	93.0	5.40
A7775.5	–	5.50	0.2165	57.0	93.0	5.50
A7777/32	7/32	5.56	0.2188	57.0	93.0	5.56
A7775.6	–	5.60	0.2205	57.0	93.0	5.60
A7775.7	–	5.70	0.2244	57.0	93.0	5.70
A7775.8	–	5.80	0.2283	57.0	93.0	5.80
A7775.9	–	5.90	0.2323	57.0	93.0	5.90
A77715/64	15/64	5.95	0.2344	57.0	93.0	5.95
A7776.0	–	6.00	0.2362	57.0	93.0	6.00
A7776.1	–	6.10	0.2402	63.0	101.0	6.10
A7776.2	–	6.20	0.2441	63.0	101.0	6.20
A7776.3	–	6.30	0.2480	63.0	101.0	6.30
A7771/4	1/4	6.35	0.2500	63.0	101.0	6.35
A7776.4	–	6.40	0.2520	63.0	101.0	6.40
A7776.5	–	6.50	0.2559	63.0	101.0	6.50
A7776.6	–	6.60	0.2598	63.0	101.0	6.60
A7776.7	–	6.70	0.2638	63.0	101.0	6.70
A77717/64	17/64	6.75	0.2656	69.0	109.0	6.75
A7776.8	–	6.80	0.2677	69.0	109.0	6.80
A7776.9	–	6.90	0.2717	69.0	109.0	6.90
A7777.0	–	7.00	0.2756	69.0	109.0	7.00
A7777.1	–	7.10	0.2795	69.0	109.0	7.10
A7779/32	9/32	7.14	0.2813	69.0	109.0	7.14
A7777.2	–	7.20	0.2835	69.0	109.0	7.20
A7777.3	–	7.30	0.2874	69.0	109.0	7.30
A7777.4	–	7.40	0.2913	69.0	109.0	7.40
A7777.5	–	7.50	0.2953	69.0	109.0	7.50
A77719/64	19/64	7.54	0.2969	75.0	117.0	7.54
A7777.6	–	7.60	0.2992	75.0	117.0	7.60
A7777.7	–	7.70	0.3031	75.0	117.0	7.70
A7777.8	–	7.80	0.3071	75.0	117.0	7.80
A7777.9	–	7.90	0.3110	75.0	117.0	7.90
A7775/16	5/16	7.94	0.3125	75.0	117.0	7.94
A7778.0	–	8.00	0.3150	75.0	117.0	8.00

Produkt	DC	DC	DC	LCF	OAL	D CON MS
	(inch)	(mm)	(inch)	(mm)	(mm)	(mm)
A7778.1	–	8.10	0.3189	75.0	117.0	8.10
A7778.2	–	8.20	0.3228	75.0	117.0	8.20
A7778.3	–	8.30	0.3268	75.0	117.0	8.30
A77721/64	21/64	8.33	0.3281	75.0	117.0	8.33
A7778.4	–	8.40	0.3307	75.0	117.0	8.40
A7778.5	–	8.50	0.3346	75.0	117.0	8.50
A7778.6	–	8.60	0.3386	81.0	125.0	8.60
A7778.7	–	8.70	0.3425	81.0	125.0	8.70
A77711/32	11/32	8.73	0.3438	81.0	125.0	8.73
A7778.8	–	8.80	0.3465	81.0	125.0	8.80
A7778.9	–	8.90	0.3504	81.0	125.0	8.90
A7779.0	–	9.00	0.3543	81.0	125.0	9.00
A7779.1	–	9.10	0.3583	81.0	125.0	9.10
A77723/64	23/64	9.13	0.3594	81.0	125.0	9.13
A7779.2	–	9.20	0.3622	81.0	125.0	9.20
A7779.3	–	9.30	0.3661	81.0	125.0	9.30
A7779.4	–	9.40	0.3701	81.0	125.0	9.40
A7779.5	–	9.50	0.3740	81.0	125.0	9.50
A7773/8	3/8	9.52	0.3750	87.0	133.0	9.52
A7779.6	–	9.60	0.3780	87.0	133.0	9.60
A7779.7	–	9.70	0.3819	87.0	133.0	9.70
A7779.8	–	9.80	0.3858	87.0	133.0	9.80
A7779.9	–	9.90	0.3898	87.0	133.0	9.90
A77725/64	25/64	9.92	0.3906	87.0	133.0	9.92
A77710.0	–	10.00	0.3937	87.0	133.0	10.00
A77710.1	–	10.10	0.3976	87.0	133.0	10.10
A77710.2	–	10.20	0.4016	87.0	133.0	10.20
A77713/32	13/32	10.32	0.4063	87.0	133.0	10.32
A77710.5	–	10.50	0.4134	87.0	133.0	10.50
A77727/64	27/64	10.72	0.4219	94.0	142.0	10.72
A77710.8	–	10.80	0.4252	94.0	142.0	10.80
A77711.0	–	11.00	0.4331	94.0	142.0	11.00
A7777/16	7/16	11.11	0.4375	94.0	142.0	11.11
A77711.2	–	11.20	0.4409	94.0	142.0	11.20
A77711.5	–	11.50	0.4528	94.0	142.0	11.50
A77729/64	29/64	11.51	0.4531	94.0	142.0	11.51
A77711.8	–	11.80	0.4646	94.0	142.0	11.80
A77715/32	15/32	11.91	0.4688	101.0	151.0	11.91
A77712.0	–	12.00	0.4724	101.0	151.0	12.00
A77712.2	–	12.20	0.4803	101.0	151.0	12.20
A77731/64	31/64	12.30	0.4844	101.0	151.0	12.30
A77712.5	–	12.50	0.4921	101.0	151.0	12.50
A7771/2	1/2	12.70	0.5000	101.0	151.0	12.70
A77712.8	–	12.80	0.5039	101.0	151.0	12.80
A77713.0	–	13.00	0.5118	101.0	151.0	13.00
A77713.5	–	13.50	0.5315	108.0	160.0	13.50
A77714.0	–	14.00	0.5512	108.0	160.0	14.00
A77714.5	–	14.50	0.5709	114.0	169.0	14.50
A77715.0	–	15.00	0.5906	114.0	169.0	15.00
A77715.5	–	15.50	0.6102	120.0	178.0	15.50
A77716.0	–	16.00	0.6299	120.0	178.0	16.00



A160



HSS Vrták s naletovanou karbidovou špičkou, Parní temperace povrchu

HSS dřík vrtáku a pájené SK břity dodávají vysoký výkon jako u karbidového nástroje. Tělo vrtáku je pevné a méně křehké. Vrcholový úhel 118° a konstrukce se 4 fazetkami napomáhá vystředění a usnadňuje přebroušování. Ekonomická volba zejména pro vrtání litin. Pro použití na CNC i konvenčních strojích.

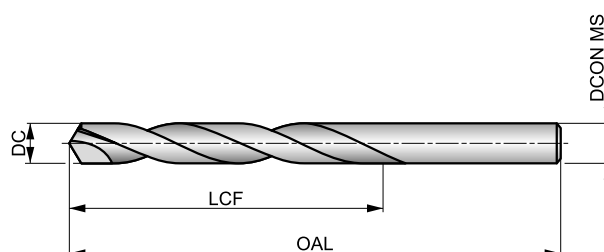

HSS HM	DIN 338	4×D
118°	Bright ST	
λ 20-35°	R	DC h8

Skupiny obráběných materiálů, startovní řezná rychlost (Vc m/min) a kód posuvu. Tabulku s posuvem na otáčku naleznete od strany 175.

P1.1 73 E	P1.2 82 E	P1.3 85 E	P2.1 63 E	P2.2 55 D	P2.3 49 C	P3.1 59 D	P3.2 47 D	P3.3 40 C	P4.1 35 D	P4.2 30 C	P4.3 24 A	M1.1 55 B	M1.2 46 B
M2.1 49 B	M2.2 40 B	M3.1 41 C	M3.2 35 C	M3.3 32 C	M4.1 35 A	K1.1 50 C	K1.2 37 A	K1.3 28 A	K2.1 43 A	K2.2 35 A	K2.3 28 A	K3.1 38 A	K3.2 29 A
K3.3 24 A	K4.1 35 A	K4.2 27 A	K4.3 20 A	K4.4 17 A	K4.5 14 A	K5.1 40 A	K5.2 30 A	K5.3 23 A	N1.1 50 I	N1.2 38 I	N1.3 25 H	N2.1 62 G	N2.2 55 G
N2.3 40 G	N3.1 119 C	N3.2 70 G	N3.3 35 D	N4.2 60 E	S1.1 35 A	S1.2 35 A	S1.3 25 A	S2.1 33 A	S2.2 28 A	S3.1 25 A	S3.2 20 A	S4.1 20 A	S4.2 16 A

Produkt	DC	DC	LCF	OAL	DCON MS
	(mm)	(inch)			
A1604.0	4.00	0.1575	43.0	75.0	4.00
A1604.5	4.50	0.1772	47.0	80.0	4.50
A1605.0	5.00	0.1969	52.0	86.0	5.00
A1605.5	5.50	0.2165	57.0	93.0	5.50
A1606.0	6.00	0.2362	57.0	93.0	6.00
A1606.5	6.50	0.2559	63.0	101.0	6.50
A1606.8	6.80	0.2677	69.0	109.0	6.80
A1607.0	7.00	0.2756	69.0	109.0	7.00
A1607.5	7.50	0.2953	69.0	109.0	7.50
A1608.0	8.00	0.3150	75.0	117.0	8.00
A1608.5	8.50	0.3346	75.0	117.0	8.50
A1609.0	9.00	0.3543	81.0	125.0	9.00
A1609.5	9.50	0.3740	81.0	125.0	9.50
A16010.0	10.00	0.3937	87.0	133.0	10.00
A16010.2	10.20	0.4016	87.0	133.0	10.20
A16010.5	10.50	0.4134	87.0	133.0	10.50
A16011.0	11.00	0.4331	94.0	142.0	11.00
A16011.5	11.50	0.4528	94.0	142.0	11.50
A16012.0	12.00	0.4724	101.0	151.0	12.00
A16013.0	13.00	0.5118	101.0	151.0	13.00
A16014.0	14.00	0.5512	108.0	160.0	14.00
A16015.0	15.00	0.5906	114.0	169.0	15.00
A16016.0	16.00	0.6299	120.0	178.0	16.00



A510

ADX HSS Vrták, Povlakovaný TiN

Produktivní vrták pro kvalitní a přesné otvory, vhodný pro vysoké řezné rychlosti a velké posuvy (tolerance otvorů H9). Vrcholový úhel 130°, příčné ostří usnadňuje vystředění a snižuje řezné síly. Tento vrták by měl být používán na strojích s konstantním posuvem. Povlak TiN zvyšuje produktivitu a prodlužuje životnost.



ADX

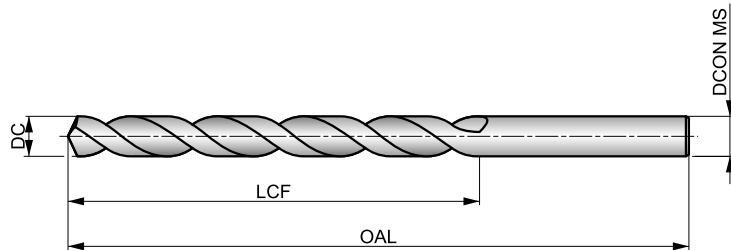

HSS	DIN 338	4xD
130°	TiN	
λ 32-40°	R	DC h8

Skupiny obráběných materiálů, startovní řezná rychlost (Vc m/min) a kód posuvu. Tabulku s posuvem na otáčku naleznete od strany 175.

P1.1 ■ 53 M	P1.2 ■ 59 M	P1.3 ■ 61 M	P2.1 ■ 45 M	P2.2 ■ 40 K	P2.3 ■ 35 F	P3.1 ■ 31 H	P3.2 ■ 25 H	P3.3 ■ 21 F	P4.1 ■ 19 H	P4.2 ■ 16 F	P4.3 ■ 13 D	M1.1 ■ 38 G	M1.2 ■ 32 G
M2.1 ■ 34 G	M2.2 ■ 28 G	M3.1 ■ 16 I	M3.2 ■ 14 I	M3.3 ■ 13 I	M4.1 ■ 19 G	K1.1 ■ 42 K	K1.2 ■ 31 J	K1.3 ■ 23 J	K2.1 ■ 34 J	K2.2 ■ 28 J	K2.3 ■ 22 F	K3.1 ■ 30 J	K3.2 ■ 23 J
K3.3 ■ 19 F	K4.1 ■ 28 J	K4.2 ■ 21 J	K4.3 ■ 16 F	K4.4 ■ 13 F	K4.5 ■ 11 F	K5.1 ■ 32 J	K5.2 ■ 24 J	K5.3 ■ 19 F	N1.1 ■ 50 G	N1.2 ■ 38 G	N1.3 ■ 25 M	N2.1 ■ 48 I	N2.2 ■ 43 I
N2.3 ■ 31 I	N3.1 ■ 85 I	N3.2 ■ 50 I	N3.3 ■ 25 D	N4.1 ■ 65 G	N4.2 ■ 50 G	N4.3 ■ 35 F	S1.1 ■ 32 G	S1.2 ■ 20 H	S1.3 ■ 4 B	S2.1 ■ 12 E	S2.2 ■ 8 E	S3.1 ■ 9 E	S3.2 ■ 6 E
S4.1 ■ 7 E	S4.2 ■ 5 E												

Produkt	DC (inch)	DC (mm)	DC (inch)	LCF (mm)	OAL (mm)	DCON MS (mm)
A5103.0	–	3.00	0.1181	33.0	61.0	3.00
A5103.1	–	3.10	0.1220	36.0	65.0	3.10
A5101/8	1/8	3.18	0.1250	36.0	65.0	3.18
A5103.2	–	3.20	0.1260	36.0	65.0	3.20
A5103.3	–	3.30	0.1299	36.0	65.0	3.30
A5103.4	–	3.40	0.1339	39.0	70.0	3.40
A5103.5	–	3.50	0.1378	39.0	70.0	3.50
A5109/64	9/64	3.57	0.1406	39.0	70.0	3.57
A5103.6	–	3.60	0.1417	39.0	70.0	3.60
A5103.7	–	3.70	0.1457	39.0	70.0	3.70
A5103.8	–	3.80	0.1496	43.0	75.0	3.80
A5103.9	–	3.90	0.1535	43.0	75.0	3.90
A5105/32	5/32	3.97	0.1563	43.0	75.0	3.97
A5104.0	–	4.00	0.1575	43.0	75.0	4.00
A5104.1	–	4.10	0.1614	43.0	75.0	4.10
A5104.2	–	4.20	0.1654	43.0	75.0	4.20
A5104.3	–	4.30	0.1693	47.0	80.0	4.30
A51011/64	11/64	4.37	0.1719	47.0	80.0	4.37
A5104.4	–	4.40	0.1732	47.0	80.0	4.40
A5104.5	–	4.50	0.1772	47.0	80.0	4.50
A5104.6	–	4.60	0.1811	47.0	80.0	4.60
A5104.7	–	4.70	0.1850	47.0	80.0	4.70
A5103/16	3/16	4.76	0.1875	52.0	86.0	4.76
A5104.8	–	4.80	0.1890	52.0	86.0	4.80

Produkt	DC (inch)	DC (mm)	DC (inch)	LCF (mm)	OAL (mm)	DCON MS (mm)
A5104.9	–	4.90	0.1929	52.0	86.0	4.90
A5105.0	–	5.00	0.1969	52.0	86.0	5.00
A5105.1	–	5.10	0.2008	52.0	86.0	5.10
A51013/64	13/64	5.16	0.2031	52.0	86.0	5.16
A5105.2	–	5.20	0.2047	52.0	86.0	5.20
A5105.3	–	5.30	0.2087	52.0	86.0	5.30
A5105.4	–	5.40	0.2126	57.0	93.0	5.40
A5105.5	–	5.50	0.2165	57.0	93.0	5.50
A5107/32	7/32	5.56	0.2188	57.0	93.0	5.56
A5105.6	–	5.60	0.2205	57.0	93.0	5.60
A5105.7	–	5.70	0.2244	57.0	93.0	5.70
A5105.8	–	5.80	0.2283	57.0	93.0	5.80
A5105.9	–	5.90	0.2323	57.0	93.0	5.90
A51015/64	15/64	5.95	0.2344	57.0	93.0	5.95
A5106.0	–	6.00	0.2362	57.0	93.0	6.00
A5106.1	–	6.10	0.2402	63.0	101.0	6.10
A5106.2	–	6.20	0.2441	63.0	101.0	6.20
A5106.3	–	6.30	0.2480	63.0	101.0	6.30
A5101/4	1/4	6.35	0.2500	63.0	101.0	6.35
A5106.4	–	6.40	0.2520	63.0	101.0	6.40
A5106.5	–	6.50	0.2559	63.0	101.0	6.50
A5106.6	–	6.60	0.2598	63.0	101.0	6.60
A5106.7	–	6.70	0.2638	63.0	101.0	6.70
A51017/64	17/64	6.75	0.2656	69.0	109.0	6.75



Produkt	DC	DC	DC	LCF	OAL	D CON MS
	(inch)	(mm)	(inch)	(mm)	(mm)	(mm)
A5106.8	–	6.80	0.2677	69.0	109.0	6.80
A5106.9	–	6.90	0.2717	69.0	109.0	6.90
A5107.0	–	7.00	0.2756	69.0	109.0	7.00
A5107.1	–	7.10	0.2795	69.0	109.0	7.10
A5109/32	9/32	7.14	0.2813	69.0	109.0	7.14
A5107.2	–	7.20	0.2835	69.0	109.0	7.20
A5107.3	–	7.30	0.2874	69.0	109.0	7.30
A5107.4	–	7.40	0.2913	69.0	109.0	7.40
A5107.5	–	7.50	0.2953	69.0	109.0	7.50
A51019/64	19/64	7.54	0.2969	75.0	117.0	7.54
A5107.6	–	7.60	0.2992	75.0	117.0	7.60
A5107.7	–	7.70	0.3031	75.0	117.0	7.70
A5107.8	–	7.80	0.3071	75.0	117.0	7.80
A5107.9	–	7.90	0.3110	75.0	117.0	7.90
A5105/16	5/16	7.94	0.3125	75.0	117.0	7.94
A5108.0	–	8.00	0.3150	75.0	117.0	8.00
A5108.1	–	8.10	0.3189	75.0	117.0	8.10
A5108.2	–	8.20	0.3228	75.0	117.0	8.20
A5108.3	–	8.30	0.3268	75.0	117.0	8.30
A51021/64	21/64	8.33	0.3281	75.0	117.0	8.33
A5108.4	–	8.40	0.3307	75.0	117.0	8.40
A5108.5	–	8.50	0.3346	75.0	117.0	8.50
A5108.6	–	8.60	0.3386	81.0	125.0	8.60
A5108.7	–	8.70	0.3425	81.0	125.0	8.70
A51011/32	11/32	8.73	0.3438	81.0	125.0	8.73
A5108.8	–	8.80	0.3465	81.0	125.0	8.80
A5108.9	–	8.90	0.3504	81.0	125.0	8.90
A5109.0	–	9.00	0.3543	81.0	125.0	9.00
A5109.1	–	9.10	0.3583	81.0	125.0	9.10
A51023/64	23/64	9.13	0.3594	81.0	125.0	9.13
A5109.2	–	9.20	0.3622	81.0	125.0	9.20
A5109.3	–	9.30	0.3661	81.0	125.0	9.30
A5109.4	–	9.40	0.3701	81.0	125.0	9.40
A5109.5	–	9.50	0.3740	81.0	125.0	9.50
A5103/8	3/8	9.52	0.3750	87.0	133.0	9.52
A5109.6	–	9.60	0.3780	87.0	133.0	9.60
A5109.7	–	9.70	0.3819	87.0	133.0	9.70
A5109.8	–	9.80	0.3858	87.0	133.0	9.80
A5109.9	–	9.90	0.3898	87.0	133.0	9.90
A51025/64	25/64	9.92	0.3906	87.0	133.0	9.92

Produkt	DC	DC	DC	LCF	OAL	D CON MS
	(inch)	(mm)	(inch)	(mm)	(mm)	(mm)
A51010.0	–	10.00	0.3937	87.0	133.0	10.00
A51010.1	–	10.10	0.3976	87.0	133.0	10.10
A51010.2	–	10.20	0.4016	87.0	133.0	10.20
A51010.3	–	10.30	0.4055	87.0	133.0	10.30
A51013/32	13/32	10.32	0.4063	87.0	133.0	10.32
A51010.4	–	10.40	0.4094	87.0	133.0	10.40
A51010.5	–	10.50	0.4134	87.0	133.0	10.50
A51010.6	–	10.60	0.4173	87.0	133.0	10.60
A51010.7	–	10.70	0.4213	94.0	142.0	10.70
A51027/64	27/64	10.72	0.4219	94.0	142.0	10.72
A51010.8	–	10.80	0.4252	94.0	142.0	10.80
A51010.9	–	10.90	0.4291	94.0	142.0	10.90
A51011.0	–	11.00	0.4331	94.0	142.0	11.00
A51011.1	–	11.10	0.4370	94.0	142.0	11.10
A5107/16	7/16	11.11	0.4375	94.0	142.0	11.11
A51011.2	–	11.20	0.4409	94.0	142.0	11.20
A51011.3	–	11.30	0.4449	94.0	142.0	11.30
A51011.4	–	11.40	0.4488	94.0	142.0	11.40
A51011.5	–	11.50	0.4528	94.0	142.0	11.50
A51029/64	29/64	11.51	0.4531	94.0	142.0	11.51
A51011.6	–	11.60	0.4567	94.0	142.0	11.60
A51011.7	–	11.70	0.4606	94.0	142.0	11.70
A51011.8	–	11.80	0.4646	94.0	142.0	11.80
A51011.9	–	11.90	0.4685	101.0	151.0	11.90
A51015/32	15/32	11.91	0.4688	101.0	151.0	11.91
A51012.0	–	12.00	0.4724	101.0	151.0	12.00
A51012.1	–	12.10	0.4764	101.0	151.0	12.10
A51012.2	–	12.20	0.4803	101.0	151.0	12.20
A51012.3	–	12.30	0.4843	101.0	151.0	12.30
A51031/64	31/64	12.30	0.4844	101.0	151.0	12.30
A51012.4	–	12.40	0.4882	101.0	151.0	12.40
A51012.5	–	12.50	0.4921	101.0	151.0	12.50
A51012.6	–	12.60	0.4961	101.0	151.0	12.60
A51012.7	–	12.70	0.5000	101.0	151.0	12.70
A5101/2	1/2	12.70	0.5000	101.0	151.0	12.70
A51012.8	–	12.80	0.5039	101.0	151.0	12.80
A51012.9	–	12.90	0.5079	101.0	151.0	12.90
A51013.0	–	13.00	0.5118	101.0	151.0	13.00
A51014.0	–	14.00	0.5512	108.0	160.0	14.00



A553



ADX HSS-E (5 % kobaltu) Vrták s vnitřním chlazením, Povlakovaný TiAlN

Produktivní vrták pro kvalitní a přesné otvory, vhodný pro vysoké řezné rychlosti a velké posuvy (tolerance otvorů H9). Vrcholový úhel 130° a povlak TiAlN zvyšuje tvrdost povrchu nástroje a prodlužuje životnost. Tento nástroj by měl být nasazen pouze na CNC strojích. Vhodný pro širokou oblast obráběných materiálů.

ADX

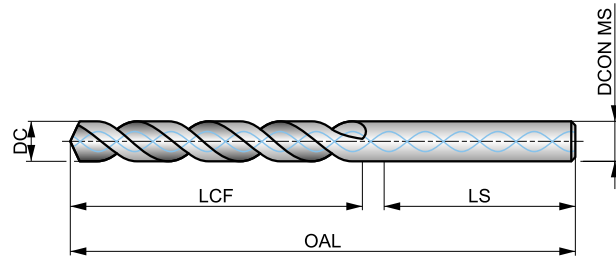

HSS-E	DORMER	5xD
130°	TiAlN Top	DIN 6535HA
$\lambda > 35^\circ$	R	
DC h8		

Skupiny obráběných materiálů, startovní řezná rychlost (Vc m/min) a kód posuvu. Tabulku s posuvem na otáčku naleznete od strany 175.

P1.1 ■ 80 L	P1.2 ■ 89 L	P1.3 ■ 92 L	P2.1 ■ 68 L	P2.2 ■ 60 L	P2.3 ■ 53 F	P3.1 ■ 41 H	P3.2 ■ 33 H	P3.3 ■ 28 F	P4.1 ■ 25 H	P4.2 ■ 21 F	P4.3 ■ 17 D	M1.1 ■ 55 G	M1.2 ■ 46 G
M2.1 ■ 49 G	M2.2 ■ 40 G	M3.1 ■ 22 I	M3.2 ■ 19 I	M3.3 ■ 17 I	M4.1 ■ 27 G	K1.1 ■ 70 K	K1.2 ■ 52 J	K1.3 ■ 39 J	K2.1 ■ 55 J	K2.2 ■ 45 J	K2.3 ■ 36 F	K3.1 ■ 49 J	K3.2 ■ 37 J
K3.3 ■ 30 F	K4.1 ■ 45 J	K4.2 ■ 34 J	K4.3 ■ 25 F	K4.4 ■ 22 F	K4.5 ■ 18 F	K5.1 ■ 51 J	K5.2 ■ 39 J	K5.3 ■ 30 F	N1.1 ■ 70 H	N1.2 ■ 53 H	N1.3 ■ 35 M	N2.1 ■ 85 I	N2.2 ■ 76 I
N2.3 ■ 55 I	N3.1 ■ 144 I	N3.2 ■ 85 I	N3.3 ■ 43 G	N4.1 ■ 90 G	S1.1 ■ 45 G	S1.2 ■ 30 E	S1.3 ■ 8 C	S2.1 ■ 20 E	S2.2 ■ 14 G	S3.1 ■ 15 E	S3.2 ■ 10 G	S4.1 ■ 12 E	S4.2 ■ 8 G

DCON MS v toleranci h6.

Produkt	DC		LCF	OAL	LS	DCON MS	Produkt	DC		LCF	OAL	LS	DCON MS
	(mm)	(inch)						(mm)	(inch)				
A5535.0	5.00	0.1969	36.0	79.0	36.0	6.00	A55311.3	11.30	0.4449	94.0	150.0	45.0	12.00
A5535.2	5.20	0.2047	38.0	79.0	36.0	6.00	A55311.5	11.50	0.4528	94.0	150.0	45.0	12.00
A5535.5	5.50	0.2165	40.0	79.0	36.0	6.00	A55312.0	12.00	0.4724	94.0	150.0	45.0	12.00
A5536.0	6.00	0.2362	43.0	79.0	36.0	6.00	A55312.5	12.50	0.4921	101.0	160.0	45.0	14.00
A5536.3	6.30	0.2480	46.0	87.0	36.0	8.00	A55313.0	13.00	0.5118	101.0	160.0	45.0	14.00
A5536.5	6.50	0.2559	47.0	87.0	36.0	8.00	A55313.5	13.50	0.5315	101.0	160.0	45.0	14.00
A5536.8	6.80	0.2677	48.0	87.0	36.0	8.00	A55314.0	14.00	0.5512	101.0	160.0	45.0	14.00
A5536.9	6.90	0.2717	48.0	87.0	36.0	8.00	A55314.25	14.25	0.5610	108.0	170.0	48.0	16.00
A5537.0	7.00	0.2756	48.0	87.0	36.0	8.00	A55314.5	14.50	0.5709	108.0	170.0	48.0	16.00
A5537.4	7.40	0.2913	54.0	94.0	36.0	8.00	A55315.0	15.00	0.5906	108.0	170.0	48.0	16.00
A5537.5	7.50	0.2953	54.0	94.0	36.0	8.00	A55315.25	15.25	0.6004	108.0	170.0	48.0	16.00
A5538.0	8.00	0.3150	58.0	94.0	36.0	8.00	A55315.5	15.50	0.6102	108.0	170.0	48.0	16.00
A5538.5	8.50	0.3346	75.0	130.0	40.0	10.00	A55316.0	16.00	0.6299	108.0	170.0	48.0	16.00
A5538.7	8.70	0.3425	75.0	130.0	40.0	10.00	A55316.5	16.50	0.6496	125.0	190.0	48.0	18.00
A5539.0	9.00	0.3543	75.0	130.0	40.0	10.00	A55317.0	17.00	0.6693	125.0	190.0	48.0	18.00
A5539.5	9.50	0.3740	75.0	130.0	40.0	10.00	A55317.5	17.50	0.6890	130.0	190.0	48.0	18.00
A55310.0	10.00	0.3937	75.0	130.0	40.0	10.00	A55317.75	17.75	0.6988	130.0	190.0	48.0	18.00
A55310.2	10.20	0.4016	87.0	150.0	45.0	12.00	A55318.0	18.00	0.7087	130.0	190.0	48.0	18.00
A55310.3	10.30	0.4055	87.0	150.0	45.0	12.00	A55319.0	19.00	0.7480	135.0	200.0	50.0	20.00
A55310.5	10.50	0.4134	87.0	150.0	45.0	12.00	A55319.25	19.25	0.7579	140.0	200.0	50.0	20.00
A55311.0	11.00	0.4331	94.0	150.0	45.0	12.00	A55320.0	20.00	0.7874	140.0	200.0	50.0	20.00



A900



PFX HSS-E (5 % kobaltu) Vrták, Leštěný

Produktivní vrták pro kvalitní a přesné otvory, vhodný pro vysoké řezné rychlosti a velké posuvy (tolerance otvorů H10). Vrcholový úhel 130° a speciální parabolická drážka usnadňuje vrtání hlubokých otvorů v jednom kroku. Vhodný pro širokou oblast obráběných materiálů.



PFX

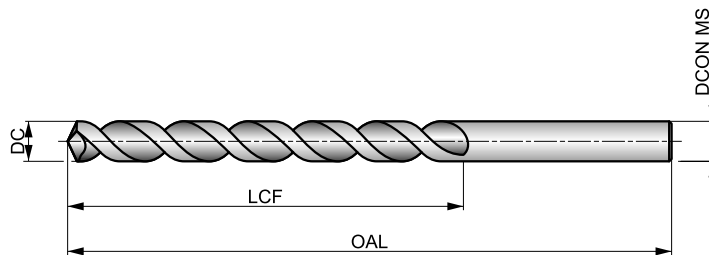

HSS-E	DIN ANSI	6×D
130°	Bright	
λ>35°	R	DC h8

Skupiny obráběných materiálů, startovní řezná rychlost (Vc m/min) a kód posuvu. Tabulku s posuvem na otáčku naleznete od strany 175.

P1.1 ■ 34 H	P1.2 ■ 39 H	P1.3 ■ 40 H	P2.1 ■ 30 H	P2.2 ■ 26 H	P2.3 ■ 23 E	P3.1 ■ 31 H	P3.2 ■ 25 H	P3.3 ■ 21 E	P4.1 ■ 19 H	P4.2 ■ 16 E	P4.3 ■ 13 E	M1.1 ■ 21 E	M1.2 ■ 17 E
M2.1 ■ 18 E	M2.2 ■ 15 E	M3.1 ■ 8 E	M3.2 ■ 7 E	M3.3 ■ 6 E	M4.1 ■ 9 C	K1.1 ■ 24 J	K1.2 ■ 18 J	K1.3 ■ 13 J	K2.1 ■ 23 J	K2.2 ■ 19 J	K2.3 ■ 15 I	K3.1 ■ 21 J	K3.2 ■ 16 J
K3.3 ■ 13 I	K4.1 ■ 19 J	K4.2 ■ 14 J	K4.3 ■ 11 I	K4.4 ■ 9 I	K4.5 ■ 8 I	K5.1 ■ 22 J	K5.2 ■ 16 J	K5.3 ■ 13 I	N1.1 ■ 60 J	N1.2 ■ 45 J	N1.3 ■ 30 N	N2.1 ■ 62 N	N2.2 ■ 55 N
N2.3 ■ 40 N	N3.1 ■ 90 H	N3.2 ■ 53 I	N3.3 ■ 27 G	N4.1 ■ 55 I	N4.2 ■ 40 G	S1.1 ■ 22 E	S1.2 ■ 15 E	S1.3 ■ 6 C	S2.1 ■ 9 G	S2.2 ■ 8 C	S3.1 ■ 7 G	S3.2 ■ 6 C	S4.1 ■ 5 G
S4.2 ■ 5 C													

Produkt	DC (inch)	DC (mm)	DC (inch)	LCF (mm)	OAL (mm)	DCON MS (mm)
A9001.0	–	1.00	0.0394	12.0	34.0	1.00
A9001.1	–	1.10	0.0433	14.0	36.0	1.10
A9003/64	3/64	1.19	0.0469	19.0	44.0	1.19
A9001.2	–	1.20	0.0472	16.0	38.0	1.20
A9001.25	–	1.25	0.0492	16.0	36.0	1.25
A9001.3	–	1.30	0.0512	16.0	38.0	1.30
A9001.4	–	1.40	0.0551	18.0	40.0	1.40
A9001.5	–	1.50	0.0591	18.0	40.0	1.50
A9001.55	–	1.55	0.0610	20.0	43.0	1.55
A9001/16	1/16	1.59	0.0625	22.0	48.0	1.59
A9001.6	–	1.60	0.0630	20.0	43.0	1.60
A9001.7	–	1.70	0.0669	20.0	43.0	1.70
A9001.75	–	1.75	0.0689	22.0	46.0	1.75
A9001.8	–	1.80	0.0709	22.0	46.0	1.80
A9001.9	–	1.90	0.0748	22.0	46.0	1.90
A9005/64	5/64	1.98	0.0781	25.0	51.0	1.98
A9002.0	–	2.00	0.0787	24.0	49.0	2.00
A9002.1	–	2.10	0.0827	24.0	49.0	2.10
A9002.15	–	2.15	0.0846	27.0	53.0	2.15
A9002.2	–	2.20	0.0866	27.0	53.0	2.20
A9002.3	–	2.30	0.0906	27.0	53.0	2.30
A9003/32	3/32	2.38	0.0937	32.0	57.0	2.38
A9002.4	–	2.40	0.0945	30.0	57.0	2.40
A9002.5	–	2.50	0.0984	30.0	57.0	2.50

Produkt	DC (inch)	DC (mm)	DC (inch)	LCF (mm)	OAL (mm)	DCON MS (mm)
A9002.6	–	2.60	0.1024	30.0	57.0	2.60
A9002.7	–	2.70	0.1063	33.0	61.0	2.70
A9007/64	7/64	2.78	0.1094	38.0	67.0	2.78
A9002.8	–	2.80	0.1102	33.0	61.0	2.80
A9002.9	–	2.90	0.1142	33.0	61.0	2.90
A9003.0	–	3.00	0.1181	33.0	61.0	3.00
A9003.1	–	3.10	0.1220	36.0	65.0	3.10
A9001/8	1/8	3.18	0.1250	41.0	70.0	3.18
A9003.2	–	3.20	0.1260	36.0	65.0	3.20
A9003.3	–	3.30	0.1299	36.0	65.0	3.30
A9003.4	–	3.40	0.1339	39.0	70.0	3.40
A9003.5	–	3.50	0.1378	39.0	70.0	3.50
A9009/64	9/64	3.57	0.1406	44.0	73.0	3.57
A9003.6	–	3.60	0.1417	39.0	70.0	3.60
A9003.7	–	3.70	0.1457	39.0	70.0	3.70
A9003.8	–	3.80	0.1496	43.0	75.0	3.80
A9003.9	–	3.90	0.1535	43.0	75.0	3.90
A9005/32	5/32	3.97	0.1563	51.0	79.0	3.97
A9004.0	–	4.00	0.1575	43.0	75.0	4.00
A9004.1	–	4.10	0.1614	43.0	75.0	4.10
A9004.2	–	4.20	0.1654	43.0	75.0	4.20
A9004.3	–	4.30	0.1693	47.0	80.0	4.30
A90011/64	11/64	4.37	0.1719	54.0	83.0	4.37
A9004.4	–	4.40	0.1732	47.0	80.0	4.40



Produkt	DC	DC	DC	LCF	OAL	D CON MS
	(inch)	(mm)	(inch)	(mm)	(mm)	(mm)
A9004.5	–	4.50	0.1772	47.0	80.0	4.50
A9004.6	–	4.60	0.1811	47.0	80.0	4.60
A9004.7	–	4.70	0.1850	47.0	80.0	4.70
A9003/16	3/16	4.76	0.1875	59.0	89.0	4.76
A9004.8	–	4.80	0.1890	52.0	86.0	4.80
A9004.9	–	4.90	0.1929	52.0	86.0	4.90
A9005.0	–	5.00	0.1969	52.0	86.0	5.00
A9005.1	–	5.10	0.2008	52.0	86.0	5.10
A90013/64	13/64	5.16	0.2031	62.0	92.0	5.16
A9005.2	–	5.20	0.2047	52.0	86.0	5.20
A9005.3	–	5.30	0.2087	52.0	86.0	5.30
A9005.4	–	5.40	0.2126	57.0	93.0	5.40
A9005.5	–	5.50	0.2165	57.0	93.0	5.50
A9007/32	7/32	5.56	0.2188	64.0	95.0	5.56
A9005.6	–	5.60	0.2205	57.0	93.0	5.60
A9005.7	–	5.70	0.2244	57.0	93.0	5.70
A9005.8	–	5.80	0.2283	57.0	93.0	5.80
A9005.9	–	5.90	0.2323	57.0	93.0	5.90
A90015/64	15/64	5.95	0.2344	67.0	98.0	5.95
A9006.0	–	6.00	0.2362	57.0	93.0	6.00
A9006.1	–	6.10	0.2402	63.0	101.0	6.10
A9006.2	–	6.20	0.2441	63.0	101.0	6.20
A9006.3	–	6.30	0.2480	63.0	101.0	6.30
A9001/4	1/4	6.35	0.2500	70.0	102.0	6.35
A9006.4	–	6.40	0.2520	63.0	101.0	6.40
A9006.5	–	6.50	0.2559	63.0	101.0	6.50
A9006.6	–	6.60	0.2598	63.0	101.0	6.60
A9006.7	–	6.70	0.2638	63.0	101.0	6.70
A90017/64	17/64	6.75	0.2656	73.0	105.0	6.75
A9006.8	–	6.80	0.2677	69.0	109.0	6.80
A9006.9	–	6.90	0.2717	69.0	109.0	6.90
A9007.0	–	7.00	0.2756	69.0	109.0	7.00
A9007.1	–	7.10	0.2795	69.0	109.0	7.10
A9009/32	9/32	7.14	0.2813	75.0	108.0	7.14
A9007.2	–	7.20	0.2835	69.0	109.0	7.20
A9007.3	–	7.30	0.2874	69.0	109.0	7.30
A9007.4	–	7.40	0.2913	69.0	109.0	7.40
A9007.5	–	7.50	0.2953	69.0	109.0	7.50
A90019/64	19/64	7.54	0.2969	78.0	111.0	7.54
A9007.6	–	7.60	0.2992	75.0	117.0	7.60
A9007.7	–	7.70	0.3031	75.0	117.0	7.70
A9007.8	–	7.80	0.3071	75.0	117.0	7.80
A9007.9	–	7.90	0.3110	75.0	117.0	7.90
A9005/16	5/16	7.94	0.3125	81.0	114.0	7.94
A9008.0	–	8.00	0.3150	75.0	117.0	8.00
A9008.1	–	8.10	0.3189	75.0	117.0	8.10
A9008.2	–	8.20	0.3228	75.0	117.0	8.20
A9008.3	–	8.30	0.3268	75.0	117.0	8.30
A90021/64	21/64	8.33	0.3281	84.0	117.0	8.33
A9008.4	–	8.40	0.3307	75.0	117.0	8.40
A9008.5	–	8.50	0.3346	75.0	117.0	8.50
A9008.6	–	8.60	0.3386	81.0	125.0	8.60
A9008.7	–	8.70	0.3425	81.0	125.0	8.70
A90011/32	11/32	8.73	0.3438	87.0	121.0	8.73
A9008.8	–	8.80	0.3465	81.0	125.0	8.80
A9008.9	–	8.90	0.3504	81.0	125.0	8.90
A9009.0	–	9.00	0.3543	81.0	125.0	9.00
A9009.1	–	9.10	0.3583	81.0	125.0	9.10
A90023/64	23/64	9.13	0.3594	89.0	124.0	9.13
A9009.2	–	9.20	0.3622	81.0	125.0	9.20

Produkt	DC	DC	DC	LCF	OAL	D CON MS
	(inch)	(mm)	(inch)	(mm)	(mm)	(mm)
A9009.3	–	9.30	0.3661	81.0	125.0	9.30
A9009.4	–	9.40	0.3701	81.0	125.0	9.40
A9009.5	–	9.50	0.3740	81.0	125.0	9.50
A9003/8	3/8	9.52	0.3750	92.0	127.0	9.52
A9009.6	–	9.60	0.3780	87.0	133.0	9.60
A9009.7	–	9.70	0.3819	87.0	133.0	9.70
A9009.8	–	9.80	0.3858	87.0	133.0	9.80
A9009.9	–	9.90	0.3898	87.0	133.0	9.90
A90025/64	25/64	9.92	0.3906	95.0	130.0	9.92
A90010.0	–	10.00	0.3937	87.0	133.0	10.00
A90010.2	–	10.20	0.4016	87.0	133.0	10.20
A90010.3	–	10.30	0.4055	87.0	133.0	10.30
A90013/32	13/32	10.32	0.4063	98.0	133.0	10.32
A90010.4	–	10.40	0.4094	87.0	133.0	10.40
A90010.5	–	10.50	0.4134	87.0	133.0	10.50
A90027/64	27/64	10.72	0.4219	100.0	137.0	10.72
A90010.8	–	10.80	0.4252	94.0	142.0	10.80
A90011.0	–	11.00	0.4331	94.0	142.0	11.00
A9007/16	7/16	11.11	0.4375	103.0	140.0	11.11
A90011.5	–	11.50	0.4528	94.0	142.0	11.50
A90029/64	29/64	11.51	0.4531	106.0	143.0	11.51
A90011.8	–	11.80	0.4646	94.0	142.0	11.80
A90015/32	15/32	11.91	0.4688	110.0	146.0	11.91
A90012.0	–	12.00	0.4724	101.0	151.0	12.00
A90031/64	31/64	12.30	0.4844	111.0	149.0	12.30
A90012.5	–	12.50	0.4921	101.0	151.0	12.50
A9001/2	1/2	12.70	0.5000	101.0	151.0	12.70
A90013.0	–	13.00	0.5118	101.0	151.0	13.00
A90033/64	33/64	13.10	0.5156	122.0	168.0	13.10
A90013.5	–	13.50	0.5315	108.0	160.0	13.50
A90035/64	35/64	13.89	0.5469	122.0	168.0	13.89
A90014.0	–	14.00	0.5512	108.0	160.0	14.00
A9009/16	9/16	14.29	0.5625	122.0	168.0	14.29
A90014.5	–	14.50	0.5709	114.0	169.0	14.50
A90037/64	37/64	14.68	0.5781	122.0	168.0	14.68
A90015.0	–	15.00	0.5906	114.0	169.0	15.00
A90019/32	19/32	15.08	0.5938	132.0	181.0	15.08
A90039/64	39/64	15.48	0.6094	132.0	181.0	15.48
A90015.5	–	15.50	0.6102	120.0	178.0	15.50
A9005/8	5/8	15.88	0.6250	132.0	181.0	15.88
A90016.0	–	16.00	0.6299	120.0	178.0	16.00
A90041/64	41/64	16.27	0.6406	132.0	181.0	16.27
A90016.5	–	16.50	0.6496	125.0	184.0	16.50
A90021/32	21/32	16.67	0.6563	132.0	181.0	16.67
A90017.0	–	17.00	0.6693	125.0	184.0	17.00
A90043/64	43/64	17.07	0.6719	143.0	194.0	17.07
A90011/16	11/16	17.46	0.6875	143.0	194.0	17.46
A90017.5	–	17.50	0.6890	130.0	191.0	17.50
A90045/64	45/64	17.86	0.7031	130.0	191.0	17.86
A90018.0	–	18.00	0.7087	130.0	191.0	18.00
A90023/32	23/32	18.26	0.7188	130.0	191.0	18.26
A90018.5	–	18.50	0.7283	135.0	198.0	18.50
A90047/64	47/64	18.65	0.7344	135.0	198.0	18.65
A90019.0	–	19.00	0.7480	135.0	198.0	19.00
A9003/4	3/4	19.05	0.7500	135.0	198.0	19.05
A90049/64	49/64	19.45	0.7656	135.0	198.0	19.45
A90019.5	–	19.50	0.7677	140.0	205.0	19.50
A90025/32	25/32	19.84	0.7813	140.0	205.0	19.84
A90020.0	–	20.00	0.7874	140.0	205.0	20.00



A901



PFX HSS-E (5 % kobaltu) Vrták, Povlak Alcrona

Produktivní vrták pro kvalitní a přesné otvory, vhodný pro vysoké řezné rychlosti a velké posuvy (tolerance otvorů H10). Vrcholový úhel 130° a speciální parabolická drážka. Povlak Alcrona zvyšuje produktivitu a prodlužuje životnost.



PFX

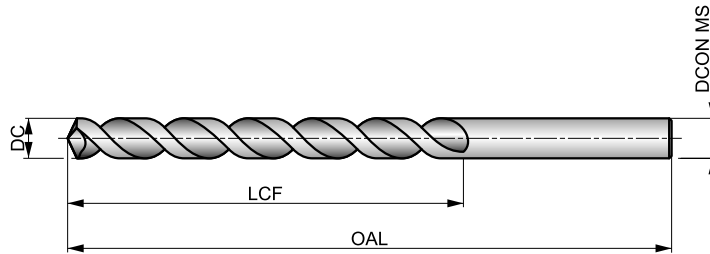

HSS-E	DIN ANSI	6xD
130°	Alcrona Top	
λ > 35°		DC h8

Skupiny obráběných materiálů, startovní řezná rychlost (Vc m/min) a kód posuvu. Tabulku s posuvem na otáčku naleznete od strany 175.

P1.1 ■ 58 J	P1.2 ■ 65 J	P1.3 ■ 68 J	P2.1 ■ 50 J	P2.2 ■ 44 I	P2.3 ■ 39 G	P3.1 ■ 49 I	P3.2 ■ 39 I	P3.3 ■ 33 G	P4.1 ■ 29 I	P4.2 ■ 25 G	P4.3 ■ 20 G	M1.1 ■ 23 E	M1.2 ■ 20 E
M2.1 ■ 21 E	M2.2 ■ 17 E	M3.1 ■ 10 E	M3.2 ■ 9 E	M3.3 ■ 8 E	M4.1 ■ 11 C	K1.1 ■ 58 I	K1.2 ■ 43 I	K1.3 ■ 32 I	K2.1 ■ 42 J	K2.2 ■ 34 J	K2.3 ■ 27 I	K3.1 ■ 37 J	K3.2 ■ 28 J
K3.3 ■ 23 I	K4.1 ■ 34 J	K4.2 ■ 26 J	K4.3 ■ 19 I	K4.4 ■ 16 I	K4.5 ■ 14 I	K5.1 ■ 39 J	K5.2 ■ 29 J	K5.3 ■ 23 I	S1.1 ■ 35 G	S1.2 ■ 24 G	S1.3 ■ 10 E	S2.1 ■ 15 I	S2.2 ■ 14 E
S3.1 ■ 11 I	S3.2 ■ 10 E	S4.1 ■ 9 I	S4.2 ■ 8 E										

Produkt	DC (inch)	DC (mm)	DC (inch)	LCF (mm)	OAL (mm)	DCON MS (mm)
A9011.5	–	1.50	0.0591	18.0	40.0	1.50
A9011.55	–	1.55	0.0610	20.0	43.0	1.55
A9011/16	1/16	1.59	0.0625	22.0	48.0	1.59
A9011.6	–	1.60	0.0630	20.0	43.0	1.60
A9011.75	–	1.75	0.0689	22.0	46.0	1.75
A9011.8	–	1.80	0.0709	22.0	46.0	1.80
A9011.9	–	1.90	0.0748	22.0	46.0	1.90
A9015/64	5/64	1.98	0.0781	25.0	51.0	1.98
A9012.0	–	2.00	0.0787	24.0	49.0	2.00
A9012.1	–	2.10	0.0827	24.0	49.0	2.10
A9012.15	–	2.15	0.0846	27.0	53.0	2.15
A9013/32	3/32	2.38	0.0937	32.0	57.0	2.38
A9012.4	–	2.40	0.0945	30.0	57.0	2.40
A9012.5	–	2.50	0.0984	30.0	57.0	2.50
A9012.6	–	2.60	0.1024	30.0	57.0	2.60
A9012.7	–	2.70	0.1063	33.0	61.0	2.70
A9017/64	7/64	2.78	0.1094	38.0	67.0	2.78
A9012.9	–	2.90	0.1142	33.0	61.0	2.90
A9013.0	–	3.00	0.1181	33.0	61.0	3.00
A9013.1	–	3.10	0.1220	36.0	65.0	3.10
A9011/8	1/8	3.18	0.1250	41.0	70.0	3.18
A9013.2	–	3.20	0.1260	36.0	65.0	3.20
A9013.3	–	3.30	0.1299	36.0	65.0	3.30
A9013.4	–	3.40	0.1339	39.0	70.0	3.40
A9013.5	–	3.50	0.1378	39.0	70.0	3.50
A9013.6	–	3.60	0.1417	39.0	70.0	3.60

Produkt	DC (inch)	DC (mm)	DC (inch)	LCF (mm)	OAL (mm)	DCON MS (mm)
A9019/64	9/64	3.57	0.1406	44.0	73.0	3.57
A9013.7	–	3.70	0.1457	39.0	70.0	3.70
A9013.8	–	3.80	0.1496	43.0	75.0	3.80
A9013.9	–	3.90	0.1535	43.0	75.0	3.90
A9015/32	5/32	3.97	0.1563	51.0	79.0	3.97
A9014.0	–	4.00	0.1575	43.0	75.0	4.00
A9014.1	–	4.10	0.1614	43.0	75.0	4.10
A9014.2	–	4.20	0.1654	43.0	75.0	4.20
A9014.3	–	4.30	0.1693	47.0	80.0	4.30
A90111/64	11/64	4.37	0.1719	54.0	83.0	4.37
A9014.4	–	4.40	0.1732	47.0	80.0	4.40
A9014.5	–	4.50	0.1772	47.0	80.0	4.50
A9014.6	–	4.60	0.1811	47.0	80.0	4.60
A9014.7	–	4.70	0.1850	47.0	80.0	4.70
A9013/16	3/16	4.76	0.1875	59.0	89.0	4.76
A9014.8	–	4.80	0.1890	52.0	86.0	4.80
A9014.9	–	4.90	0.1929	52.0	86.0	4.90
A9015.0	–	5.00	0.1969	52.0	86.0	5.00
A9015.1	–	5.10	0.2008	52.0	86.0	5.10
A90113/64	13/64	5.16	0.2031	62.0	92.0	5.16
A9015.2	–	5.20	0.2047	52.0	86.0	5.20
A9015.3	–	5.30	0.2087	52.0	86.0	5.30
A9015.4	–	5.40	0.2126	57.0	93.0	5.40
A9015.5	–	5.50	0.2165	57.0	93.0	5.50
A9017/32	7/32	5.56	0.2188	64.0	95.0	5.56
A9015.6	–	5.60	0.2205	57.0	93.0	5.60



Produkt	DC	DC	DC	LCF	OAL	DCON MS
	(inch)	(mm)	(inch)	(mm)	(mm)	(mm)
A9015.7	–	5.70	0.2244	57.0	93.0	5.70
A9015.8	–	5.80	0.2283	57.0	93.0	5.80
A9015.9	–	5.90	0.2323	57.0	93.0	5.90
A90115/64	15/64	5.95	0.2344	67.0	98.0	5.95
A9016.0	–	6.00	0.2362	57.0	93.0	6.00
A9016.1	–	6.10	0.2402	63.0	101.0	6.10
A9016.2	–	6.20	0.2441	63.0	101.0	6.20
A9016.3	–	6.30	0.2480	63.0	101.0	6.30
A9011/4	1/4	6.35	0.2500	70.0	102.0	6.35
A9016.4	–	6.40	0.2520	63.0	101.0	6.40
A9016.5	–	6.50	0.2559	63.0	101.0	6.50
A9016.6	–	6.60	0.2598	63.0	101.0	6.60
A9016.7	–	6.70	0.2638	63.0	101.0	6.70
A90117/64	17/64	6.75	0.2656	73.0	105.0	6.75
A9016.8	–	6.80	0.2677	69.0	109.0	6.80
A9016.9	–	6.90	0.2717	69.0	109.0	6.90
A9017.0	–	7.00	0.2756	69.0	109.0	7.00
A9017.1	–	7.10	0.2795	69.0	109.0	7.10
A9019/32	9/32	7.14	0.2813	75.0	108.0	7.14
A9017.2	–	7.20	0.2835	69.0	109.0	7.20
A9017.3	–	7.30	0.2874	69.0	109.0	7.30
A9017.4	–	7.40	0.2913	69.0	109.0	7.40
A9017.5	–	7.50	0.2953	69.0	109.0	7.50
A90119/64	19/64	7.54	0.2969	78.0	111.0	7.54
A9017.6	–	7.60	0.2992	75.0	117.0	7.60
A9017.7	–	7.70	0.3031	75.0	117.0	7.70
A9017.8	–	7.80	0.3071	75.0	117.0	7.80
A9017.9	–	7.90	0.3110	75.0	117.0	7.90
A9015/16	5/16	7.94	0.3125	81.0	114.0	7.94
A9018.0	–	8.00	0.3150	75.0	117.0	8.00
A9018.1	–	8.10	0.3189	75.0	117.0	8.10
A9018.2	–	8.20	0.3228	75.0	117.0	8.20
A9018.3	–	8.30	0.3268	75.0	117.0	8.30
A90121/64	21/64	8.33	0.3281	84.0	117.0	8.33
A9018.4	–	8.40	0.3307	75.0	117.0	8.40
A9018.5	–	8.50	0.3346	75.0	117.0	8.50
A9018.6	–	8.60	0.3386	81.0	125.0	8.60
A9018.7	–	8.70	0.3425	81.0	125.0	8.70
A90111/32	11/32	8.73	0.3438	87.0	121.0	8.73
A9018.8	–	8.80	0.3465	81.0	125.0	8.80
A9018.9	–	8.90	0.3504	81.0	125.0	8.90
A9019.0	–	9.00	0.3543	81.0	125.0	9.00
A9019.1	–	9.10	0.3583	81.0	125.0	9.10

Produkt	DC	DC	DC	LCF	OAL	DCON MS
	(inch)	(mm)	(inch)	(mm)	(mm)	(mm)
A90123/64	23/64	9.13	0.3594	89.0	124.0	9.13
A9019.2	–	9.20	0.3622	81.0	125.0	9.20
A9019.3	–	9.30	0.3661	81.0	125.0	9.30
A9019.4	–	9.40	0.3701	81.0	125.0	9.40
A9019.5	–	9.50	0.3740	81.0	125.0	9.50
A9013/8	3/8	9.52	0.3750	92.0	127.0	9.52
A9019.6	–	9.60	0.3780	87.0	133.0	9.60
A9019.7	–	9.70	0.3819	87.0	133.0	9.70
A9019.8	–	9.80	0.3858	87.0	133.0	9.80
A9019.9	–	9.90	0.3898	87.0	133.0	9.90
A90125/64	25/64	9.92	0.3906	95.0	130.0	9.92
A90110.0	–	10.00	0.3937	87.0	133.0	10.00
A90110.2	–	10.20	0.4016	87.0	133.0	10.20
A90110.3	–	10.30	0.4055	87.0	133.0	10.30
A90113/32	13/32	10.32	0.4063	98.0	133.0	10.32
A90110.4	–	10.40	0.4094	87.0	133.0	10.40
A90110.5	–	10.50	0.4134	87.0	133.0	10.50
A90127/64	27/64	10.72	0.4219	100.0	137.0	10.72
A90110.8	–	10.80	0.4252	94.0	142.0	10.80
A90111.0	–	11.00	0.4331	94.0	142.0	11.00
A9017/16	7/16	11.11	0.4375	103.0	140.0	11.11
A90111.5	–	11.50	0.4528	94.0	142.0	11.50
A90129/64	29/64	11.51	0.4531	106.0	143.0	11.51
A90111.8	–	11.80	0.4646	94.0	142.0	11.80
A90115/32	15/32	11.91	0.4688	110.0	146.0	11.91
A90112.0	–	12.00	0.4724	101.0	151.0	12.00
A90131/64	31/64	12.30	0.4844	111.0	149.0	12.30
A90112.5	–	12.50	0.4921	101.0	151.0	12.50
A9011/2	1/2	12.70	0.5000	101.0	151.0	12.70
A90113.0	–	13.00	0.5118	101.0	151.0	13.00
A90133/64	33/64	13.10	0.5156	122.0	168.0	13.10
A90113.5	–	13.50	0.5315	108.0	160.0	13.50
A90135/64	35/64	13.89	0.5469	122.0	168.0	13.89
A90114.0	–	14.00	0.5512	108.0	160.0	14.00
A9019/16	9/16	14.29	0.5625	122.0	168.0	14.29
A90114.5	–	14.50	0.5709	114.0	169.0	14.50
A90137/64	37/64	14.68	0.5781	122.0	168.0	14.68
A90115.0	–	15.00	0.5906	114.0	169.0	15.00
A90119/32	19/32	15.08	0.5938	132.0	181.0	15.08
A90139/64	39/64	15.48	0.6094	132.0	181.0	15.48
A90115.5	–	15.50	0.6102	120.0	178.0	15.50
A9015/8	5/8	15.88	0.6250	132.0	181.0	15.88
A90116.0	–	16.00	0.6299	120.0	178.0	16.00



A170



HSS Vrták se zúženou stopkou a povrchovou úpravou, Parní temperace povrchu

Vrták konstruovaný se stopkou 1/2" i pro větší pracovní průměry vrtáků umožňuje upnutí i do konvenčních strojů s ručním upínáním. Vrcholový úhel vrtáku 118° usnadňuje přebrušování. Parní temperace povrchu zadržuje řeznou kapalinu a zabraňuje nalepování třísek. Vhodný pro širokou oblast obráběných materiálů.

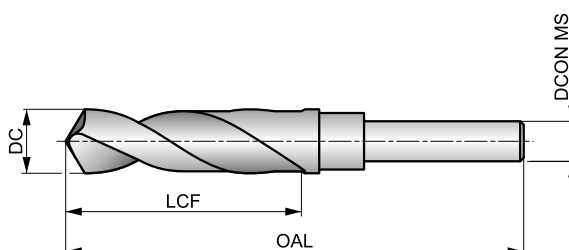

HSS	DORMER	4xD
118°	ST	
λ 20-35°	R	DC h8

Skupiny obráběných materiálů, startovní řezná rychlost (Vc m/min) a kód posuvu. Tabulku s posuvem na otáčku naleznete od strany 175.

P1.1 ■ 33 H	P1.2 ■ 37 H	P1.3 ■ 38 H	P2.1 ■ 28 H	P2.2 ■ 25 F	P2.3 ■ 22 D	P3.1 ■ 19 E	P3.2 ■ 15 E	P3.3 ■ 13 D	P4.1 ■ 11 E	P4.2 ■ 10 D	P4.3 ■ 8 C	M1.1 ■ 21 D	M1.2 ■ 17 D
M2.1 ■ 18 D	M2.2 ■ 15 D	M3.1 ■ 8 F	M3.2 ■ 7 F	M3.3 ■ 6 F	M4.1 ■ 7 B	K1.1 ■ 27 H	K1.2 ■ 20 E	K1.3 ■ 15 E	K2.1 ■ 23 D	K2.2 ■ 19 D	K2.3 ■ 15 D	K3.1 ■ 21 D	K3.2 ■ 16 D
K3.3 ■ 13 D	K4.1 ■ 19 D	K4.2 ■ 14 D	K4.3 ■ 11 D	K4.4 ■ 19 D	K4.5 ■ 8 D	K5.1 ■ 22 D	K5.2 ■ 16 D	K5.3 ■ 13 D	N1.1 ■ 33 I	N1.2 ■ 25 I	N1.3 ■ 17 H	N2.1 ■ 42 G	N2.2 ■ 37 G
N2.3 ■ 27 G	N3.1 ■ 56 G	N3.2 ■ 33 H	N3.3 ■ 17 F	N4.1 ■ 30 I	N4.2 ■ 28 G	N4.3 ■ 14 E	S1.1 ■ 17 E	S1.2 ■ 9 C	S1.3 ■ 5 A	S2.1 ■ 5 D	S2.2 ■ 4 A	S3.1 ■ 4 D	S3.2 ■ 3 A
S4.1 ■ 3 D	S4.2 ■ 2 A												

Produkt	DC	DC	DC	LCF	OAL	LCF	OAL	DCON MS
	(inch)	(mm)	(inch)	(inch)	(inch)	(mm)	(mm)	
A17013.0	–	13.00	0.5118	–	–	83.0	156.0	12,7
A17033/64	33/64	13.10	0.5156	3.1/8	6"	–	–	12,7
A17017/32	17/32	13.49	0.5313	3.1/8	6"	–	–	12,7
A17013.5	–	13.50	0.5315	–	–	83.0	156.0	12,7
A17035/64	35/64	13.89	0.5469	3.1/8	6"	–	–	12,7
A17014.0	–	14.00	0.5512	–	–	83.0	156.0	12,7
A1709/16	9/16	14.29	0.5625	3.1/8	6"	–	–	12,7
A17014.5	–	14.50	0.5709	–	–	83.0	156.0	12,7
A17037/64	37/64	14.68	0.5781	3.1/8	6"	–	–	12,7
A17015.0	–	15.00	0.5906	–	–	83.0	156.0	12,7
A17019/32	19/32	15.08	0.5938	3.1/8	6"	–	–	12,7
A17039/64	39/64	15.48	0.6094	3.1/8	6"	–	–	12,7
A17015.5	–	15.50	0.6102	–	–	83.0	156.0	12,7
A1705/8	5/8	15.88	0.6250	3.1/8	6"	–	–	12,7
A17016.0	–	16.00	0.6299	–	–	84.0	157.0	12,7
A17041/64	41/64	16.27	0.6406	3.1/8	6"	–	–	12,7
A17016.5	–	16.50	0.6496	–	–	84.0	157.0	12,7
A17021/32	21/32	16.67	0.6563	3.1/8	6"	–	–	12,7
A17017.0	–	17.00	0.6693	–	–	84.0	157.0	12,7
A17043/64	43/64	17.07	0.6719	3.1/8	6"	–	–	12,7
A17011/16	11/16	17.46	0.6875	3.1/8	6"	–	–	12,7
A17017.5	–	17.50	0.6890	–	–	84.0	157.0	12,7
A17045/64	45/64	17.86	0.7031	3.1/8	6"	–	–	12,7
A17018.0	–	18.00	0.7087	–	–	84.0	157.0	12,7



Produkt	DC	DC	DC	LCF	OAL	LCF	OAL	DCON MS
	(inch)	(mm)	(inch)	(inch)	(inch)	(mm)	(mm)	(mm)
A17023/32	23/32	18.26	0.7188	3.1/8	6"	–	–	12,7
A17018.5	–	18.50	0.7283	–	–	84.0	157.0	12,7
A17047/64	47/64	18.65	0.7344	3.1/8	6"	–	–	12,7
A17019.0	–	19.00	0.7480	–	–	84.0	157.0	12,7
A1703/4	3/4	19.05	0.7500	3.1/8	6"	–	–	12,7
A17049/64	49/64	19.45	0.7656	3"	6"	–	–	12,7
A17019.5	–	19.50	0.7677	–	–	81.0	158.0	12,7
A17025/32	25/32	19.84	0.7813	3"	6"	–	–	12,7
A17020.0	–	20.00	0.7874	–	–	81.0	158.0	12,7
A17051/64	51/64	20.24	0.7969	3"	6"	–	–	12,7
A17013/16	13/16	20.64	0.8125	3"	6"	–	–	12,7
A17021.0	–	21.00	0.8268	–	–	82.0	158.0	12,7
A17053/64	53/64	21.03	0.8281	3"	6"	–	–	12,7
A17027/32	27/32	21.43	0.8437	3"	6"	–	–	12,7
A17055/64	55/64	21.83	0.8594	3"	6"	–	–	12,7
A17022.0	–	22.00	0.8661	–	–	82.0	158.0	12,7
A1707/8	7/8	22.22	0.8750	3"	6"	–	–	12,7
A17057/64	57/64	22.62	0.8906	3"	6"	–	–	12,7
A17023.0	–	23.00	0.9055	–	–	82.0	158.0	12,7
A17029/32	29/32	23.02	0.9063	3"	6"	–	–	12,7
A17059/64	59/64	23.42	0.9219	3"	6"	–	–	12,7
A17015/16	15/16	23.81	0.9375	3"	6"	–	–	12,7
A17024.0	–	24.00	0.9449	–	–	83.0	159.0	12,7
A17061/64	61/64	24.21	0.9531	3"	6"	–	–	12,7
A17031/32	31/32	24.61	0.9688	3"	6"	–	–	12,7
A17025.0	–	25.00	0.9843	–	–	83.0	159.0	12,7
A17063/64	63/64	25.00	0.9844	3"	6"	–	–	12,7
A1701	1"	25.40	1.0000	3"	6"	–	–	12,7
A1701.1/32	1.1/32	26.19	1.0313	3"	6"	–	–	12,7
A1701.1/16	1.1/16	26.99	1.0625	3"	6"	–	–	12,7
A1701.7/64	1.7/64	28.18	1.1094	3"	6"	–	–	12,7
A1701.1/8	1.1/8	28.58	1.1250	3"	6"	–	–	12,7
A1701.9/64	1.9/64	28.97	1.1406	3"	6"	–	–	12,7
A1701.5/32	1.5/32	29.37	1.1563	3"	6"	–	–	12,7
A1701.3/16	1.3/16	30.16	1.1875	3"	6"	–	–	12,7
A1701.7/32	1.7/32	30.96	1.2188	3"	6"	–	–	12,7
A1701.1/4	1.1/4	31.75	1.2500	3"	6"	–	–	12,7
A1701.5/16	1.5/16	33.34	1.3125	3"	6"	–	–	12,7
A1701.3/8	1.3/8	34.93	1.3750	3"	6"	–	–	12,7
A1701.7/16	1.7/16	36.51	1.4375	3"	6"	–	–	12,7
A1701.1/2	1.1/2	38.10	1.5000	3"	6"	–	–	12,7



A243



HSS Prodloužený vrták pro letecký průmysl, Leštěný

Vrták dle normy NAS907 s vrcholovým úhlem 135° napomáhá středění. Velká celková délka spolu s malou pracovní délkou usnadňují vrtání v těžko dostupných místech. Vhodný pro širokou oblast obráběných materiálů.

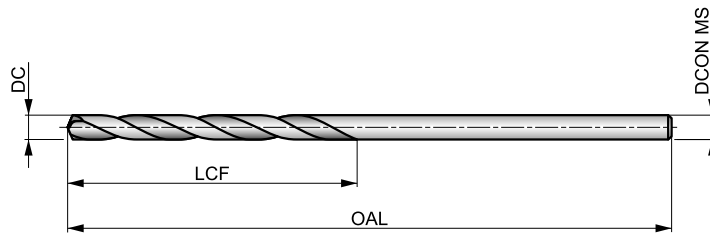

HSS	NAS 907	4xD
135°	Bright	
λ 20-35°	R	DC h8

Skupiny obráběných materiálů, startovní řezná rychlost (Vc m/min) a kód posuvu. Tabulku s posuvem na otáčku naleznete od strany 175.

P2.2 ▣ 25 F	P2.3 ▣ 22 E	P3.1 ▣ 19 F	P3.2 ▣ 15 F	P3.3 ▣ 13 E	P4.1 ▣ 11 F	P4.2 ▣ 10 E	P4.3 ▣ 8 D	M1.1 ▣ 21 E	M1.2 ▣ 17 E	M2.1 ▣ 18 E	M2.2 ▣ 15 E	M3.1 ▣ 9 G	M3.2 ▣ 8 G
M3.3 ▣ 7 G	M4.1 ▣ 9 C	K1.1 ▣ 30 I	K1.2 ▣ 22 F	K1.3 ▣ 17 F	K2.1 ▣ 25 E	K2.2 ▣ 20 E	K2.3 ▣ 16 E	K3.1 ▣ 22 E	K3.2 ▣ 17 E	K3.3 ▣ 13 E	K4.1 ▣ 20 E	K4.2 ▣ 15 E	K4.3 ▣ 11 E
K4.4 ▣ 10 E	K4.5 ▣ 8 E	K5.1 ▣ 23 E	K5.2 ▣ 17 E	K5.3 ▣ 13 E	N3.1 ▣ 27 H	S1.1 ▣ 23 F	S1.2 ▣ 12 D	S1.3 ▣ 6 B	S2.1 ▣ 8 E	S2.2 ▣ 4 A	S3.1 ▣ 6 E	S3.2 ▣ 3 A	S4.1 ▣ 5 E
S4.2 ▣ 2 A													

150 mm celková délka (OAL).

Produkt	DC (inch)	DC (inch)	LCF (inch)	OAL (inch)	DCON MS (inch)
A2433/32X6	3/32	0.0938	1.1/4	6"	0.0938
A243N40X6	N40	0.0980	1.3/8	6"	0.0980
A2431/8X6	1/8	0.1250	1.5/8	6"	0.1250
A243N30X6	N30	0.1285	1.5/8	6"	0.1285
A2435/32X6	5/32	0.1563	2"	6"	0.1563
A243N21X6	N21	0.1590	2.1/8	6"	0.1590

Produkt	DC (inch)	DC (inch)	LCF (inch)	OAL (inch)	DCON MS (inch)
A243N20X6	N20	0.1610	2.1/8	6"	0.1610
A2433/16X6	3/16	0.1875	2.5/16	6"	0.1875
A243N11X6	N11	0.1910	2.5/16	6"	0.1910
A243N10X6	N10	0.1935	2.7/16	6"	0.1935
A2431/4X6	1/4	0.2500	2.3/4	6"	0.2500



A244



HSS Prodloužený vrták pro letecký průmysl, Leštěný

Vrták dle normy NAS907 s vrcholovým úhlem 118° napomáhá středění. Velká celková délka spolu s malou pracovní délkou usnadňují vrtání v těžko dostupných místech. Vhodný pro širokou oblast obráběných materiálů.

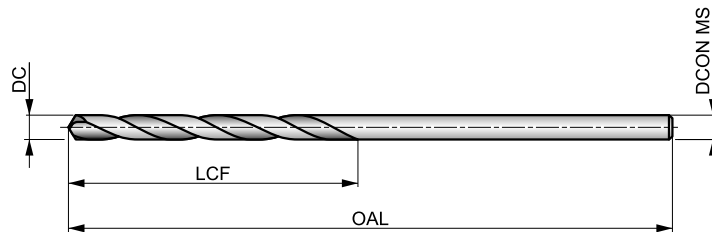

HSS	NAS 907	4xD
118°	Bright	
λ 20-35°	R	DC h8

Skupiny obráběných materiálů, startovní řezná rychlost (Vc m/min) a kód posuvu. Tabulku s posuvem na otáčku naleznete od strany 175.

P2.2 ▣ 25 F	P2.3 ▣ 22 E	P3.1 ▣ 19 F	P3.2 ▣ 15 F	P3.3 ▣ 13 E	P4.1 ▣ 11 F	P4.2 ▣ 10 E	P4.3 ▣ 8 D	M1.1 ▣ 21 E	M1.2 ▣ 17 E	M2.1 ▣ 18 E	M2.2 ▣ 15 E	M3.1 ▣ 9 G	M3.2 ▣ 8 G
M3.3 ▣ 7 G	M4.1 ▣ 9 C	K1.1 ▣ 30 I	K1.2 ▣ 22 F	K1.3 ▣ 17 F	K2.1 ▣ 25 E	K2.2 ▣ 20 E	K2.3 ▣ 16 E	K3.1 ▣ 22 E	K3.2 ▣ 17 E	K3.3 ▣ 13 E	K4.1 ▣ 20 E	K4.2 ▣ 15 E	K4.3 ▣ 11 E
K4.4 ▣ 10 E	K4.5 ▣ 8 E	K5.1 ▣ 23 E	K5.2 ▣ 17 E	K5.3 ▣ 13 E	N3.1 ▣ 27 H	S1.1 ▣ 23 F	S1.2 ▣ 12 D	S1.3 ▣ 6 B	S2.1 ▣ 8 E	S2.2 ▣ 4 A	S3.1 ▣ 6 E	S3.2 ▣ 3 A	S4.1 ▣ 5 E
S4.2 ▣ 2 A													

150 mm celková délka (OAL).

Produkt	DC (inch)	DC (inch)	LCF (inch)	OAL (inch)	DCON MS (inch)
A2441/8X6	1/8	0.1250	1.5/8	6"	0.1250
A2445/32X6	5/32	0.1563	2"	6"	0.1563
A2443/16X6	3/16	0.1875	2.5/16	6"	0.1875
A2441/4X6	1/4	0.2500	2.3/4	6"	0.2500



A110



HSS Vrták, Dlouhé provedení, Parní temperace povrchu

Pro vrtání hlubších otvorů. Vrcholový úhel vrtáku 118° pro snadné a ekonomické přebušování. Parní temperace povrchu zadržuje řeznou kapalinu a brání nalepování třísek. Vhodný pro ruční i strojní operace.

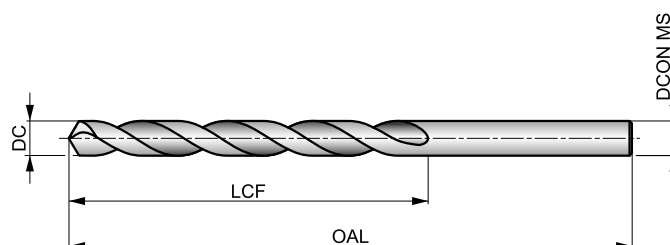

HSS	DIN 340	6xD
118°	ST	
λ 20-35°	R	DC h8

Skupiny obráběných materiálů, startovní řezná rychlost (Vc m/min) a kód posuvu. Tabulku s posuvem na otáčku naleznete od strany 175.

P1.1 ■ 27 G	P1.2 ■ 30 G	P1.3 ■ 31 G	P2.1 ■ 23 G	P2.2 ■ 20 E	P2.3 ■ 18 D	P3.1 ■ 13 E	P3.2 ■ 11 E	P3.3 ■ 9 D	P4.1 ■ 8 E	P4.2 ■ 7 D	P4.3 ■ 5 B	M1.1 ■ 14 D	M1.2 ■ 12 D
M2.1 ■ 12 D	M2.2 ■ 10 D	M3.1 ■ 7 F	M3.2 ■ 6 F	M3.3 ■ 5 F	M4.1 ■ 4 B	K1.1 ■ 28 H	K1.2 ■ 21 E	K1.3 ■ 16 E	K2.1 ■ 18 D	K2.2 ■ 15 D	K2.3 ■ 12 D	K3.1 ■ 16 D	K3.2 ■ 12 D
K3.3 ■ 10 D	K4.1 ■ 15 D	K4.2 ■ 11 D	K4.3 ■ 8 D	K4.4 ■ 7 D	K4.5 ■ 6 D	K5.1 ■ 17 D	K5.2 ■ 13 D	K5.3 ■ 10 D	N1.1 ■ 32 I	N1.2 ■ 24 I	N1.3 ■ 16 H	N2.1 ■ 42 G	N2.2 ■ 37 G
N2.3 ■ 27 G	N3.1 ■ 54 G	N3.2 ■ 32 H	N3.3 ■ 16 E	N4.1 ■ 35 I	N4.2 ■ 26 G	N4.3 ■ 12 E	S1.1 ■ 17 E	S1.2 ■ 9 C	S1.3 ■ 4 A	S2.1 ■ 5 D	S2.2 ■ 4 A	S3.1 ■ 4 D	S3.2 ■ 3 A
S4.1 ■ 3 D	S4.2 ■ 2 A												

DC <= 1mm (1/16") - leštěný.

Produkt	DC (inch)	DC (mm)	DC (inch)	LCF (mm)	OAL (mm)	DCON MS (mm)
A110.5	-	0.50	0.0197	12.0	32.0	0.50
A110.6	-	0.60	0.0236	15.0	35.0	0.60
A110.7	-	0.70	0.0276	21.0	42.0	0.70
A1101/32	1/32	0.79	0.0313	25.0	46.0	0.79
A110.8	-	0.80	0.0315	25.0	46.0	0.80
A110.9	-	0.90	0.0354	29.0	51.0	0.90
A1101.0	-	1.00	0.0394	33.0	56.0	1.00
A1101.1	-	1.10	0.0433	37.0	60.0	1.10
A1101.2	-	1.20	0.0472	41.0	65.0	1.20
A1101.3	-	1.30	0.0512	41.0	65.0	1.30
A1101.4	-	1.40	0.0551	45.0	70.0	1.40
A1101.5	-	1.50	0.0591	45.0	70.0	1.50
A1101/16	1/16	1.59	0.0625	50.0	76.0	1.59
A1101.6	-	1.60	0.0630	50.0	76.0	1.60
A1101.7	-	1.70	0.0669	50.0	76.0	1.70
A1101.75	-	1.75	0.0689	53.0	80.0	1.75
A1101.8	-	1.80	0.0709	53.0	80.0	1.80
A1101.9	-	1.90	0.0748	53.0	80.0	1.90
A1105/64	5/64	1.98	0.0781	56.0	85.0	1.98
A1102.0	-	2.00	0.0787	56.0	85.0	2.00
A1102.05	-	2.05	0.0807	56.0	85.0	2.05
A1102.1	-	2.10	0.0827	56.0	85.0	2.10
A1102.2	-	2.20	0.0866	59.0	90.0	2.20
A1102.25	-	2.25	0.0886	59.0	90.0	2.25

Produkt	DC (inch)	DC (mm)	DC (inch)	LCF (mm)	OAL (mm)	DCON MS (mm)
A1102.3	-	2.30	0.0906	59.0	90.0	2.30
A1103/32	3/32	2.38	0.0938	62.0	95.0	2.38
A1102.4	-	2.40	0.0945	62.0	95.0	2.40
A1102.5	-	2.50	0.0984	62.0	95.0	2.50
A1102.6	-	2.60	0.1024	62.0	95.0	2.60
A1102.7	-	2.70	0.1063	66.0	100.0	2.70
A1107/64	7/64	2.78	0.1094	66.0	100.0	2.78
A1102.8	-	2.80	0.1102	66.0	100.0	2.80
A1102.9	-	2.90	0.1142	66.0	100.0	2.90
A1103.0	-	3.00	0.1181	66.0	100.0	3.00
A1103.1	-	3.10	0.1220	69.0	106.0	3.10
A1101/8	1/8	3.18	0.1250	69.0	106.0	3.18
A1103.2	-	3.20	0.1260	69.0	106.0	3.20
A1103.25	-	3.25	0.1280	69.0	106.0	3.25
A1103.3	-	3.30	0.1299	69.0	106.0	3.30
A1103.4	-	3.40	0.1339	73.0	112.0	3.40
A1103.5	-	3.50	0.1378	73.0	112.0	3.50
A1109/64	9/64	3.57	0.1406	73.0	112.0	3.57
A1103.6	-	3.60	0.1417	73.0	112.0	3.60
A1103.7	-	3.70	0.1457	73.0	112.0	3.70
A1103.75	-	3.75	0.1476	73.0	112.0	3.75
A1103.8	-	3.80	0.1496	78.0	119.0	3.80
A1103.9	-	3.90	0.1535	78.0	119.0	3.90
A1105/32	5/32	3.97	0.1563	78.0	119.0	3.97



Produkt	DC	DC	DC	LCF	OAL	D CON MS
	(inch)	(mm)	(inch)	(mm)	(mm)	(mm)
A1104.0	–	4.00	0.1575	78.0	119.0	4.00
A1104.1	–	4.10	0.1614	78.0	119.0	4.10
A1104.2	–	4.20	0.1654	78.0	119.0	4.20
A1104.25	–	4.25	0.1673	78.0	119.0	4.25
A1104.3	–	4.30	0.1693	82.0	126.0	4.30
A11011/64	11/64	4.37	0.1719	82.0	126.0	4.37
A1104.4	–	4.40	0.1732	82.0	126.0	4.40
A1104.5	–	4.50	0.1772	82.0	126.0	4.50
A1104.6	–	4.60	0.1811	82.0	126.0	4.60
A1104.7	–	4.70	0.1850	82.0	126.0	4.70
A1104.75	–	4.75	0.1870	82.0	126.0	4.75
A1103/16	3/16	4.76	0.1875	87.0	132.0	4.76
A1104.8	–	4.80	0.1890	87.0	132.0	4.80
A1104.9	–	4.90	0.1929	87.0	132.0	4.90
A1105.0	–	5.00	0.1969	87.0	132.0	5.00
A1105.1	–	5.10	0.2008	87.0	132.0	5.10
A11013/64	13/64	5.16	0.2031	87.0	132.0	5.16
A1105.2	–	5.20	0.2047	87.0	132.0	5.20
A1105.25	–	5.25	0.2067	87.0	132.0	5.25
A1105.3	–	5.30	0.2087	87.0	132.0	5.30
A1105.4	–	5.40	0.2126	91.0	139.0	5.40
A1105.5	–	5.50	0.2165	91.0	139.0	5.50
A1107/32	7/32	5.56	0.2188	91.0	139.0	5.56
A1105.6	–	5.60	0.2205	91.0	139.0	5.60
A1105.7	–	5.70	0.2244	91.0	139.0	5.70
A1105.75	–	5.75	0.2264	91.0	139.0	5.75
A1105.8	–	5.80	0.2283	91.0	139.0	5.80
A1105.9	–	5.90	0.2323	91.0	139.0	5.90
A11015/64	15/64	5.95	0.2344	91.0	139.0	5.95
A1106.0	–	6.00	0.2362	91.0	139.0	6.00
A1106.1	–	6.10	0.2402	97.0	148.0	6.10
A1106.2	–	6.20	0.2441	97.0	148.0	6.20
A1106.25	–	6.25	0.2461	97.0	148.0	6.25
A1106.3	–	6.30	0.2480	97.0	148.0	6.30
A1101/4	1/4	6.35	0.2500	97.0	148.0	6.35
A1106.4	–	6.40	0.2520	97.0	148.0	6.40
A1106.5	–	6.50	0.2559	97.0	148.0	6.50
A1106.6	–	6.60	0.2598	97.0	148.0	6.60
A1106.7	–	6.70	0.2638	97.0	148.0	6.70
A11017/64	17/64	6.75	0.2656	102.0	156.0	6.75
A1106.75	–	6.75	0.2657	102.0	156.0	6.75
A1106.8	–	6.80	0.2677	102.0	156.0	6.80
A1106.9	–	6.90	0.2717	102.0	156.0	6.90
A1107.0	–	7.00	0.2756	102.0	156.0	7.00
A1107.1	–	7.10	0.2795	102.0	156.0	7.10
A1109/32	9/32	7.14	0.2813	102.0	156.0	7.14
A1107.2	–	7.20	0.2835	102.0	156.0	7.20
A1107.25	–	7.25	0.2854	102.0	156.0	7.25
A1107.3	–	7.30	0.2874	102.0	156.0	7.30
A1107.4	–	7.40	0.2913	102.0	156.0	7.40
A1107.5	–	7.50	0.2953	102.0	156.0	7.50
A1107.6	–	7.60	0.2992	109.0	165.0	7.60
A1107.7	–	7.70	0.3031	109.0	165.0	7.70
A1107.75	–	7.75	0.3051	109.0	165.0	7.75
A1107.8	–	7.80	0.3071	109.0	165.0	7.80
A1107.9	–	7.90	0.3110	109.0	165.0	7.90
A1105/16	5/16	7.94	0.3125	109.0	165.0	7.94
A1108.0	–	8.00	0.3150	109.0	165.0	8.00
A1108.1	–	8.10	0.3189	109.0	165.0	8.10
A1108.2	–	8.20	0.3228	109.0	165.0	8.20
A1108.25	–	8.25	0.3248	109.0	165.0	8.25
A1108.3	–	8.30	0.3268	109.0	165.0	8.30
A1108.4	–	8.40	0.3307	109.0	165.0	8.40
A1108.5	–	8.50	0.3346	109.0	165.0	8.50
A1108.6	–	8.60	0.3386	115.0	175.0	8.60

Produkt	DC	DC	DC	LCF	OAL	D CON MS
	(inch)	(mm)	(inch)	(mm)	(mm)	(mm)
A1108.7	–	8.70	0.3425	115.0	175.0	8.70
A11011/32	11/32	8.73	0.3438	115.0	175.0	8.73
A1108.75	–	8.75	0.3445	115.0	175.0	8.75
A1108.8	–	8.80	0.3465	115.0	175.0	8.80
A1108.9	–	8.90	0.3504	115.0	175.0	8.90
A1109.0	–	9.00	0.3543	115.0	175.0	9.00
A1109.1	–	9.10	0.3583	115.0	175.0	9.10
A1109.2	–	9.20	0.3622	115.0	175.0	9.20
A1109.25	–	9.25	0.3642	115.0	175.0	9.25
A1109.3	–	9.30	0.3661	115.0	175.0	9.30
A1109.4	–	9.40	0.3701	115.0	175.0	9.40
A1109.5	–	9.50	0.3740	115.0	175.0	9.50
A1103/8	3/8	9.52	0.3750	121.0	184.0	9.52
A1109.6	–	9.60	0.3780	121.0	184.0	9.60
A1109.7	–	9.70	0.3819	121.0	184.0	9.70
A1109.75	–	9.75	0.3839	121.0	184.0	9.75
A1109.8	–	9.80	0.3858	121.0	184.0	9.80
A1109.9	–	9.90	0.3898	121.0	184.0	9.90
A11010.0	–	10.00	0.3937	121.0	184.0	10.00
A11010.1	–	10.10	0.3976	121.0	184.0	10.10
A11010.2	–	10.20	0.4016	121.0	184.0	10.20
A11010.25	–	10.25	0.4035	121.0	184.0	10.25
A11010.3	–	10.30	0.4055	121.0	184.0	10.30
A11013/32	13/32	10.32	0.4063	121.0	184.0	10.32
A11010.5	–	10.50	0.4134	121.0	184.0	10.50
A11010.75	–	10.75	0.4232	128.0	195.0	10.75
A11010.8	–	10.80	0.4252	128.0	195.0	10.80
A11011.0	–	11.00	0.4331	128.0	195.0	11.00
A1107/16	7/16	11.11	0.4375	128.0	195.0	11.11
A11011.25	–	11.25	0.4429	128.0	195.0	11.25
A11011.4	–	11.40	0.4488	128.0	195.0	11.40
A11011.5	–	11.50	0.4528	128.0	195.0	11.50
A11011.75	–	11.75	0.4626	128.0	195.0	11.75
A11012.0	–	12.00	0.4724	134.0	205.0	12.00
A11012.1	–	12.10	0.4764	134.0	205.0	12.10
A11012.25	–	12.25	0.4823	134.0	205.0	12.25
A11012.5	–	12.50	0.4921	134.0	205.0	12.50
A1101/2	1/2	12.70	0.5000	134.0	205.0	12.70
A11013.0	–	13.00	0.5118	134.0	205.0	13.00
A11017/32	17/32	13.49	0.5313	140.0	214.0	13.49
A11013.5	–	13.50	0.5315	140.0	214.0	13.50
A11014.0	–	14.00	0.5512	140.0	214.0	14.00
A1109/16	9/16	14.29	0.5625	144.0	220.0	14.29
A11014.5	–	14.50	0.5709	144.0	220.0	14.50
A11015.0	–	15.00	0.5906	144.0	220.0	15.00
A11015.5	–	15.50	0.6102	149.0	227.0	15.50
A1105/8	5/8	15.88	0.6250	149.0	227.0	15.88
A11016.0	–	16.00	0.6299	149.0	227.0	16.00
A11016.5	–	16.50	0.6496	154.0	235.0	16.50
A11017.0	–	17.00	0.6693	154.0	235.0	17.00
A11011/16	11/16	17.46	0.6875	158.0	241.0	17.46
A11017.5	–	17.50	0.6890	158.0	241.0	17.50
A11018.0	–	18.00	0.7087	158.0	241.0	18.00
A11018.5	–	18.50	0.7283	162.0	247.0	18.50
A11019.0	–	19.00	0.7480	162.0	247.0	19.00
A1103/4	3/4	19.05	0.7500	166.0	254.0	19.05
A11019.5	–	19.50	0.7677	166.0	254.0	19.50
A11020.0	–	20.00	0.7874	166.0	254.0	20.00
A11021.0	–	21.00	0.8268	171.0	261.0	21.00
A11022.0	–	22.00	0.8661	176.0	268.0	22.00
A1107/8	7/8	22.22	0.8750	176.0	268.0	22.22
A11015/16	15/16	23.81	0.9375	185.0	282.0	23.81
A1101	1"	25.40	1.0000	190.0	290.0	25.40



A940



PFX HSS-E (5 % kobaltu) Vrták dlouhý, Leštěný

Produktivní vrták pro kvalitní a přesné otvory, vhodný pro vysoké řezné rychlosti a velké posuvy (tolerance otvorů H10). Vrcholový úhel 130° a speciální parabolická drážka usnadňuje vrtání hlubokých otvorů v jednom kroku. Vhodný pro širokou oblast obráběných materiálů.

PFX

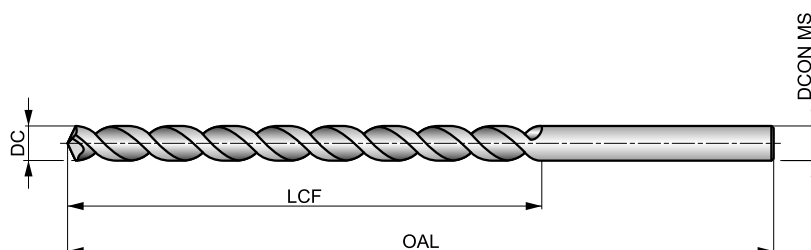

HSS-E	DIN ANSI	10xD
130°	Bright	
λ > 35°	R	DC h8

Skupiny obráběných materiálů, startovní řezná rychlost (Vc m/min) a kód posuvu. Tabulku s posuvem na otáčku naleznete od strany 175.

P1.1 ■ 29 F	P1.2 ■ 33 F	P1.3 ■ 34 F	P2.1 ■ 25 F	P2.2 ■ 22 G	P2.3 ■ 19 C	P3.1 ■ 25 G	P3.2 ■ 20 G	P3.3 ■ 17 C	P4.1 ■ 15 G	P4.2 ■ 13 C	P4.3 ■ 10 C	M1.1 ■ 21 C	M1.2 ■ 17 C
M2.1 ■ 18 C	M2.2 ■ 15 C	M3.1 ■ 8 E	M3.2 ■ 7 E	M3.3 ■ 6 E	M4.1 ■ 9 B	K2.1 ■ 20 I	K2.2 ■ 16 I	K2.3 ■ 13 H	K3.1 ■ 17 I	K3.2 ■ 13 I	K3.3 ■ 11 H	K4.1 ■ 16 I	K4.2 ■ 12 I
K4.3 ■ 9 H	K4.4 ■ 8 H	K4.5 ■ 6 H	K5.1 ■ 18 I	K5.2 ■ 14 I	K5.3 ■ 11 H	N1.1 ■ 53 H	N1.2 ■ 40 H	N1.3 ■ 27 N	N2.1 ■ 62 N	N2.2 ■ 55 N	N2.3 ■ 40 N	N3.1 ■ 119 G	N3.2 ■ 70 F
N3.3 ■ 35 F	N4.1 ■ 55 H	N4.2 ■ 40 F	S1.1 ■ 18 E	S1.2 ■ 13 C	S1.3 ■ 6 C								

DC >= 9.6mm - kratší než 10xD.

Produkt	DC	DC	DC	LCF	OAL	DCON MS
	(inch)	(mm)	(inch)	(mm)	(mm)	(mm)
A9401.0	-	1.00	0.0394	33.0	56.0	1.00
A9401.1	-	1.10	0.0433	37.0	60.0	1.10
A9403/64	3/64	1.19	0.0469	29.0	57.0	1.19
A9401.2	-	1.20	0.0472	41.0	65.0	1.20
A9401.3	-	1.30	0.0512	41.0	65.0	1.30
A9401.4	-	1.40	0.0551	45.0	70.0	1.40
A9401.5	-	1.50	0.0591	45.0	70.0	1.50
A9401/16	1/16	1.59	0.0625	44.0	76.0	1.59
A9401.6	-	1.60	0.0630	50.0	76.0	1.60
A9401.7	-	1.70	0.0669	50.0	76.0	1.70
A9401.8	-	1.80	0.0709	53.0	80.0	1.80
A9401.9	-	1.90	0.0748	53.0	80.0	1.90
A9405/64	5/64	1.98	0.0781	51.0	95.0	1.98
A9402.0	-	2.00	0.0787	56.0	85.0	2.00
A9402.1	-	2.10	0.0827	56.0	85.0	2.10
A9402.2	-	2.20	0.0866	59.0	90.0	2.20
A9402.3	-	2.30	0.0906	59.0	90.0	2.30
A9403/32	3/32	2.38	0.0938	57.0	108.0	2.38
A9402.4	-	2.40	0.0945	62.0	95.0	2.40
A9402.5	-	2.50	0.0984	62.0	95.0	2.50
A9402.6	-	2.60	0.1024	62.0	95.0	2.60
A9402.7	-	2.70	0.1063	66.0	100.0	2.70
A9407/64	7/64	2.78	0.1094	64.0	117.0	2.78
A9402.8	-	2.80	0.1102	66.0	100.0	2.80
A9402.9	-	2.90	0.1142	66.0	100.0	2.90

Produkt	DC	DC	DC	LCF	OAL	DCON MS
	(inch)	(mm)	(inch)	(mm)	(mm)	(mm)
A9403.0	-	3.00	0.1181	66.0	100.0	3.00
A9403.1	-	3.10	0.1220	69.0	106.0	3.10
A9401/8	1/8	3.18	0.1250	70.0	130.0	3.18
A9403.2	-	3.20	0.1260	69.0	106.0	3.20
A9403.3	-	3.30	0.1299	69.0	106.0	3.30
A9403.4	-	3.40	0.1339	73.0	112.0	3.40
A9403.5	-	3.50	0.1378	73.0	112.0	3.50
A9409/64	9/64	3.57	0.1406	76.0	137.0	3.57
A9403.6	-	3.60	0.1417	73.0	112.0	3.60
A9403.7	-	3.70	0.1457	73.0	112.0	3.70
A9403.8	-	3.80	0.1496	78.0	119.0	3.80
A9403.9	-	3.90	0.1535	78.0	119.0	3.90
A9405/32	5/32	3.97	0.1563	76.0	137.0	3.97
A9404.0	-	4.00	0.1575	78.0	119.0	4.00
A9404.1	-	4.10	0.1614	78.0	119.0	4.10
A9404.2	-	4.20	0.1654	78.0	119.0	4.20
A9404.3	-	4.30	0.1693	82.0	126.0	4.30
A94011/64	11/64	4.37	0.1719	86.0	146.0	4.37
A9404.4	-	4.40	0.1732	82.0	126.0	4.40
A9404.5	-	4.50	0.1772	82.0	126.0	4.50
A9404.6	-	4.60	0.1811	82.0	126.0	4.60
A9404.7	-	4.70	0.1850	82.0	126.0	4.70
A9403/16	3/16	4.76	0.1875	86.0	146.0	4.76
A9404.8	-	4.80	0.1890	87.0	132.0	4.80
A9404.9	-	4.90	0.1929	87.0	132.0	4.90



Produkt	DC	DC	DC	LCF	OAL	D CON MS
	(inch)	(mm)	(inch)	(mm)	(mm)	(mm)
A9405.0	–	5.00	0.1969	87.0	132.0	5.00
A9405.1	–	5.10	0.2008	87.0	132.0	5.10
A94013/64	13/64	5.16	0.2031	92.0	152.0	5.16
A9405.2	–	5.20	0.2047	87.0	132.0	5.20
A9405.3	–	5.30	0.2087	87.0	132.0	5.30
A9405.4	–	5.40	0.2126	91.0	139.0	5.40
A9405.5	–	5.50	0.2165	91.0	139.0	5.50
A9407/32	7/32	5.56	0.2188	92.0	152.0	5.56
A9405.6	–	5.60	0.2205	91.0	139.0	5.60
A9405.7	–	5.70	0.2244	91.0	139.0	5.70
A9405.8	–	5.80	0.2283	91.0	139.0	5.80
A9405.9	–	5.90	0.2323	91.0	139.0	5.90
A94015/64	15/64	5.95	0.2344	95.0	156.0	5.95
A9406.0	–	6.00	0.2362	91.0	139.0	6.00
A9406.1	–	6.10	0.2402	97.0	148.0	6.10
A9406.2	–	6.20	0.2441	97.0	148.0	6.20
A9406.3	–	6.30	0.2480	97.0	148.0	6.30
A9401/4	1/4	6.35	0.2500	95.0	156.0	6.35
A9406.4	–	6.40	0.2520	97.0	148.0	6.40
A9406.5	–	6.50	0.2559	97.0	148.0	6.50
A9406.6	–	6.60	0.2598	97.0	148.0	6.60
A9406.7	–	6.70	0.2638	97.0	148.0	6.70
A94017/64	17/64	6.75	0.2656	98.0	159.0	6.75
A9406.8	–	6.80	0.2677	102.0	156.0	6.80
A9406.9	–	6.90	0.2717	102.0	156.0	6.90
A9407.0	–	7.00	0.2756	102.0	156.0	7.00
A9407.1	–	7.10	0.2795	102.0	156.0	7.10
A9409/32	9/32	7.14	0.2813	98.0	159.0	7.14
A9407.2	–	7.20	0.2835	102.0	156.0	7.20
A9407.3	–	7.30	0.2874	102.0	156.0	7.30
A9407.4	–	7.40	0.2913	102.0	156.0	7.40
A9407.5	–	7.50	0.2953	102.0	156.0	7.50
A94019/64	19/64	7.54	0.2969	102.0	162.0	7.54
A9407.6	–	7.60	0.2992	109.0	165.0	7.60
A9407.7	–	7.70	0.3031	109.0	165.0	7.70
A9407.8	–	7.80	0.3071	109.0	165.0	7.80
A9407.9	–	7.90	0.3110	109.0	165.0	7.90
A9405/16	5/16	7.94	0.3125	102.0	162.0	7.94
A9408.0	–	8.00	0.3150	109.0	165.0	8.00
A9408.1	–	8.10	0.3189	109.0	165.0	8.10
A9408.2	–	8.20	0.3228	109.0	165.0	8.20
A9408.3	–	8.30	0.3268	109.0	165.0	8.30
A94021/64	21/64	8.33	0.3281	105.0	165.0	8.33
A9408.4	–	8.40	0.3307	109.0	165.0	8.40
A9408.5	–	8.50	0.3346	109.0	165.0	8.50
A9408.6	–	8.60	0.3386	115.0	175.0	8.60
A9408.7	–	8.70	0.3425	115.0	175.0	8.70
A94011/32	11/32	8.73	0.3438	105.0	165.0	8.73
A9408.8	–	8.80	0.3465	115.0	175.0	8.80
A9408.9	–	8.90	0.3504	115.0	175.0	8.90
A9409.0	–	9.00	0.3543	115.0	175.0	9.00
A9409.1	–	9.10	0.3583	115.0	175.0	9.10
A94023/64	23/64	9.13	0.3594	108.0	171.0	9.13
A9409.2	–	9.20	0.3622	115.0	175.0	9.20
A9409.3	–	9.30	0.3661	115.0	175.0	9.30
A9409.4	–	9.40	0.3701	115.0	175.0	9.40

Produkt	DC	DC	DC	LCF	OAL	D CON MS
	(inch)	(mm)	(inch)	(mm)	(mm)	(mm)
A9409.5	–	9.50	0.3740	115.0	175.0	9.50
A9403/8	3/8	9.52	0.3750	108.0	171.0	9.52
A9409.6	–	9.60	0.3780	121.0	184.0	9.60
A9409.7	–	9.70	0.3819	121.0	184.0	9.70
A9409.8	–	9.80	0.3858	121.0	184.0	9.80
A9409.9	–	9.90	0.3898	121.0	184.0	9.90
A94025/64	25/64	9.92	0.3906	111.0	178.0	9.92
A94010.0	–	10.00	0.3937	121.0	184.0	10.00
A94010.2	–	10.20	0.4016	121.0	184.0	10.20
A94010.3	–	10.30	0.4055	121.0	184.0	10.30
A94013/32	13/32	10.32	0.4063	111.0	178.0	10.32
A94010.5	–	10.50	0.4134	121.0	184.0	10.50
A94027/64	27/64	10.72	0.4219	117.0	184.0	10.72
A94011.0	–	11.00	0.4331	128.0	195.0	11.00
A9407/16	7/16	11.11	0.4375	117.0	184.0	11.11
A94011.2	–	11.20	0.4409	128.0	195.0	11.20
A94011.5	–	11.50	0.4528	128.0	195.0	11.50
A94029/64	29/64	11.51	0.4531	121.0	190.0	11.51
A94011.8	–	11.80	0.4646	128.0	195.0	11.80
A94015/32	15/32	11.91	0.4688	121.0	190.0	11.91
A94012.0	–	12.00	0.4724	134.0	205.0	12.00
A94012.2	–	12.20	0.4803	134.0	205.0	12.20
A94031/64	31/64	12.30	0.4844	121.0	197.0	12.30
A94012.5	–	12.50	0.4921	134.0	205.0	12.50
A9401/2	1/2	12.70	0.5000	121.0	197.0	12.70
A94013.0	–	13.00	0.5118	134.0	205.0	13.00
A94033/64	33/64	13.10	0.5156	121.0	203.0	13.10
A94017/32	17/32	13.49	0.5313	121.0	203.0	13.49
A94013.5	–	13.50	0.5315	140.0	214.0	13.50
A94035/64	35/64	13.89	0.5469	124.0	210.0	13.89
A94014.0	–	14.00	0.5512	140.0	214.0	14.00
A9409/16	9/16	14.29	0.5625	124.0	210.0	14.29
A94014.5	–	14.50	0.5709	144.0	220.0	14.50
A94037/64	37/64	14.68	0.5781	124.0	222.0	14.68
A94015.0	–	15.00	0.5906	144.0	220.0	15.00
A94019/32	19/32	15.08	0.5938	124.0	222.0	15.08
A94039/64	39/64	15.48	0.6094	124.0	222.0	15.48
A94015.5	–	15.50	0.6102	149.0	227.0	15.50
A9405/8	5/8	15.88	0.6250	124.0	222.0	15.88
A94016.0	–	16.00	0.6299	149.0	227.0	16.00
A94041/64	41/64	16.27	0.6406	130.0	229.0	16.27
A94016.5	–	16.50	0.6496	154.0	235.0	16.50
A94021/32	21/32	16.67	0.6563	130.0	229.0	16.67
A94017.0	–	17.00	0.6693	154.0	235.0	17.00
A94043/64	43/64	17.07	0.6719	137.0	235.0	17.07
A94011/16	11/16	17.46	0.6875	137.0	235.0	17.46
A94017.5	–	17.50	0.6890	158.0	241.0	17.50
A94045/64	45/64	17.86	0.7031	143.0	241.0	17.86
A94018.0	–	18.00	0.7087	158.0	241.0	18.00
A94023/32	23/32	18.26	0.7188	143.0	241.0	18.26
A94047/64	47/64	18.65	0.7344	149.0	248.0	18.65
A94019.0	–	19.00	0.7480	162.0	247.0	19.00
A9403/4	3/4	19.05	0.7500	149.0	248.0	19.05
A94049/64	49/64	19.45	0.7656	152.0	251.0	19.45
A94025/32	25/32	19.84	0.7813	152.0	251.0	19.84
A94020.0	–	20.00	0.7874	166.0	254.0	20.00



A941



PFX HSS-E (5 % kobaltu) Vrták dlouhý, Povlak Alcrona

Produktivní vrták pro kvalitní a přesné otvory, vhodný pro vysoké rezní rychlosti a velké posuvy (tolerance otvorů H10). Vrcholový úhel 130° a speciální parabolická drážka usnadňuje vrtání hlubokých otvorů v jednom kroku. Vhodný pro širokou oblast obráběných materiálů. Povlak Alcrona zvyšuje produktivitu a prodlužuje životnost.



PFX

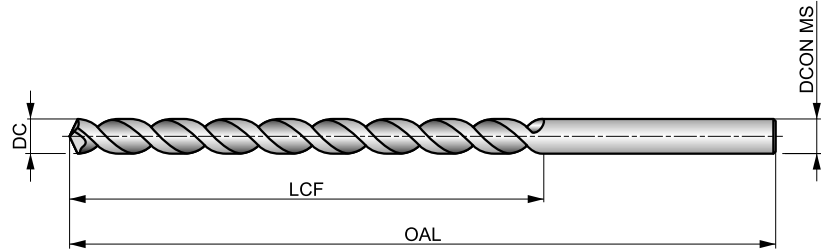

HSS-E	DIN ANSI	10xD
130°	Alcrona Top	
λ>35°	R	DC h8

Skupiny obráběných materiálů, startovní rezní rychlost (Vc m/min) a kód posuvu. Tabulku s posuvem na otáčku naleznete od strany 175.

P1.1 ■ 48 G	P1.2 ■ 53 G	P1.3 ■ 55 G	P2.1 ■ 41 G	P2.2 ■ 36 G	P2.3 ■ 32 D	P3.1 ■ 34 G	P3.2 ■ 27 G	P3.3 ■ 23 D	P4.1 ■ 20 G	P4.2 ■ 17 D	P4.3 ■ 14 D	M1.1 ■ 23 C	M1.2 ■ 20 C
M2.1 ■ 21 C	M2.2 ■ 17 C	M3.1 ■ 10 E	M3.2 ■ 9 E	M3.3 ■ 8 E	M4.1 ■ 11 B	K1.1 ■ 36 I	K1.2 ■ 27 I	K1.3 ■ 20 I	K2.1 ■ 37 I	K2.2 ■ 30 I	K2.3 ■ 24 H	K3.1 ■ 33 I	K3.2 ■ 25 I
K3.3 ■ 20 H	K4.1 ■ 30 I	K4.2 ■ 23 I	K4.3 ■ 17 H	K4.4 ■ 14 H	K4.5 ■ 12 H	K5.1 ■ 34 I	K5.2 ■ 26 I	K5.3 ■ 20 H	S1.1 ■ 25 F	S1.2 ■ 18 D	S1.3 ■ 18 D		

DC >= 9.6mm - kratší než 10xD.

Produkt	DC	DC	DC	LCF	OAL	DCON MS
	(inch)	(mm)	(inch)			
A9411.0	-	1.00	0.0394	33.0	56.0	1.00
A9413/64	3/64	1.19	0.0469	29.0	57.0	1.19
A9411.5	-	1.50	0.0591	45.0	70.0	1.50
A9411/16	1/16	1.59	0.0625	44.0	76.0	1.59
A9415/64	5/64	1.98	0.0781	51.0	95.0	1.98
A9412.0	-	2.00	0.0787	56.0	85.0	2.00
A9413/32	3/32	2.38	0.0938	57.0	108.0	2.38
A9412.5	-	2.50	0.0984	62.0	95.0	2.50
A9417/64	7/64	2.78	0.1094	64.0	117.0	2.78
A9413.0	-	3.00	0.1181	66.0	100.0	3.00
A9413.1	-	3.10	0.1220	69.0	106.0	3.10
A9411/8	1/8	3.18	0.1250	70.0	130.0	3.18
A9413.2	-	3.20	0.1260	69.0	106.0	3.20
A9413.3	-	3.30	0.1299	69.0	106.0	3.30
A9413.4	-	3.40	0.1339	73.0	112.0	3.40
A9413.5	-	3.50	0.1378	73.0	112.0	3.50
A9419/64	9/64	3.57	0.1406	76.0	137.0	3.57
A9413.6	-	3.60	0.1417	73.0	112.0	3.60
A9413.7	-	3.70	0.1457	73.0	112.0	3.70
A9413.8	-	3.80	0.1496	78.0	119.0	3.80
A9413.9	-	3.90	0.1535	78.0	119.0	3.90
A9415/32	5/32	3.97	0.1563	76.0	137.0	3.97
A9414.0	-	4.00	0.1575	78.0	119.0	4.00
A9414.1	-	4.10	0.1614	78.0	119.0	4.10
A9414.2	-	4.20	0.1654	78.0	119.0	4.20
A9414.3	-	4.30	0.1693	82.0	126.0	4.30
A94111/64	11/64	4.37	0.1719	86.0	146.0	4.37

Produkt	DC	DC	DC	LCF	OAL	DCON MS
	(inch)	(mm)	(inch)			
A9414.4	-	4.40	0.1732	82.0	126.0	4.40
A9414.5	-	4.50	0.1772	82.0	126.0	4.50
A9414.6	-	4.60	0.1811	82.0	126.0	4.60
A9414.7	-	4.70	0.1850	82.0	126.0	4.70
A9413/16	3/16	4.76	0.1875	86.0	146.0	4.76
A9414.8	-	4.80	0.1890	87.0	132.0	4.80
A9414.9	-	4.90	0.1929	87.0	132.0	4.90
A9415.0	-	5.00	0.1969	87.0	132.0	5.00
A9415.1	-	5.10	0.2008	87.0	132.0	5.10
A94113/64	13/64	5.16	0.2031	92.0	152.0	5.16
A9415.2	-	5.20	0.2047	87.0	132.0	5.20
A9415.3	-	5.30	0.2087	87.0	132.0	5.30
A9415.4	-	5.40	0.2126	91.0	139.0	5.40
A9415.5	-	5.50	0.2165	91.0	139.0	5.50
A9417/32	7/32	5.56	0.2188	92.0	152.0	5.56
A9415.6	-	5.60	0.2205	91.0	139.0	5.60
A9415.7	-	5.70	0.2244	91.0	139.0	5.70
A9415.8	-	5.80	0.2283	91.0	139.0	5.80
A9415.9	-	5.90	0.2323	91.0	139.0	5.90
A94115/64	15/64	5.95	0.2344	95.0	156.0	5.95
A9416.0	-	6.00	0.2362	91.0	139.0	6.00
A9416.1	-	6.10	0.2402	97.0	148.0	6.10
A9416.2	-	6.20	0.2441	97.0	148.0	6.20
A9416.3	-	6.30	0.2480	97.0	148.0	6.30
A9411/4	1/4	6.35	0.2500	95.0	156.0	6.35
A9416.4	-	6.40	0.2520	97.0	148.0	6.40
A9416.5	-	6.50	0.2559	97.0	148.0	6.50



Produkt	DC	DC	DC	LCF	OAL	DCON MS
	(inch)	(mm)	(inch)	(mm)	(mm)	(mm)
A9416.6	–	6.60	0.2598	97.0	148.0	6.60
A9416.7	–	6.70	0.2638	97.0	148.0	6.70
A94117/64	17/64	6.75	0.2656	98.0	159.0	6.75
A9416.8	–	6.80	0.2677	102.0	156.0	6.80
A9416.9	–	6.90	0.2717	102.0	156.0	6.90
A9417.0	–	7.00	0.2756	102.0	156.0	7.00
A9417.1	–	7.10	0.2795	102.0	156.0	7.10
A9419/32	9/32	7.14	0.2813	98.0	159.0	7.14
A9417.2	–	7.20	0.2835	102.0	156.0	7.20
A9417.3	–	7.30	0.2874	102.0	156.0	7.30
A9417.4	–	7.40	0.2913	102.0	156.0	7.40
A9417.5	–	7.50	0.2953	102.0	156.0	7.50
A94119/64	19/64	7.54	0.2969	102.0	162.0	7.54
A9417.6	–	7.60	0.2992	109.0	165.0	7.60
A9417.7	–	7.70	0.3031	109.0	165.0	7.70
A9417.8	–	7.80	0.3071	109.0	165.0	7.80
A9417.9	–	7.90	0.3110	109.0	165.0	7.90
A9415/16	5/16	7.94	0.3125	102.0	162.0	7.94
A9418.0	–	8.00	0.3150	109.0	165.0	8.00
A9418.1	–	8.10	0.3189	109.0	165.0	8.10
A9418.2	–	8.20	0.3228	109.0	165.0	8.20
A9418.3	–	8.30	0.3268	109.0	165.0	8.30
A94121/64	21/64	8.33	0.3281	105.0	165.0	8.33
A9418.4	–	8.40	0.3307	109.0	165.0	8.40
A9418.5	–	8.50	0.3346	109.0	165.0	8.50
A9418.6	–	8.60	0.3386	115.0	175.0	8.60
A9418.7	–	8.70	0.3425	115.0	175.0	8.70
A94111/32	11/32	8.73	0.3438	105.0	165.0	8.73
A9418.8	–	8.80	0.3465	115.0	175.0	8.80
A9418.9	–	8.90	0.3504	115.0	175.0	8.90
A9419.0	–	9.00	0.3543	115.0	175.0	9.00
A9419.1	–	9.10	0.3583	115.0	175.0	9.10
A94123/64	23/64	9.13	0.3594	108.0	171.0	9.13
A9419.2	–	9.20	0.3622	115.0	175.0	9.20
A9419.3	–	9.30	0.3661	115.0	175.0	9.30
A9419.4	–	9.40	0.3701	115.0	175.0	9.40
A9419.5	–	9.50	0.3740	115.0	175.0	9.50
A9413/8	3/8	9.52	0.3750	108.0	171.0	9.52

Produkt	DC	DC	DC	LCF	OAL	DCON MS
	(inch)	(mm)	(inch)	(mm)	(mm)	(mm)
A9419.6	–	9.60	0.3780	121.0	184.0	9.60
A9419.7	–	9.70	0.3819	121.0	184.0	9.70
A9419.8	–	9.80	0.3858	121.0	184.0	9.80
A9419.9	–	9.90	0.3898	121.0	184.0	9.90
A94125/64	25/64	9.92	0.3906	111.0	178.0	9.92
A94110.0	–	10.00	0.3937	121.0	184.0	10.00
A94110.2	–	10.20	0.4016	121.0	184.0	10.20
A94110.3	–	10.30	0.4055	121.0	184.0	10.30
A94113/32	13/32	10.32	0.4063	111.0	178.0	10.32
A94110.5	–	10.50	0.4134	121.0	184.0	10.50
A94127/64	27/64	10.72	0.4219	117.0	184.0	10.72
A94111.0	–	11.00	0.4331	128.0	195.0	11.00
A9417/16	7/16	11.11	0.4375	117.0	184.0	11.11
A94111.2	–	11.20	0.4409	128.0	195.0	11.20
A94111.5	–	11.50	0.4528	128.0	195.0	11.50
A94129/64	29/64	11.51	0.4531	121.0	190.0	11.51
A94111.8	–	11.80	0.4646	128.0	195.0	11.80
A94115/32	15/32	11.91	0.4688	121.0	190.0	11.91
A94112.0	–	12.00	0.4724	134.0	205.0	12.00
A94112.2	–	12.20	0.4803	134.0	205.0	12.20
A94131/64	31/64	12.30	0.4844	121.0	197.0	12.30
A94112.5	–	12.50	0.4921	134.0	205.0	12.50
A9411/2	1/2	12.70	0.5000	121.0	197.0	12.70
A94113.0	–	13.00	0.5118	134.0	205.0	13.00
A94133/64	33/64	13.10	0.5156	121.0	203.0	13.10
A94113.5	–	13.50	0.5315	140.0	214.0	13.50
A94135/64	35/64	13.89	0.5469	124.0	210.0	13.89
A94114.0	–	14.00	0.5512	140.0	214.0	14.00
A9419/16	9/16	14.29	0.5625	124.0	210.0	14.29
A94114.5	–	14.50	0.5709	144.0	220.0	14.50
A94137/64	37/64	14.68	0.5781	124.0	222.0	14.68
A94115.0	–	15.00	0.5906	144.0	220.0	15.00
A94119/32	19/32	15.08	0.5938	124.0	222.0	15.08
A94139/64	39/64	15.48	0.6094	124.0	222.0	15.48
A94115.5	–	15.50	0.6102	149.0	227.0	15.50
A9415/8	5/8	15.88	0.6250	124.0	222.0	15.88
A94116.0	–	16.00	0.6299	149.0	227.0	16.00



A125



HSS Vrták, Extra dlouhý, Parní temperace povrchu

Pro vrtání velmi hlubokých otvorů a vrtání v nedostupných místech. Vrcholový úhel vrtáku 118° pro dosažení pevného břitu a snadné a ekonomické přebrušování. Vhodný pro vrtání mnoha materiálů. Parní temperace povrchu zadržuje řeznou kapalinu a brání nalepování třísek. Méně vhodný pro ruční operace.

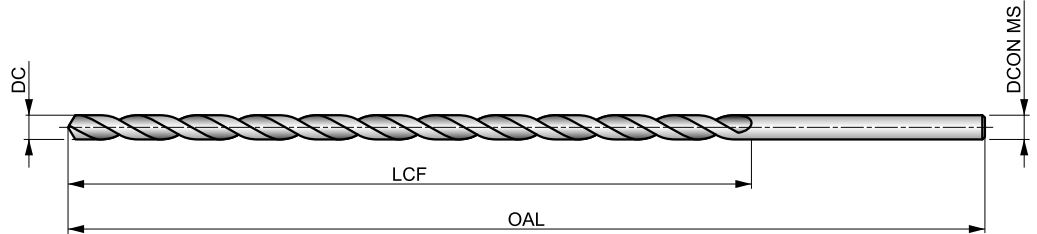

HSS	BS 328	10×D
118°	ST	
λ 20-35°	R	DC h8

Skupiny obráběných materiálů, startovní řezná rychlost (Vc m/min) a kód posuvu. Tabulku s posuvem na otáčku naleznete od strany 175.

P1.1 ■ 21 E	P1.2 ■ 24 E	P1.3 ■ 25 E	P2.1 ■ 18 E	P2.2 ■ 16 C	P2.3 ■ 14 A	P3.1 ■ 9 C	P3.2 ■ 7 C	P3.3 ■ 6 A	P4.1 ■ 5 C	P4.2 ■ 4 A	P4.3 ■ 4 A	M1.1 ■ 12 C	M1.2 ■ 10 C
M2.1 ■ 11 C	M2.2 ■ 9 C	M3.1 ■ 5 E	M3.2 ■ 4 E	M3.3 ■ 4 E	M4.1 ■ 8 A	K1.1 ■ 22 G	K1.2 ■ 16 D	K1.3 ■ 12 D	K2.1 ■ 16 C	K2.2 ■ 13 C	K2.3 ■ 10 C	K3.1 ■ 14 C	K3.2 ■ 11 C
K3.3 ■ 9 C	K4.1 ■ 13 C	K4.2 ■ 10 C	K4.3 ■ 7 C	K4.4 ■ 6 C	K4.5 ■ 5 C	K5.1 ■ 15 C	K5.2 ■ 11 C	K5.3 ■ 9 C	N1.1 ■ 24 H	N1.2 ■ 18 H	N1.3 ■ 12 G	N2.1 ■ 34 F	N2.2 ■ 30 F
N2.3 ■ 22 F	N3.1 ■ 56 F	N3.2 ■ 33 G	N3.3 ■ 17 D	N4.1 ■ 30 H	N4.2 ■ 26 F	N4.3 ■ 10 D	S1.1 ■ 11 D	S1.2 ■ 9 B	S1.3 ■ 5 A	S2.1 ■ 5 C	S2.2 ■ 4 A	S3.1 ■ 4 C	S3.2 ■ 3 A
S4.1 ■ 3 C	S4.2 ■ 2 A												

DC <= 2.2mm (5/64") - leštěný.

Produkt	DC (inch)	DC (mm)	DC (inch)	LCF (mm)	OAL (mm)	DCON MS (mm)
A1251.4X160	-	1.40	0.0551	100.0	160.0	1.40
A1251.5X125	-	1.50	0.0591	80.0	125.0	1.50
A1251.5X160	-	1.50	0.0591	100.0	160.0	1.50
A1251/16X125	1/16	1.59	0.0625	80.0	125.0	1.59
A1251/16X160	1/16	1.59	0.0625	100.0	160.0	1.59
A1251.8X160	-	1.80	0.0709	100.0	160.0	1.80
A1255/64X125	5/64	1.98	0.0781	80.0	125.0	1.98
A1255/64X160	5/64	1.98	0.0781	100.0	160.0	1.98
A1252.0X125	-	2.00	0.0787	80.0	125.0	2.00
A1252.0X160	-	2.00	0.0787	100.0	160.0	2.00
A1252.2X160	-	2.20	0.0866	100.0	160.0	2.20
A1253/32X125	3/32	2.38	0.0938	80.0	125.0	2.38
A1253/32X160	3/32	2.38	0.0938	100.0	160.0	2.38
A1252.5X125	-	2.50	0.0984	80.0	125.0	2.50
A1252.5X160	-	2.50	0.0984	100.0	160.0	2.50
A1257/64X125	7/64	2.78	0.1094	80.0	125.0	2.78
A1257/64X160	7/64	2.78	0.1094	100.0	160.0	2.78
A1253.0X160	-	3.00	0.1181	100.0	160.0	3.00
A1253.0X200	-	3.00	0.1181	150.0	200.0	3.00
A1253.0X250	-	3.00	0.1181	200.0	250.0	3.00
A1251/8X160	1/8	3.18	0.1252	100.0	160.0	3.18
A1251/8X200	1/8	3.18	0.1252	150.0	200.0	3.18
A1251/8X250	1/8	3.18	0.1252	200.0	250.0	3.18
A1251/8X315	1/8	3.18	0.1252	250.0	310.0	3.18
A1253.3X160	-	3.30	0.1299	100.0	160.0	3.30
A1253.5X160	-	3.50	0.1378	100.0	160.0	3.50

Produkt	DC (inch)	DC (mm)	DC (inch)	LCF (mm)	OAL (mm)	DCON MS (mm)
A1253.5X200	-	3.50	0.1378	150.0	200.0	3.50
A1253.5X250	-	3.50	0.1378	200.0	250.0	3.50
A1259/64X160	9/64	3.57	0.1406	100.0	160.0	3.57
A1259/64X200	9/64	3.57	0.1406	150.0	200.0	3.57
A1259/64X315	9/64	3.57	0.1406	250.0	310.0	3.57
A1255/32X160	5/32	3.97	0.1563	100.0	160.0	3.97
A1255/32X200	5/32	3.97	0.1563	150.0	200.0	3.97
A1255/32X250	5/32	3.97	0.1563	200.0	250.0	3.97
A1255/32X315	5/32	3.97	0.1563	250.0	310.0	3.97
A1254.0X160	-	4.00	0.1575	100.0	160.0	4.00
A1254.0X200	-	4.00	0.1575	150.0	200.0	4.00
A1254.0X250	-	4.00	0.1575	200.0	250.0	4.00
A1254.0X315	-	4.00	0.1575	250.0	310.0	4.00
A12511/64X160	11/64	4.37	0.1719	100.0	160.0	4.37
A12511/64X200	11/64	4.37	0.1719	150.0	200.0	4.37
A12511/64X315	11/64	4.37	0.1719	250.0	310.0	4.37
A1254.5X160	-	4.50	0.1772	100.0	160.0	4.50
A1254.5X200	-	4.50	0.1772	150.0	200.0	4.50
A1254.5X250	-	4.50	0.1772	200.0	250.0	4.50
A1254.5X315	-	4.50	0.1772	250.0	310.0	4.50
A1253/16X160	3/16	4.76	0.1875	100.0	160.0	4.76
A1253/16X200	3/16	4.76	0.1875	150.0	200.0	4.76
A1253/16X250	3/16	4.76	0.1875	200.0	250.0	4.76
A1253/16X315	3/16	4.76	0.1875	250.0	310.0	4.76
A1253/16X400	3/16	4.76	0.1875	300.0	400.0	4.76
A1255.0X160	-	5.00	0.1969	100.0	160.0	5.00



Produkt	DC	DC	DC	LCF	OAL	DCON MS
	(inch)	(mm)	(inch)	(mm)	(mm)	(mm)
A1255.0X200	–	5.00	0.1969	150.0	200.0	5.00
A1255.0X250	–	5.00	0.1969	200.0	250.0	5.00
A1255.0X315	–	5.00	0.1969	250.0	310.0	5.00
A1255.0X400	–	5.00	0.1969	300.0	400.0	5.00
A12513/64X200	13/64	5.16	0.2031	150.0	200.0	5.16
A12513/64X250	13/64	5.16	0.2031	200.0	250.0	5.16
A12513/64X315	13/64	5.16	0.2031	250.0	310.0	5.16
A1255.5X200	–	5.50	0.2165	150.0	200.0	5.50
A1255.5X250	–	5.50	0.2165	200.0	250.0	5.50
A1255.5X315	–	5.50	0.2165	250.0	310.0	5.50
A1257/32X200	7/32	5.56	0.2188	150.0	200.0	5.56
A1257/32X250	7/32	5.56	0.2188	200.0	250.0	5.56
A1257/32X315	7/32	5.56	0.2188	250.0	310.0	5.56
A12515/64X200	15/64	5.95	0.2344	150.0	200.0	5.95
A12515/64X250	15/64	5.95	0.2344	200.0	250.0	5.95
A12515/64X315	15/64	5.95	0.2344	250.0	310.0	5.95
A1256.0X200	–	6.00	0.2362	150.0	200.0	6.00
A1256.0X250	–	6.00	0.2362	200.0	250.0	6.00
A1256.0X315	–	6.00	0.2362	250.0	310.0	6.00
A1256.0X400	–	6.00	0.2362	300.0	400.0	6.00
A1251/4X200	1/4	6.35	0.2500	150.0	200.0	6.35
A1251/4X250	1/4	6.35	0.2500	200.0	250.0	6.35
A1251/4X315	1/4	6.35	0.2500	250.0	310.0	6.35
A1251/4X400	1/4	6.35	0.2500	300.0	400.0	6.35
A1251/4X500	1/4	6.35	0.2500	400.0	460.0	6.35
A1256.5X200	–	6.50	0.2559	150.0	200.0	6.50
A1256.5X250	–	6.50	0.2559	200.0	250.0	6.50
A1256.5X315	–	6.50	0.2559	250.0	310.0	6.50
A12517/64X200	17/64	6.75	0.2656	150.0	200.0	6.75
A12517/64X250	17/64	6.75	0.2656	200.0	250.0	6.75
A12517/64X500	17/64	6.75	0.2656	400.0	460.0	6.75
A1257.0X200	–	7.00	0.2756	150.0	200.0	7.00
A1257.0X250	–	7.00	0.2756	200.0	250.0	7.00
A1257.0X315	–	7.00	0.2756	250.0	310.0	7.00
A1259/32X200	9/32	7.14	0.2813	150.0	200.0	7.14
A1259/32X250	9/32	7.14	0.2813	200.0	250.0	7.14
A1259/32X315	9/32	7.14	0.2813	250.0	310.0	7.14
A1259/32X500	9/32	7.14	0.2813	400.0	460.0	7.14
A1257.5X200	–	7.50	0.2953	150.0	200.0	7.50
A1257.5X250	–	7.50	0.2953	200.0	250.0	7.50
A1257.5X315	–	7.50	0.2953	250.0	310.0	7.50
A12519/64X315	19/64	7.54	0.2969	250.0	310.0	7.54
A12519/64X500	19/64	7.54	0.2969	400.0	460.0	7.54
A1255/16X200	5/16	7.94	0.3125	150.0	200.0	7.94
A1255/16X250	5/16	7.94	0.3125	200.0	250.0	7.94
A1255/16X315	5/16	7.94	0.3125	250.0	310.0	7.94
A1255/16X400	5/16	7.94	0.3125	300.0	400.0	7.94
A1255/16X500	5/16	7.94	0.3125	400.0	460.0	7.94
A1258.0X250	–	8.00	0.3150	200.0	250.0	8.00
A1258.0X315	–	8.00	0.3150	250.0	310.0	8.00
A1258.0X400	–	8.00	0.3150	300.0	400.0	8.00
A12521/64X315	21/64	8.33	0.3281	250.0	310.0	8.33
A12521/64X500	21/64	8.33	0.3281	400.0	460.0	8.33
A1258.5X250	–	8.50	0.3346	200.0	250.0	8.50
A1258.5X315	–	8.50	0.3346	250.0	310.0	8.50
A12511/32X250	11/32	8.73	0.3438	200.0	250.0	8.73
A12511/32X315	11/32	8.73	0.3438	250.0	310.0	8.73
A12511/32X400	11/32	8.73	0.3438	300.0	400.0	8.73
A12511/32X500	11/32	8.73	0.3438	400.0	460.0	8.73
A1259.0X250	–	9.00	0.3543	200.0	250.0	9.00
A1259.0X315	–	9.00	0.3543	250.0	310.0	9.00
A1259.0X400	–	9.00	0.3543	300.0	400.0	9.00
A12523/64X315	23/64	9.13	0.3594	250.0	310.0	9.13
A12523/64X500	23/64	9.13	0.3594	400.0	460.0	9.13
A1259.5X250	–	9.50	0.3740	200.0	250.0	9.50
A1259.5X315	–	9.50	0.3740	250.0	310.0	9.50
A1253/8X250	3/8	9.52	0.3750	200.0	250.0	9.52
A1253/8X315	3/8	9.52	0.3750	250.0	310.0	9.52
A1253/8X400	3/8	9.52	0.3750	300.0	400.0	9.52

Produkt	DC	DC	DC	LCF	OAL	DCON MS
	(inch)	(mm)	(inch)	(mm)	(mm)	(mm)
A1253/8X500	3/8	9.52	0.3750	400.0	460.0	9.52
A12525/64X315	25/64	9.92	0.3906	250.0	310.0	9.92
A12525/64X500	25/64	9.92	0.3906	400.0	460.0	9.92
A12510.0X250	–	10.00	0.3937	200.0	250.0	10.00
A12510.0X315	–	10.00	0.3937	250.0	310.0	10.00
A12510.0X400	–	10.00	0.3937	300.0	400.0	10.00
A12513/32X250	13/32	10.32	0.4063	200.0	250.0	10.32
A12513/32X315	13/32	10.32	0.4063	250.0	310.0	10.32
A12513/32X500	13/32	10.32	0.4063	400.0	460.0	10.32
A12510.5X250	–	10.50	0.4134	200.0	250.0	10.50
A12510.5X315	–	10.50	0.4134	250.0	310.0	10.50
A12510.5X400	–	10.50	0.4134	300.0	400.0	10.50
A12527/64X315	27/64	10.72	0.4219	250.0	310.0	10.72
A12511.0X250	–	11.00	0.4331	200.0	250.0	11.00
A12511.0X315	–	11.00	0.4331	250.0	310.0	11.00
A12511.0X400	–	11.00	0.4331	300.0	400.0	11.00
A1257/16X250	7/16	11.11	0.4375	200.0	250.0	11.11
A1257/16X315	7/16	11.11	0.4375	250.0	310.0	11.11
A1257/16X400	7/16	11.11	0.4375	300.0	400.0	11.11
A1257/16X500	7/16	11.11	0.4375	400.0	460.0	11.11
A12529/64X315	29/64	11.51	0.4531	250.0	310.0	11.51
A12529/64X500	29/64	11.51	0.4531	400.0	460.0	11.51
A12515/32X250	15/32	11.91	0.4688	200.0	250.0	11.91
A12515/32X315	15/32	11.91	0.4688	250.0	310.0	11.91
A12515/32X500	15/32	11.91	0.4688	400.0	460.0	11.91
A12512.0X250	–	12.00	0.4724	200.0	250.0	12.00
A12512.0X315	–	12.00	0.4724	250.0	310.0	12.00
A12512.0X400	–	12.00	0.4724	300.0	400.0	12.00
A12531/64X315	31/64	12.30	0.4844	250.0	310.0	12.30
A12531/64X500	31/64	12.30	0.4844	400.0	460.0	12.30
A1251/2X250	1/2	12.70	0.5000	200.0	250.0	12.70
A1251/2X315	1/2	12.70	0.5000	250.0	310.0	12.70
A1251/2X400	1/2	12.70	0.5000	300.0	400.0	12.70
A1251/2X500	1/2	12.70	0.5000	400.0	460.0	12.70
A12513.0X315	–	13.00	0.5118	250.0	310.0	13.00
A12513.0X400	–	13.00	0.5118	300.0	400.0	13.00
A12533/64X315	33/64	13.10	0.5156	250.0	310.0	13.10
A12533/64X500	33/64	13.10	0.5156	400.0	460.0	13.10
A12517/32X315	17/32	13.49	0.5313	250.0	310.0	13.49
A12517/32X500	17/32	13.49	0.5313	400.0	460.0	13.49
A12535/64X315	35/64	13.89	0.5469	250.0	310.0	13.89
A12535/64X500	35/64	13.89	0.5469	400.0	460.0	13.89
A12514.0X315	–	14.00	0.5512	250.0	310.0	14.00
A12514.0X400	–	14.00	0.5512	300.0	400.0	14.00
A1259/16X315	9/16	14.29	0.5625	250.0	310.0	14.29
A1259/16X500	9/16	14.29	0.5625	400.0	460.0	14.29
A12537/64X315	37/64	14.68	0.5781	250.0	310.0	14.68
A12519/32X315	19/32	15.08	0.5938	250.0	310.0	15.08
A12519/32X500	19/32	15.08	0.5938	400.0	460.0	15.08
A12539/64X315	39/64	15.48	0.6094	250.0	310.0	15.48
A12539/64X500	39/64	15.48	0.6094	400.0	460.0	15.48
A1255/8X315	5/8	15.88	0.6250	250.0	310.0	15.88
A1255/8X500	5/8	15.88	0.6250	400.0	460.0	15.88
A12521/32X315	21/32	16.67	0.6563	250.0	310.0	16.67
A12521/32X500	21/32	16.67	0.6563	400.0	460.0	16.67
A12511/16X315	11/16	17.46	0.6875	250.0	310.0	17.46
A12511/16X500	11/16	17.46	0.6875	400.0	460.0	17.46
A12523/32X315	23/32	18.26	0.7188	250.0	310.0	18.26
A12523/32X500	23/32	18.26	0.7188	400.0	460.0	18.26
A1253/4X315	3/4	19.05	0.7500	250.0	310.0	19.05
A1253/4X500	3/4	19.05	0.7500	400.0	460.0	19.05
A12525/32X500	25/32	19.84	0.7813	400.0	460.0	19.84
A12513/16X500	13/16	20.64	0.8125	400.0	460.0	20.64
A1257/8X500	7/8	22.22	0.8750	400.0	460.0	22.22
A12515/16X500	15/16	23.81	0.9375	400.0	460.0	23.81
A1251X500	1"	25.40	1.0000	400.0	460.0	25.40



A976



PFX HSS-E (5 % kobaltu) Vrták dlouhý (dle DIN 1869/1), Leštěný

Doporučen pro vrtání hlubokých otvorů nebo vrtání v těžko dostupných místech. Vrcholový úhel 130° a speciální parabolická drážka usnadňuje vrtání hlubokých otvorů v jednom kroku. Doporučeno vystředění krátkým 3xD PFX vrtákem (se stejnou tolerancí). Vhodný pro širokou oblast obráběných materiálů.



PFX

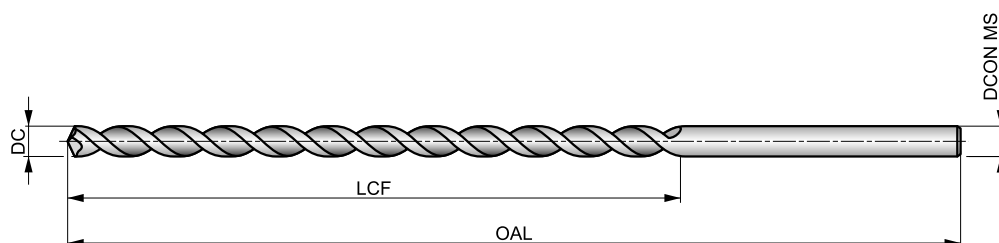

HSS-E	DIN 1869-1	15×D
130°	Bright	
λ>35°	R	DC h8

Skupiny obráběných materiálů, startovní řezná rychlost (Vc m/min) a kód posuvu. Tabulku s posuvem na otáčku naleznete od strany 175.

P1.1 ■29 C	P1.2 ■33 C	P1.3 ■34 C	P2.1 ■25 C	P2.2 ■22 C	P2.3 ■19 A	P3.1 ■18 C	P3.2 ■14 C	P3.3 ■12 A	P4.1 ■11 C	P4.2 ■9 A	P4.3 ■7 A	M1.1 ■16 B	M1.2 ■14 B
M2.1 ■15 B	M2.2 ■12 B	M3.1 ■8 C	M3.2 ■7 C	M3.3 ■6 C	M4.1 ■8 A	K2.1 ■20 C	K2.2 ■16 C	K2.3 ■13 A	K3.1 ■17 C	K3.2 ■13 C	K3.3 ■11 A	K4.1 ■16 C	K4.2 ■12 C
K4.3 ■9 A	K4.4 ■8 A	K4.5 ■6 A	K5.1 ■18 C	K5.2 ■14 C	K5.3 ■11 A	N3.1 ■30 D	S1.1 ■15 C	S1.2 ■11 A	S1.3 ■5 A				

Produkt	DC (inch)	DC (mm)	DC (inch)	LCF (mm)	OAL (mm)	DCON MS (mm)
A9761.5	–	1.50	0.0591	75.0	115.0	1.50
A9762.0X125	–	2.00	0.0787	85.0	125.0	2.00
A9762.1X125	–	2.10	0.0827	85.0	125.0	2.10
A9762.2X135	–	2.20	0.0866	90.0	135.0	2.20
A9762.3X135	–	2.30	0.0906	90.0	135.0	2.30
A9762.4X140	–	2.40	0.0945	95.0	140.0	2.40
A9762.5X140	–	2.50	0.0984	95.0	140.0	2.50
A9762.6X140	–	2.60	0.1024	95.0	140.0	2.60
A9762.7X150	–	2.70	0.1063	100.0	150.0	2.70
A9762.8X150	–	2.80	0.1102	100.0	150.0	2.80
A9762.9X150	–	2.90	0.1142	100.0	150.0	2.90
A9763.0X150	–	3.00	0.1181	100.0	150.0	3.00
A9763.1X155	–	3.10	0.1220	105.0	155.0	3.10
A9761/8	1/8	3.18	0.1252	105.0	155.0	3.18
A9763.2X155	–	3.20	0.1260	105.0	155.0	3.20
A9763.3X155	–	3.30	0.1299	105.0	155.0	3.30
A9763.4X165	–	3.40	0.1339	115.0	165.0	3.40
A9763.5X165	–	3.50	0.1378	115.0	165.0	3.50
A9763.6X165	–	3.60	0.1417	115.0	165.0	3.60
A9763.7X165	–	3.70	0.1457	115.0	165.0	3.70
A9763.8X175	–	3.80	0.1496	120.0	175.0	3.80
A9763.9X175	–	3.90	0.1535	120.0	175.0	3.90
A9765/32	5/32	3.97	0.1563	120.0	175.0	3.97
A9764.0X175	–	4.00	0.1575	120.0	175.0	4.00
A9764.1X175	–	4.10	0.1614	120.0	175.0	4.10
A9764.2X175	–	4.20	0.1654	120.0	175.0	4.20
A9764.3X185	–	4.30	0.1693	125.0	185.0	4.30
A9764.4X185	–	4.40	0.1732	125.0	185.0	4.40

Produkt	DC (inch)	DC (mm)	DC (inch)	LCF (mm)	OAL (mm)	DCON MS (mm)
A9764.5X185	–	4.50	0.1772	125.0	185.0	4.50
A9764.6X185	–	4.60	0.1811	125.0	185.0	4.60
A9764.7X185	–	4.70	0.1850	125.0	185.0	4.70
A9763/16	3/16	4.76	0.1875	135.0	195.0	4.76
A9764.8X195	–	4.80	0.1890	135.0	195.0	4.80
A9764.9X195	–	4.90	0.1929	135.0	195.0	4.90
A9765.0X195	–	5.00	0.1969	135.0	195.0	5.00
A9765.1X195	–	5.10	0.2008	135.0	195.0	5.10
A9765.2X195	–	5.20	0.2047	135.0	195.0	5.20
A9765.3X195	–	5.30	0.2087	135.0	195.0	5.30
A9765.4X205	–	5.40	0.2126	140.0	205.0	5.40
A9765.5X205	–	5.50	0.2165	140.0	205.0	5.50
A9765.6X205	–	5.60	0.2205	140.0	205.0	5.60
A9765.7X205	–	5.70	0.2244	140.0	205.0	5.70
A9765.8X205	–	5.80	0.2283	140.0	205.0	5.80
A9765.9X205	–	5.90	0.2323	140.0	205.0	5.90
A9766.0X205	–	6.00	0.2362	140.0	205.0	6.00
A9766.1X215	–	6.10	0.2402	150.0	215.0	6.10
A9766.2X215	–	6.20	0.2441	150.0	215.0	6.20
A9766.3X215	–	6.30	0.2480	150.0	215.0	6.30
A9761/4	1/4	6.35	0.2500	150.0	215.0	6.35
A9766.4X215	–	6.40	0.2520	150.0	215.0	6.40
A9766.5X215	–	6.50	0.2559	150.0	215.0	6.50
A9766.6X215	–	6.60	0.2598	150.0	215.0	6.60
A9766.7X215	–	6.70	0.2638	150.0	215.0	6.70
A9766.8X225	–	6.80	0.2677	155.0	225.0	6.80
A9766.9X225	–	6.90	0.2717	155.0	225.0	6.90
A9767.0X225	–	7.00	0.2756	155.0	225.0	7.00



Produkt	DC	DC	DC	LCF	OAL	DCON MS
	(inch)	(mm)	(inch)	(mm)	(mm)	(mm)
A9767.5X225	–	7.50	0.2953	155.0	225.0	7.50
A9765/16	5/16	7.94	0.3125	165.0	240.0	7.94
A9768.0X240	–	8.00	0.3150	165.0	240.0	8.00
A9768.5X240	–	8.50	0.3346	165.0	240.0	8.50
A97611/32	11/32	8.73	0.3438	175.0	250.0	8.73
A9769.0X250	–	9.00	0.3543	175.0	250.0	9.00
A9769.5X250	–	9.50	0.3740	175.0	250.0	9.50
A9763/8	3/8	9.52	0.3750	185.0	265.0	9.52
A97610.0X265	–	10.00	0.3937	185.0	265.0	10.00

¹⁾ Dormer standard.

Produkt	DC	DC	DC	LCF	OAL	DCON MS
	(inch)	(mm)	(inch)	(mm)	(mm)	(mm)
A97610.5	–	10.50	0.4134	185.0	265.0	10.50
A97611.0	–	11.00	0.4331	195.0	280.0	11.00
A9767/16	7/16	11.11	0.4375	195.0	280.0	11.11
A97611.5	–	11.50	0.4528	195.0	280.0	11.50
A97612.0	–	12.00	0.4724	205.0	295.0	12.00
A97612.5	–	12.50	0.4921	205.0	295.0	12.50
A9761/2	1/2	12.70	0.5000	205.0	295.0	12.70
A97613.0	–	13.00	0.5118	205.0	295.0	13.00
A97614.0 ¹⁾	–	14.00	0.5512	215.0	310.0	14.00



A977



PFX HSS-E (5 % kobaltu) Vrták dlouhý (dle DIN 1869/2), Leštěný

Doporučen pro vrtání hlubokých otvorů nebo vrtání v těžko dostupných místech. Vrcholový úhel 130° a speciální parabolická drážka usnadňuje vrtání hlubokých otvorů v jednom kroku. Doporučeno vystředění krátkým 3xD PFX vrtákem (se stejnou tolerancí). Vhodný pro širokou oblast obráběných materiálů.

PFX

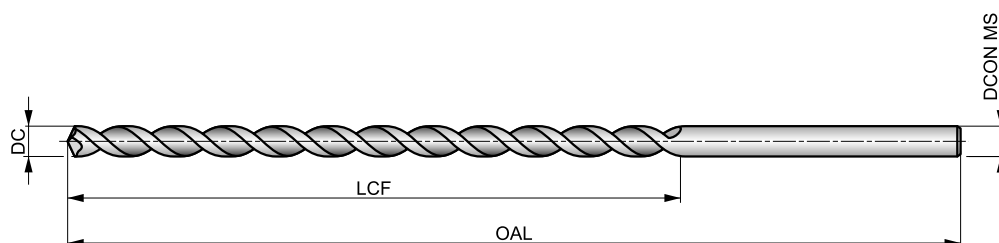

HSS-E	DIN 1869-2	20xD
130°	Bright	
$\lambda > 35^\circ$	R	DC h8

Skupiny obráběných materiálů, startovní řezná rychlost (Vc m/min) a kód posuvu. Tabulku s posuvem na otáčku naleznete od strany 175.

P1.1 ▣29 B	P1.2 ▣33 B	P1.3 ▣34 B	P2.1 ▣25 B	P2.2 ▣22 B	P2.3 ▣19 A	P3.1 ▣18 B	P3.2 ▣14 B	P3.3 ▣12 A	P4.1 ▣11 B	P4.2 ▣9 A	P4.3 ▣7 A	M1.1 ▣16 B	M1.2 ▣14 B
M2.1 ▣15 B	M2.2 ▣12 B	M3.1 ▣8 B	M3.2 ▣7 B	M3.3 ▣6 B	M4.1 ▣8 A	K2.1 ▣20 B	K2.2 ▣16 B	K2.3 ▣13 A	K3.1 ▣17 B	K3.2 ▣13 B	K3.3 ▣11 A	K4.1 ▣16 B	K4.2 ▣12 B
K4.3 ▣9 A	K4.4 ▣8 A	K4.5 ▣6 A	K5.1 ▣18 B	K5.2 ▣14 B	K5.3 ▣11 A	N3.1 ▣30 C	S1.1 ▣15 B	S1.2 ▣11 A	S1.3 ▣5 A				

Produkt	DC (inch)	DC (mm)	DC (inch)	LCF (mm)	OAL (mm)	DCON MS (mm)
A9771.5 ¹⁾	–	1.50	0.0591	100.0	150.0	1.50
A9771/16 ¹⁾	1/16	1.59	0.0625	100.0	150.0	1.59
A9772.0 ¹⁾	–	2.00	0.0787	110.0	160.0	2.00
A9773/32 ¹⁾	3/32	2.38	0.0938	115.0	170.0	2.38
A9773.0X190	–	3.00	0.1181	130.0	190.0	3.00
A9771/8	1/8	3.18	0.1250	135.0	200.0	3.18
A9773.5X210	–	3.50	0.1378	145.0	210.0	3.50
A9774.0X220	–	4.00	0.1575	150.0	220.0	4.00
A9774.5X235	–	4.50	0.1772	160.0	235.0	4.50
A9773/16	3/16	4.76	0.1875	170.0	245.0	4.76
A9775.0X245	–	5.00	0.1969	170.0	245.0	5.00
A9775.5X260	–	5.50	0.2165	180.0	260.0	5.50
A9776.0X260	–	6.00	0.2362	180.0	260.0	6.00
A9771/4	1/4	6.35	0.2500	190.0	275.0	6.35
A9776.5X275	–	6.50	0.2559	190.0	275.0	6.50

Produkt	DC (inch)	DC (mm)	DC (inch)	LCF (mm)	OAL (mm)	DCON MS (mm)
A9777.0X290	–	7.00	0.2756	200.0	290.0	7.00
A9777.5X290	–	7.50	0.2953	200.0	290.0	7.50
A9778.0X305	–	8.00	0.3150	210.0	305.0	8.00
A9778.5X305	–	8.50	0.3346	210.0	305.0	8.50
A97711/32	11/32	8.73	0.3438	220.0	320.0	8.73
A9779.0X320	–	9.00	0.3543	220.0	320.0	9.00
A9779.5X320	–	9.50	0.3740	220.0	320.0	9.50
A97710.0X340	–	10.00	0.3937	235.0	340.0	10.00
A97710.5	–	10.50	0.4134	235.0	340.0	10.50
A97711.0	–	11.00	0.4331	250.0	365.0	11.00
A97711.5	–	11.50	0.4528	250.0	365.0	11.50
A97712.0	–	12.00	0.4724	260.0	375.0	12.00
A97712.5	–	12.50	0.4921	260.0	375.0	12.50
A97713.0	–	13.00	0.5118	260.0	375.0	13.00
A97714.0 ¹⁾	–	14.00	0.5512	270.0	390.0	14.00

¹⁾ Dormer standard.



A978



PFX HSS-E (5 % kobaltu) Vrták dlouhý (dle DIN 1869/3), Leštěný

Doporučen pro vrtání hlubokých otvorů nebo vrtání v těžko dostupných místech. Vrcholový úhel 130° a speciální parabolická drážka usnadňuje vrtání hlubokých otvorů v jednom kroku. Doporučeno vystředění krátkým 3xD PFX vrtákem (se stejnou tolerancí). Vhodný pro širokou oblast obráběných materiálů.

PFX

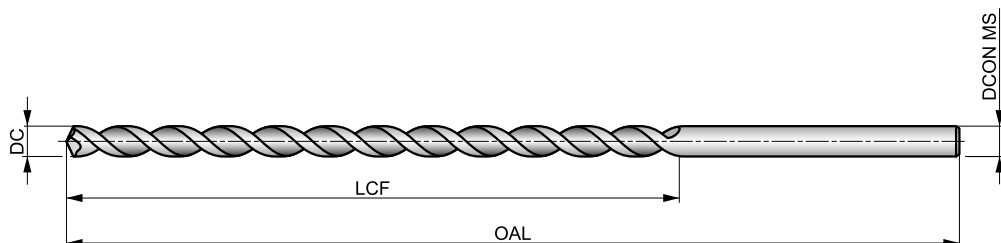

HSS-E	DIN 1869-3	25xD
130°	Bright	
$\lambda > 35^\circ$	R	DC h8

Skupiny obráběných materiálů, startovní řezná rychlost (Vc m/min) a kód posuvu. Tabulku s posuvem na otáčku naleznete od strany 175.

P1.1 ▣29 A	P1.2 ▣33 A	P1.3 ▣34 A	P2.1 ▣25 A	P2.2 ▣22 A	P2.3 ▣19 A	P3.1 ▣18 A	P3.2 ▣14 A	P3.3 ▣12 A	P4.1 ▣11 A	P4.2 ▣9 A	P4.3 ▣7 A	M1.1 ▣16 A	M1.2 ▣14 A
M2.1 ▣15 A	M2.2 ▣12 A	M3.1 ▣8 A	M3.2 ▣17 A	M3.3 ▣6 A	M4.1 ▣8 A	K2.1 ▣20 A	K2.2 ▣16 A	K2.3 ▣13 A	K3.1 ▣17 A	K3.2 ▣13 A	K3.3 ▣11 A	K4.1 ▣16 A	K4.2 ▣12 A
K4.3 ▣9 A	K4.4 ▣8 A	K4.5 ▣6 A	K5.1 ▣18 A	K5.2 ▣14 A	K5.3 ▣11 A	N3.1 ▣30 B	S1.1 ▣15 A	S1.2 ▣11 A	S1.3 ▣5 A				

Produkt	DC	DC	DC	LCF	OAL	DCON MS
	(inch)	(mm)	(inch)	(mm)	(mm)	(mm)
A9783.0 ¹⁾	–	3.00	0.1181	160.0	240.0	3.00
A9783.5X265	–	3.50	0.1378	180.0	265.0	3.50
A9784.0X280	–	4.00	0.1575	190.0	280.0	4.00
A9784.5X295	–	4.50	0.1772	200.0	295.0	4.50
A9785.0X315	–	5.00	0.1969	210.0	315.0	5.00
A9785.5X330	–	5.50	0.2165	225.0	330.0	5.50
A9786.0X330	–	6.00	0.2362	225.0	330.0	6.00
A9781/4	1/4	6.35	0.2500	235.0	350.0	6.35
A9786.5X350	–	6.50	0.2559	235.0	350.0	6.50
A9787.0X370	–	7.00	0.2756	250.0	370.0	7.00
A9787.5X370	–	7.50	0.2953	250.0	370.0	7.50
A9788.0X390	–	8.00	0.3150	265.0	390.0	8.00
A9788.5X390	–	8.50	0.3346	265.0	390.0	8.50
A9789.0X410	–	9.00	0.3543	280.0	410.0	9.00
A9789.5X410	–	9.50	0.3740	280.0	410.0	9.50
A97810.0X430	–	10.00	0.3937	295.0	430.0	10.00

¹⁾ Dormer standard.



A130



HSS Vrták s kuželovou stopkou, Parní temperace povrchu

Univerzální vrták s dostupnými velkými průměry až do 50.80mm (2 palce). Kuželová stopka pro tužší upnutí. Standardní vrcholový úhel vrtáku 118° pro odolnější břit a snazší přebrousování. Parní temperace povrchu zadržuje řeznou kapalinu a brání nalepování třísek. Vhodný pro širokou oblast obráběných materiálů.

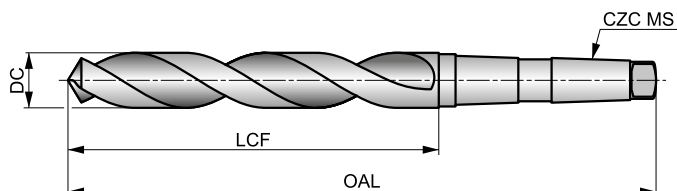

HSS	DIN 345	4xD
118°	ST	
λ 20-35°	R	DC h8

Skupiny obráběných materiálů, startovní řezná rychlost (Vc m/min) a kód posuvu. Tabulku s posuvem na otáčku naleznete od strany 175.

P1.1 ■ 33 I	P1.2 ■ 37 I	P1.3 ■ 38 I	P2.1 ■ 28 I	P2.2 ■ 25 F	P2.3 ■ 22 E	P3.1 ■ 18 F	P3.2 ■ 14 F	P3.3 ■ 12 E	P4.1 ■ 11 F	P4.2 ■ 9 E	P4.3 ■ 7 D	M1.1 ■ 21 E	M1.2 ■ 17 E
M2.1 ■ 18 E	M2.2 ■ 15 E	M3.1 ■ 10 G	M3.2 ■ 9 G	M3.3 ■ 8 G	M4.1 ■ 10 C	K1.1 ■ 30 I	K1.2 ■ 22 E	K1.3 ■ 17 E	K2.1 ■ 25 E	K2.2 ■ 20 E	K2.3 ■ 16 E	K3.1 ■ 22 E	K3.2 ■ 17 E
K3.3 ■ 13 E	K4.1 ■ 20 E	K4.2 ■ 15 E	K4.3 ■ 11 E	K4.4 ■ 10 E	K4.5 ■ 8 E	K5.1 ■ 23 E	K5.2 ■ 17 E	K5.3 ■ 13 E	N1.1 ■ 26 J	N1.2 ■ 20 J	N1.3 ■ 13 I	N2.1 ■ 43 H	N2.2 ■ 39 H
N2.3 ■ 28 H	N3.1 ■ 59 H	N3.2 ■ 35 I	N3.3 ■ 18 F	N4.1 ■ 30 K	N4.2 ■ 28 J	N4.3 ■ 14 H	S1.1 ■ 23 F	S1.2 ■ 13 D	S1.3 ■ 7 B	S2.1 ■ 9 E	S2.2 ■ 6 A	S3.1 ■ 7 E	S3.2 ■ 4 A
S4.1 ■ 5 E	S4.2 ■ 3 A												

DC >= 14mm - bodbroušený vrchol.

Produkt	DC	DC	DC	LCF	OAL	CZC MS
	(inch)	(mm)	(inch)	(mm)	(mm)	
A1303.0	–	3.00	0.1181	33.0	114.0	MK 1
A1301/8	1/8	3.18	0.1252	36.0	117.0	MK 1
A1303.2	–	3.20	0.1260	36.0	117.0	MK 1
A1303.25	–	3.25	0.1280	36.0	117.0	MK 1
A1303.3	–	3.30	0.1299	36.0	117.0	MK 1
A1303.5	–	3.50	0.1378	39.0	120.0	MK 1
A1309/64	9/64	3.57	0.1406	39.0	120.0	MK 1
A1303.75	–	3.75	0.1476	39.0	120.0	MK 1
A1305/32	5/32	3.97	0.1563	43.0	124.0	MK 1
A1304.0	–	4.00	0.1575	43.0	124.0	MK 1
A1304.1	–	4.10	0.1614	43.0	124.0	MK 1
A1304.2	–	4.20	0.1654	43.0	124.0	MK 1
A1304.25	–	4.25	0.1673	43.0	124.0	MK 1
A13011/64	11/64	4.37	0.1719	47.0	128.0	MK 1
A1304.5	–	4.50	0.1772	47.0	128.0	MK 1
A1304.75	–	4.75	0.1870	52.0	128.0	MK 1
A1303/16	3/16	4.76	0.1875	52.0	133.0	MK 1
A1304.8	–	4.80	0.1890	52.0	133.0	MK 1
A1304.9	–	4.90	0.1929	52.0	133.0	MK 1
A1305.0	–	5.00	0.1969	52.0	133.0	MK 1
A1305.1	–	5.10	0.2008	52.0	133.0	MK 1
A13013/64	13/64	5.16	0.2031	52.0	133.0	MK 1
A1305.2	–	5.20	0.2047	52.0	133.0	MK 1



Produkt	DC	DC	DC	LCF	OAL	CZC MS
	(inch)	(mm)	(inch)	(mm)	(mm)	
A1305.25	–	5.25	0.2067	52.0	133.0	MK 1
A1305.4	–	5.40	0.2126	57.0	138.0	MK 1
A1305.5	–	5.50	0.2165	57.0	138.0	MK 1
A1307/32	7/32	5.56	0.2188	57.0	138.0	MK 1
A1305.7	–	5.70	0.2244	57.0	138.0	MK 1
A1305.75	–	5.75	0.2264	57.0	138.0	MK 1
A1305.8	–	5.80	0.2283	57.0	138.0	MK 1
A1305.9	–	5.90	0.2323	57.0	138.0	MK 1
A13015/64	15/64	5.95	0.2344	57.0	138.0	MK 1
A1306.0	–	6.00	0.2362	57.0	138.0	MK 1
A1306.1	–	6.10	0.2402	63.0	144.0	MK 1
A1306.2	–	6.20	0.2441	63.0	144.0	MK 1
A1306.25	–	6.25	0.2461	63.0	144.0	MK 1
A1306.3	–	6.30	0.2480	63.0	144.0	MK 1
A1301/4	1/4	6.35	0.2500	63.0	144.0	MK 1
A1306.4	–	6.40	0.2520	63.0	144.0	MK 1
A1306.5	–	6.50	0.2559	63.0	144.0	MK 1
A1306.6	–	6.60	0.2598	63.0	144.0	MK 1
A1306.7	–	6.70	0.2638	63.0	144.0	MK 1
A13017/64	17/64	6.75	0.2656	69.0	150.0	MK 1
A1306.75	–	6.75	0.2657	69.0	150.0	MK 1
A1306.8	–	6.80	0.2677	69.0	150.0	MK 1
A1306.9	–	6.90	0.2717	69.0	150.0	MK 1
A1307.0	–	7.00	0.2756	69.0	150.0	MK 1
A1309/32	9/32	7.14	0.2813	69.0	150.0	MK 1
A1307.2	–	7.20	0.2835	69.0	150.0	MK 1
A1307.25	–	7.25	0.2854	69.0	150.0	MK 1
A1307.3	–	7.30	0.2874	69.0	150.0	MK 1
A1307.4	–	7.40	0.2913	69.0	150.0	MK 1
A1307.5	–	7.50	0.2953	69.0	150.0	MK 1
A13019/64	19/64	7.54	0.2969	75.0	156.0	MK 1
A1307.7	–	7.70	0.3031	75.0	156.0	MK 1
A1307.75	–	7.75	0.3051	75.0	156.0	MK 1
A1307.8	–	7.80	0.3071	75.0	156.0	MK 1
A1307.9	–	7.90	0.3110	75.0	156.0	MK 1
A1305/16	5/16	7.94	0.3125	75.0	156.0	MK 1
A1308.0	–	8.00	0.3150	75.0	156.0	MK 1
A1308.1	–	8.10	0.3189	75.0	156.0	MK 1
A1308.2	–	8.20	0.3228	75.0	156.0	MK 1
A1308.25	–	8.25	0.3248	75.0	156.0	MK 1
A1308.3	–	8.30	0.3268	75.0	156.0	MK 1
A13021/64	21/64	8.33	0.3281	75.0	156.0	MK 1
A1308.4	–	8.40	0.3307	75.0	156.0	MK 1
A1308.5	–	8.50	0.3346	75.0	156.0	MK 1
A1308.6	–	8.60	0.3386	81.0	162.0	MK 1
A1308.7	–	8.70	0.3425	81.0	162.0	MK 1
A13011/32	11/32	8.73	0.3438	81.0	162.0	MK 1
A1308.75	–	8.75	0.3445	81.0	162.0	MK 1
A1308.8	–	8.80	0.3465	81.0	162.0	MK 1
A1308.9	–	8.90	0.3504	81.0	162.0	MK 1
A1309.0	–	9.00	0.3543	81.0	162.0	MK 1
A1309.1	–	9.10	0.3583	81.0	162.0	MK 1
A13023/64	23/64	9.13	0.3594	81.0	162.0	MK 1
A1309.2	–	9.20	0.3622	81.0	162.0	MK 1
A1309.25	–	9.25	0.3642	81.0	162.0	MK 1
A1309.3	–	9.30	0.3661	81.0	162.0	MK 1
A1309.5	–	9.50	0.3740	81.0	162.0	MK 1
A1303/8	3/8	9.52	0.3750	87.0	168.0	MK 1
A1309.6	–	9.60	0.3780	87.0	168.0	MK 1
A1309.7	–	9.70	0.3819	87.0	168.0	MK 1
A1309.75	–	9.75	0.3839	87.0	168.0	MK 1
A1309.8	–	9.80	0.3858	87.0	168.0	MK 1



Produkt	DC	DC	DC	LCF	OAL	CZC MS
	(inch)	(mm)	(inch)	(mm)	(mm)	
A1309.9	–	9.90	0.3898	87.0	168.0	MK 1
A13025/64	25/64	9.92	0.3906	87.0	168.0	MK 1
A13010.0	–	10.00	0.3937	87.0	168.0	MK 1
A13010.1	–	10.10	0.3976	87.0	168.0	MK 1
A13010.2	–	10.20	0.4016	87.0	168.0	MK 1
A13010.25	–	10.25	0.4035	87.0	168.0	MK 1
A13010.3	–	10.30	0.4055	87.0	168.0	MK 1
A13013/32	13/32	10.32	0.4063	87.0	168.0	MK 1
A13010.5	–	10.50	0.4134	87.0	168.0	MK 1
A13027/64	27/64	10.72	0.4219	94.0	175.0	MK 1
A13010.75	–	10.75	0.4232	94.0	175.0	MK 1
A13010.8	–	10.80	0.4252	94.0	175.0	MK 1
A13010.9	–	10.90	0.4291	94.0	175.0	MK 1
A13011.0	–	11.00	0.4331	94.0	175.0	MK 1
A13011.1	–	11.10	0.4370	94.0	175.0	MK 1
A1307/16	7/16	11.11	0.4375	94.0	175.0	MK 1
A13011.2	–	11.20	0.4409	94.0	175.0	MK 1
A13011.25	–	11.25	0.4429	94.0	175.0	MK 1
A13011.3	–	11.30	0.4449	94.0	175.0	MK 1
A13011.4	–	11.40	0.4488	94.0	175.0	MK 1
A13011.5	–	11.50	0.4528	94.0	175.0	MK 1
A13029/64	29/64	11.51	0.4531	94.0	175.0	MK 1
A13011.6	–	11.60	0.4567	94.0	175.0	MK 1
A13011.7	–	11.70	0.4606	94.0	175.0	MK 1
A13011.75	–	11.75	0.4626	94.0	175.0	MK 1
A13011.8	–	11.80	0.4646	94.0	175.0	MK 1
A13011.9	–	11.90	0.4685	101.0	182.0	MK 1
A13015/32	15/32	11.91	0.4688	101.0	182.0	MK 1
A13012.0	–	12.00	0.4724	101.0	182.0	MK 1
A13012.1	–	12.10	0.4764	101.0	182.0	MK 1
A13012.2	–	12.20	0.4803	101.0	182.0	MK 1
A13012.25	–	12.25	0.4823	101.0	182.0	MK 1
A13031/64	31/64	12.30	0.4844	101.0	182.0	MK 1
A13012.3	–	12.30	0.4843	101.0	182.0	MK 1
A13012.4	–	12.40	0.4882	101.0	182.0	MK 1
A13012.5	–	12.50	0.4921	101.0	182.0	MK 1
A13012.6	–	12.60	0.4961	101.0	182.0	MK 1
A13012.7	–	12.70	0.5000	101.0	182.0	MK 1
A1301/2	1/2	12.70	0.5000	101.0	182.0	MK 1
A13012.75	–	12.75	0.5020	101.0	182.0	MK 1
A13012.8	–	12.80	0.5039	101.0	182.0	MK 1
A13012.9	–	12.90	0.5079	101.0	182.0	MK 1
A13013.0	–	13.00	0.5118	101.0	182.0	MK 1
A13033/64	33/64	13.10	0.5156	101.0	182.0	MK 1
A13013.2	–	13.20	0.5197	101.0	182.0	MK 1
A13013.25	–	13.25	0.5217	108.0	189.0	MK 1
A13017/32	17/32	13.49	0.5313	108.0	189.0	MK 1
A13013.5	–	13.50	0.5315	108.0	189.0	MK 1
A13013.6	–	13.60	0.5354	108.0	189.0	MK 1
A13013.7	–	13.70	0.5394	108.0	189.0	MK 1
A13013.75	–	13.75	0.5413	108.0	189.0	MK 1
A13013.8	–	13.80	0.5433	108.0	189.0	MK 1
A13035/64	35/64	13.89	0.5469	108.0	189.0	MK 1
A13013.9	–	13.90	0.5472	108.0	189.0	MK 1
A13014.0	–	14.00	0.5512	108.0	189.0	MK 1
A13014.1	–	14.10	0.5551	114.0	212.0	MK 2
A13014.2	–	14.20	0.5591	114.0	212.0	MK 2
A13014.25	–	14.25	0.5610	114.0	212.0	MK 2
A1309/16	9/16	14.29	0.5625	114.0	212.0	MK 2
A13014.3	–	14.30	0.5630	114.0	212.0	MK 2
A13014.4	–	14.40	0.5669	114.0	212.0	MK 2
A13014.5	–	14.50	0.5709	114.0	212.0	MK 2



Produkt	DC	DC	DC	LCF	OAL	CZC MS
	(inch)	(mm)	(inch)	(mm)	(mm)	
A13014.6	–	14.60	0.5748	114.0	212.0	MK 2
A13037/64	37/64	14.68	0.5781	114.0	212.0	MK 2
A13014.7	–	14.70	0.5787	114.0	212.0	MK 2
A13014.75	–	14.75	0.5807	114.0	212.0	MK 2
A13014.8	–	14.80	0.5827	114.0	212.0	MK 2
A13014.9	–	14.90	0.5866	114.0	212.0	MK 2
A13015.0	–	15.00	0.5906	114.0	212.0	MK 2
A13019/32	19/32	15.08	0.5938	120.0	218.0	MK 2
A13015.1	–	15.10	0.5945	120.0	218.0	MK 2
A13015.2	–	15.20	0.5984	120.0	218.0	MK 2
A13015.25	–	15.25	0.6004	120.0	218.0	MK 2
A13039/64	39/64	15.48	0.6094	120.0	218.0	MK 2
A13015.5	–	15.50	0.6102	120.0	218.0	MK 2
A13015.7	–	15.70	0.6181	120.0	218.0	MK 2
A13015.75	–	15.75	0.6201	120.0	218.0	MK 2
A13015.8	–	15.80	0.6220	120.0	218.0	MK 2
A1305/8	5/8	15.88	0.6250	120.0	218.0	MK 2
A13015.9	–	15.90	0.6260	120.0	218.0	MK 2
A13016.0	–	16.00	0.6299	120.0	218.0	MK 2
A13016.1	–	16.10	0.6339	125.0	223.0	MK 2
A13016.2	–	16.20	0.6378	125.0	223.0	MK 2
A13016.25	–	16.25	0.6398	125.0	223.0	MK 2
A13041/64	41/64	16.27	0.6406	125.0	223.0	MK 2
A13016.5	–	16.50	0.6496	125.0	223.0	MK 2
A13021/32	21/32	16.67	0.6563	125.0	223.0	MK 2
A13016.75	–	16.75	0.6594	125.0	223.0	MK 2
A13017.0	–	17.00	0.6693	125.0	223.0	MK 2
A13043/64	43/64	17.07	0.6719	130.0	228.0	MK 2
A13017.25	–	17.25	0.6791	130.0	228.0	MK 2
A13011/16	11/16	17.46	0.6875	130.0	228.0	MK 2
A13017.5	–	17.50	0.6890	130.0	228.0	MK 2
A13017.75	–	17.75	0.6988	130.0	228.0	MK 2
A13045/64	45/64	17.86	0.7031	130.0	228.0	MK 2
A13018.0	–	18.00	0.7087	130.0	228.0	MK 2
A13018.25	–	18.25	0.7185	135.0	233.0	MK 2
A13023/32	23/32	18.26	0.7188	135.0	233.0	MK 2
A13018.5	–	18.50	0.7283	135.0	233.0	MK 2
A13047/64	47/64	18.65	0.7344	135.0	233.0	MK 2
A13018.75	–	18.75	0.7382	135.0	233.0	MK 2
A13019.0	–	19.00	0.7480	135.0	233.0	MK 2
A1303/4	3/4	19.05	0.7500	140.0	238.0	MK 2
A13019.25	–	19.25	0.7579	140.0	238.0	MK 2
A13049/64	49/64	19.45	0.7656	140.0	238.0	MK 2
A13019.5	–	19.50	0.7677	140.0	238.0	MK 2
A13019.75	–	19.75	0.7776	140.0	238.0	MK 2
A13025/32	25/32	19.84	0.7813	140.0	238.0	MK 2
A13020.0	–	20.00	0.7874	140.0	238.0	MK 2
A13051/64	51/64	20.24	0.7969	145.0	243.0	MK 2
A13020.25	–	20.25	0.7972	145.0	243.0	MK 2
A13020.4	–	20.40	0.8031	145.0	243.0	MK 2
A13020.5	–	20.50	0.8071	145.0	243.0	MK 2
A13013/16	13/16	20.64	0.8125	145.0	243.0	MK 2
A13020.75	–	20.75	0.8169	145.0	243.0	MK 2
A13021.0	–	21.00	0.8268	145.0	243.0	MK 2
A13053/64	53/64	21.03	0.8281	145.0	243.0	MK 2
A13021.25	–	21.25	0.8366	150.0	248.0	MK 2
A13027/32	27/32	21.43	0.8437	150.0	248.0	MK 2
A13021.5	–	21.50	0.8465	150.0	248.0	MK 2
A13021.75	–	21.75	0.8563	150.0	248.0	MK 2
A13055/64	55/64	21.83	0.8594	150.0	248.0	MK 2
A13022.0	–	22.00	0.8661	150.0	248.0	MK 2
A1307/8	7/8	22.22	0.8750	150.0	248.0	MK 2



Produkt	DC	DC	DC	LCF	OAL	CZC MS
	(inch)	(mm)	(inch)	(mm)	(mm)	
A13022.25	–	22.25	0.8760	150.0	248.0	MK 2
A13022.5	–	22.50	0.8858	155.0	253.0	MK 2
A13057/64	57/64	22.62	0.8906	155.0	253.0	MK 2
A13022.75	–	22.75	0.8957	155.0	253.0	MK 2
A13023.0	–	23.00	0.9055	155.0	253.0	MK 2
A13029/32	29/32	23.02	0.9063	155.0	253.0	MK 2
A13023.25	–	23.25	0.9154	155.0	276.0	MK 3
A13059/64	59/64	23.42	0.9219	155.0	276.0	MK 3
A13023.5	–	23.50	0.9252	155.0	276.0	MK 3
A13023.75	–	23.75	0.9350	160.0	281.0	MK 3
A13015/16	15/16	23.81	0.9375	160.0	281.0	MK 3
A13024.0	–	24.00	0.9449	160.0	281.0	MK 3
A13061/64	61/64	24.21	0.9531	160.0	281.0	MK 3
A13024.25	–	24.25	0.9547	160.0	281.0	MK 3
A13024.5	–	24.50	0.9646	160.0	281.0	MK 3
A13031/32	31/32	24.61	0.9688	160.0	281.0	MK 3
A13024.75	–	24.75	0.9744	160.0	281.0	MK 3
A13025.0	–	25.00	0.9843	160.0	281.0	MK 3
A13063/64	63/64	25.00	0.9844	160.0	286.0	MK 3
A13025.25	–	25.25	0.9941	165.0	286.0	MK 3
A1301	1"	25.40	1.0000	165.0	286.0	MK 3
A13025.5	–	25.50	1.0039	165.0	286.0	MK 3
A13025.75	–	25.75	1.0138	165.0	286.0	MK 3
A13026.0	–	26.00	1.0236	165.0	286.0	MK 3
A13026.25	–	26.25	1.0335	165.0	286.0	MK 3
A13026.5	–	26.50	1.0433	165.0	286.0	MK 3
A13026.75	–	26.75	1.0531	170.0	291.0	MK 3
A1301.1/16	1.1/16	26.99	1.0625	170.0	291.0	MK 3
A13027.0	–	27.00	1.0630	170.0	291.0	MK 3
A13027.25	–	27.25	1.0728	170.0	291.0	MK 3
A13027.5	–	27.50	1.0827	170.0	291.0	MK 3
A13027.75	–	27.75	1.0925	170.0	291.0	MK 3
A13028.0	–	28.00	1.1024	170.0	291.0	MK 3
A13028.25	–	28.25	1.1122	175.0	296.0	MK 3
A13028.5	–	28.50	1.1220	175.0	296.0	MK 3
A1301.1/8	1.1/8	28.58	1.1250	175.0	296.0	MK 3
A13028.75	–	28.75	1.1319	175.0	296.0	MK 3
A13029.0	–	29.00	1.1417	175.0	296.0	MK 3
A13029.25	–	29.25	1.1516	175.0	296.0	MK 3
A1301.5/32	1.5/32	29.37	1.1563	175.0	296.0	MK 3
A13029.5	–	29.50	1.1614	175.0	296.0	MK 3
A13029.75	–	29.75	1.1713	175.0	296.0	MK 3
A13030.0	–	30.00	1.1811	175.0	296.0	MK 3
A1301.3/16	1.3/16	30.16	1.1875	180.0	301.0	MK 3
A13030.25	–	30.25	1.1909	180.0	301.0	MK 3
A13030.5	–	30.50	1.2008	180.0	301.0	MK 3
A13030.75	–	30.75	1.2106	180.0	301.0	MK 3
A1301.7/32	1.7/32	30.96	1.2188	180.0	301.0	MK 3
A13031.0	–	31.00	1.2205	180.0	301.0	MK 3
A13031.25	–	31.25	1.2303	180.0	301.0	MK 3
A13031.5	–	31.50	1.2402	180.0	301.0	MK 3
A13031.75	–	31.75	1.2500	185.0	306.0	MK 3
A1301.1/4	1.1/4	31.75	1.2500	185.0	306.0	MK 3
A13032.0	–	32.00	1.2598	185.0	334.0	MK 4
A13032.5	–	32.50	1.2795	185.0	334.0	MK 4
A1301.9/32	1.9/32	32.54	1.2813	185.0	334.0	MK 4
A13033.0	–	33.00	1.2992	185.0	334.0	MK 4
A1301.5/16	1.5/16	33.34	1.3125	185.0	334.0	MK 4
A13033.5	–	33.50	1.3189	185.0	334.0	MK 4
A13034.0	–	34.00	1.3386	190.0	339.0	MK 4
A1301.11/32	1.11/32	34.13	1.3438	190.0	339.0	MK 4
A13034.5	–	34.50	1.3583	190.0	339.0	MK 4



Produkt	DC	DC	DC	LCF	OAL	CZC MS
	(inch)	(mm)	(inch)	(mm)	(mm)	
A1301.3/8	1.3/8	34.93	1.3750	190.0	339.0	MK 4
A13035.0	–	35.00	1.3780	190.0	339.0	MK 4
A13035.5	–	35.50	1.3976	190.0	339.0	MK 4
A1301.13/32	1.13/32	35.72	1.4063	195.0	344.0	MK 4
A13036.0	–	36.00	1.4173	195.0	344.0	MK 4
A13036.5	–	36.50	1.4370	195.0	344.0	MK 4
A1301.7/16	1.7/16	36.51	1.4375	195.0	344.0	MK 4
A13037.0	–	37.00	1.4567	195.0	344.0	MK 4
A13037.5	–	37.50	1.4764	195.0	344.0	MK 4
A13038.0	–	38.00	1.4961	200.0	349.0	MK 4
A1301.1/2	1.1/2	38.10	1.5000	200.0	349.0	MK 4
A13038.5	–	38.50	1.5157	200.0	349.0	MK 4
A13039.0	–	39.00	1.5354	200.0	349.0	MK 4
A13039.5	–	39.50	1.5551	200.0	349.0	MK 4
A1301.9/16	1.9/16	39.69	1.5625	200.0	349.0	MK 4
A13040.0	–	40.00	1.5748	200.0	349.0	MK 4
A13040.5	–	40.50	1.5945	205.0	354.0	MK 4
A13041.0	–	41.00	1.6142	205.0	354.0	MK 4
A1301.5/8	1.5/8	41.28	1.6250	205.0	354.0	MK 4
A13041.5	–	41.50	1.6339	205.0	354.0	MK 4
A13042.0	–	42.00	1.6535	205.0	354.0	MK 4
A13042.5	–	42.50	1.6732	205.0	354.0	MK 4
A1301.11/16	1.11/16	42.86	1.6875	210.0	359.0	MK 4
A13043.0	–	43.00	1.6929	210.0	359.0	MK 4
A13043.5	–	43.50	1.7126	210.0	359.0	MK 4
A13044.0	–	44.00	1.7323	210.0	359.0	MK 4
A1301.3/4	1.3/4	44.45	1.7500	210.0	359.0	MK 4
A13044.5	–	44.50	1.7520	210.0	359.0	MK 4
A13045.0	–	45.00	1.7717	210.0	359.0	MK 4
A13045.5	–	45.50	1.7913	215.0	364.0	MK 4
A13046.0	–	46.00	1.8110	215.0	364.0	MK 4
A13046.5	–	46.50	1.8307	215.0	364.0	MK 4
A13047.0	–	47.00	1.8504	215.0	364.0	MK 4
A13047.5	–	47.50	1.8701	215.0	364.0	MK 4
A13048.0	–	48.00	1.8898	220.0	369.0	MK 4
A13048.5	–	48.50	1.9094	220.0	369.0	MK 4
A13049.0	–	49.00	1.9291	220.0	369.0	MK 4
A13049.5	–	49.50	1.9488	220.0	369.0	MK 4
A13050.0	–	50.00	1.9685	220.0	369.0	MK 4
A1302	2"	50.80	2.0000	225.0	374.0	MK 4



A530



HSS Vrták s kuželovou stopkou, Povlak TiN

Vrcholový úhel 118° s konvenční geometrií řezné hrany usnadňuje přebrušování. Robustní konstrukce vrtáku zvyšuje využití na klasických obráběcích strojích. Vhodný pro širokou oblast obráběných materiálů. Povlak TiN zvyšuje výkon a prodlužuje životnost.

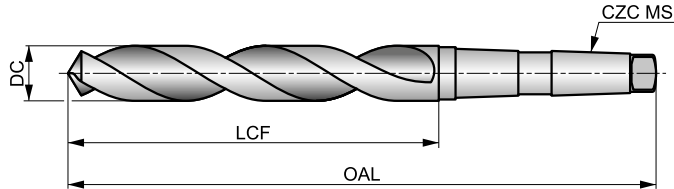

HSS	DIN 345	4xD
118°	TiN	
λ 20-35°	R	DC h8

Skupiny obráběných materiálů, startovní řezná rychlost (Vc m/min) a kód posuvu. Tabulku s posuvem na otáčku naleznete od strany 175.

P1.1 ■ 40 I	P1.2 ■ 45 I	P1.3 ■ 46 I	P2.1 ■ 34 I	P2.2 ■ 30 F	P2.3 ■ 27 E	P3.1 ■ 29 F	P3.2 ■ 24 F	P3.3 ■ 20 E	P4.1 ■ 18 F	P4.2 ■ 15 E	P4.3 ■ 12 D	M1.1 ■ 33 E	M1.2 ■ 28 E
M2.1 ■ 29 E	M2.2 ■ 24 E	M3.1 ■ 15 G	M3.2 ■ 13 G	M3.3 ■ 12 G	M4.1 ■ 20 C	K1.1 ■ 36 I	K1.2 ■ 27 E	K1.3 ■ 20 E	K2.1 ■ 33 E	K2.2 ■ 27 E	K2.3 ■ 22 E	K3.1 ■ 29 E	K3.2 ■ 22 E
K3.3 ■ 18 E	K4.1 ■ 27 E	K4.2 ■ 21 E	K4.3 ■ 15 E	K4.4 ■ 13 E	K4.5 ■ 11 E	K5.1 ■ 31 E	K5.2 ■ 23 E	K5.3 ■ 18 E	N1.1 ■ 55 I	N1.2 ■ 41 I	N1.3 ■ 28 I	N2.1 ■ 54 G	N2.2 ■ 48 G
N2.3 ■ 35 G	N3.1 ■ 93 G	N3.2 ■ 55 I	N3.3 ■ 28 G	N4.1 ■ 50 J	N4.2 ■ 50 H	N4.3 ■ 35 F	S1.1 ■ 32 F	S1.2 ■ 18 D	S1.3 ■ 13 B	S2.1 ■ 8 E	S2.2 ■ 4 A	S3.1 ■ 6 E	S3.2 ■ 3 A
S4.1 ■ 5 E	S4.2 ■ 2 A												

DC >= 14mm - bodbroušený vrchol.

Produkt	DC		LCF	OAL	CZC MS
	(mm)	(inch)			
A5308.5	8.50	0.3346	75.0	156.0	MK 1
A5309.0	9.00	0.3543	81.0	162.0	MK 1
A53010.0	10.00	0.3937	87.0	168.0	MK 1
A53010.2	10.20	0.4016	87.0	168.0	MK 1
A53010.5	10.50	0.4134	87.0	168.0	MK 1
A53011.0	11.00	0.4331	94.0	175.0	MK 1
A53011.5	11.50	0.4528	94.0	175.0	MK 1
A53011.75	11.75	0.4626	94.0	175.0	MK 1
A53012.0	12.00	0.4724	101.0	182.0	MK 1
A53012.5	12.50	0.4921	101.0	182.0	MK 1
A53013.0	13.00	0.5118	101.0	182.0	MK 1
A53013.5	13.50	0.5315	108.0	189.0	MK 1
A53014.0	14.00	0.5512	108.0	189.0	MK 1
A53014.5	14.50	0.5709	114.0	212.0	MK 2
A53015.0	15.00	0.5906	114.0	212.0	MK 2
A53015.25	15.25	0.6004	120.0	218.0	MK 2
A53015.5	15.50	0.6102	120.0	218.0	MK 2
A53016.0	16.00	0.6299	120.0	218.0	MK 2
A53016.5	16.50	0.6496	125.0	223.0	MK 2
A53017.0	17.00	0.6693	125.0	223.0	MK 2
A53017.5	17.50	0.6890	130.0	228.0	MK 2
A53018.0	18.00	0.7087	130.0	228.0	MK 2
A53018.5	18.50	0.7283	135.0	233.0	MK 2
A53019.0	19.00	0.7480	135.0	233.0	MK 2
A53019.5	19.50	0.7677	140.0	238.0	MK 2
A53020.0	20.00	0.7874	140.0	238.0	MK 2

Produkt	DC		LCF	OAL	CZC MS
	(mm)	(inch)			
A53020.5	20.50	0.8071	145.0	243.0	MK 2
A53021.0	21.00	0.8268	145.0	243.0	MK 2
A53021.5	21.50	0.8465	150.0	248.0	MK 2
A53022.0	22.00	0.8661	150.0	248.0	MK 2
A53022.5	22.50	0.8858	155.0	253.0	MK 2
A53023.0	23.00	0.9055	155.0	253.0	MK 2
A53023.5	23.50	0.9252	155.0	276.0	MK 3
A53024.0	24.00	0.9449	160.0	281.0	MK 3
A53024.5	24.50	0.9646	160.0	281.0	MK 3
A53025.0	25.00	0.9843	160.0	281.0	MK 3
A53025.5	25.50	1.0039	165.0	286.0	MK 3
A53026.0	26.00	1.0236	165.0	286.0	MK 3
A53026.5	26.50	1.0433	165.0	286.0	MK 3
A53027.0	27.00	1.0630	170.0	291.0	MK 3
A53027.5	27.50	1.0827	170.0	291.0	MK 3
A53028.0	28.00	1.1024	170.0	291.0	MK 3
A53028.5	28.50	1.1220	175.0	296.0	MK 3
A53029.0	29.00	1.1417	175.0	296.0	MK 3
A53029.5	29.50	1.1614	175.0	296.0	MK 3
A53030.0	30.00	1.1811	175.0	296.0	MK 3
A53031.0	31.00	1.2205	180.0	301.0	MK 3
A53032.0	32.00	1.2598	185.0	334.0	MK 4
A53033.0	33.00	1.2992	185.0	334.0	MK 4
A53035.0	35.00	1.3780	190.0	339.0	MK 4
A53040.0	40.00	1.5748	200.0	349.0	MK 4



A730



HSS-E (8 % kobaltu) Navrtávák, Povrchová úprava Bronz

Doporučen pro těžké operace. Vrták s vrcholovým úhlem 118° a snadným přebrušováním. Bronzový povrch je tenká zoxidovaná vrstva použitá na HSS-E vrtácích s obsahem kobaltu. Vhodný pro širokou oblast obráběných materiálů.

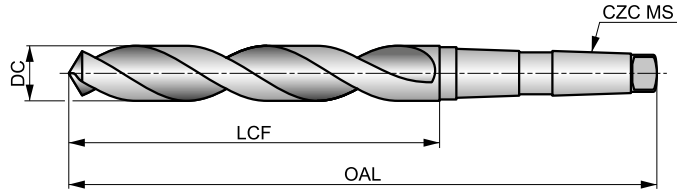

HSS-E	DIN 345	4xD
118°	Bronze	
λ 20-35°	R	DC h8

Skupiny obráběných materiálů, startovní řezná rychlost (Vc m/min) a kód posuvu. Tabulku s posuvem na otáčku naleznete od strany 175.

P1.1 ■ 36 H	P1.2 ■ 40 H	P1.3 ■ 41 H	P2.1 ■ 31 H	P2.2 ■ 27 G	P2.3 ■ 24 E	P3.1 ■ 25 F	P3.2 ■ 20 F	P3.3 ■ 17 E	P4.1 ■ 15 F	P4.2 ■ 13 E	P4.3 ■ 10 D	M1.1 ■ 33 E	M1.2 ■ 28 E
M2.1 ■ 29 E	M2.2 ■ 24 E	M3.1 ■ 13 G	M3.2 ■ 11 G	M3.3 ■ 10 G	M4.1 ■ 17 C	K1.1 ■ 35 J	K1.2 ■ 26 G	K1.3 ■ 19 G	K2.1 ■ 27 E	K2.2 ■ 22 E	K2.3 ■ 18 E	K3.1 ■ 24 E	K3.2 ■ 18 E
K3.3 ■ 15 E	K4.1 ■ 22 E	K4.2 ■ 17 E	K4.3 ■ 12 E	K4.4 ■ 11 E	K4.5 ■ 9 E	K5.1 ■ 25 E	K5.2 ■ 19 E	K5.3 ■ 15 E	N1.1 ■ 33 J	N1.2 ■ 25 J	N1.3 ■ 17 I	N2.1 ■ 46 H	N2.2 ■ 42 H
N2.3 ■ 30 H	N3.1 ■ 68 H	N3.2 ■ 40 J	N3.3 ■ 20 L	N4.1 ■ 35 K	N4.2 ■ 28 J	N4.3 ■ 20 H	S1.1 ■ 28 G	S1.2 ■ 20 D	S1.3 ■ 11 C	S2.1 ■ 9 E	S2.2 ■ 8 B	S3.1 ■ 7 E	S3.2 ■ 6 B
S4.1 ■ 5 E	S4.2 ■ 5 B												

DC >= 14mm - bodbrušený vrchol.

Produkt	DC (mm)	DC (inch)	LCF (mm)	OAL (mm)	CZC MS	Produkt	DC (mm)	DC (inch)	LCF (mm)	OAL (mm)	CZC MS
A73010.0	10.00	0.3937	87.0	168.0	MK 1	A73016.25	16.25	0.6398	120.0	218.0	MK 2
A73010.2	10.20	0.4016	87.0	168.0	MK 1	A73016.5	16.50	0.6496	125.0	223.0	MK 2
A73010.5	10.50	0.4134	87.0	168.0	MK 1	A73017.0	17.00	0.6693	125.0	223.0	MK 2
A73010.8	10.80	0.4252	94.0	175.0	MK 1	A73017.25	17.25	0.6791	130.0	228.0	MK 2
A73011.0	11.00	0.4331	94.0	175.0	MK 1	A73017.5	17.50	0.6890	130.0	228.0	MK 2
A73011.5	11.50	0.4528	94.0	175.0	MK 1	A73017.75	17.75	0.6988	130.0	228.0	MK 2
A73011.8	11.80	0.4646	94.0	175.0	MK 1	A73018.0	18.00	0.7087	130.0	228.0	MK 2
A73012.0	12.00	0.4724	101.0	182.0	MK 1	A73018.25	18.25	0.7185	135.0	233.0	MK 2
A73012.2	12.20	0.4803	101.0	182.0	MK 1	A73018.5	18.50	0.7283	135.0	233.0	MK 2
A73012.5	12.50	0.4921	101.0	182.0	MK 1	A73018.75	18.75	0.7382	135.0	233.0	MK 2
A73012.8	12.80	0.5039	101.0	182.0	MK 1	A73019.0	19.00	0.7480	135.0	233.0	MK 2
A73013.0	13.00	0.5118	101.0	182.0	MK 1	A73019.25	19.25	0.7579	140.0	238.0	MK 2
A73013.5	13.50	0.5315	108.0	189.0	MK 1	A73019.5	19.50	0.7677	140.0	238.0	MK 2
A73013.8	13.80	0.5433	108.0	189.0	MK 1	A73019.75	19.75	0.7776	140.0	238.0	MK 2
A73014.0	14.00	0.5512	108.0	189.0	MK 1	A73020.0	20.00	0.7874	140.0	238.0	MK 2
A73014.25	14.25	0.5610	114.0	212.0	MK 2	A73020.25	20.25	0.7972	145.0	243.0	MK 2
A73014.5	14.50	0.5709	114.0	212.0	MK 2	A73020.5	20.50	0.8071	145.0	243.0	MK 2
A73014.75	14.75	0.5807	114.0	212.0	MK 2	A73020.75	20.75	0.8169	145.0	243.0	MK 2
A73015.0	15.00	0.5906	114.0	212.0	MK 2	A73021.0	21.00	0.8268	145.0	243.0	MK 2
A73015.25	15.25	0.6004	120.0	218.0	MK 2	A73021.5	21.50	0.8465	150.0	248.0	MK 2
A73015.5	15.50	0.6102	120.0	218.0	MK 2	A73022.0	22.00	0.8661	150.0	248.0	MK 2
A73015.75	15.75	0.6201	120.0	218.0	MK 2	A73022.5	22.50	0.8858	155.0	253.0	MK 2
A73016.0	16.00	0.6299	120.0	218.0	MK 2	A73023.0	23.00	0.9055	155.0	253.0	MK 2



Produkt	DC	DC	LCF	OAL	CZC MS
	(mm)	(inch)	(mm)	(mm)	
A73023.5	23.50	0.9252	155.0	276.0	MK 3
A73024.0	24.00	0.9449	160.0	281.0	MK 3
A73024.5	24.50	0.9646	160.0	281.0	MK 3
A73025.0	25.00	0.9843	160.0	281.0	MK 3
A73025.5	25.50	1.0039	165.0	286.0	MK 3
A73026.0	26.00	1.0236	165.0	286.0	MK 3
A73026.5	26.50	1.0433	165.0	286.0	MK 3
A73027.0	27.00	1.0630	170.0	291.0	MK 3

Produkt	DC	DC	LCF	OAL	CZC MS
	(mm)	(inch)	(mm)	(mm)	
A73027.5	27.50	1.0827	170.0	291.0	MK 3
A73028.0	28.00	1.1024	170.0	291.0	MK 3
A73028.5	28.50	1.1220	175.0	296.0	MK 3
A73029.0	29.00	1.1417	175.0	296.0	MK 3
A73030.0	30.00	1.1811	175.0	296.0	MK 3
A73031.0	31.00	1.2205	180.0	301.0	MK 3
A73032.0	32.00	1.2598	185.0	334.0	MK 4



A166



HSS Vrták s naletovanou karbidovou špičkou, Kuželovou stopkou, Parní temperace povrchu

Napájená karbidová špička dodává vysoký výkon nástroje, pevné a méně křehké tělo vrtáku je zároveň ekonomickým řešením. Vrcholový úhel 118° a konstrukce se 4 fazetkami napomáhá vystředění a usnadňuje přebrušování. Ekonomická volba zejména pro vrtání litin.

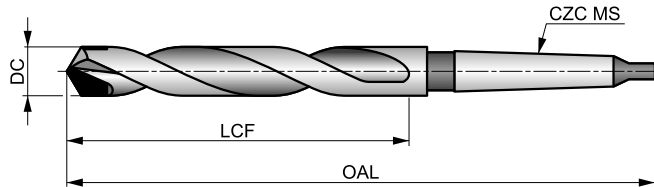

HSS HM	DIN 345	4×D
118°	Bright ST	
λ 20-35°	R	DC h8

Skupiny obráběných materiálů, startovní řezná rychlost (Vc m/min) a kód posuvu. Tabulku s posuvem na otáčku naleznete od strany 175.

P1.1 ▣73 E	P1.2 ▣82 E	P1.3 ▣85 E	P2.1 ▣63 E	P2.2 ▣55 D	P2.3 ▣49 C	P3.1 ▣59 D	P3.2 ▣47 D	P3.3 ▣40 C	P4.1 ▣35 D	P4.2 ▣30 C	P4.3 ▣24 A	M1.1 ▣55 B	M1.2 ▣46 B
M2.1 ▣49 B	M2.2 ▣40 B	M3.1 ▣41 C	M3.2 ▣35 C	M3.3 ▣32 C	M4.1 ▣35 A	K1.1 ▣50 C	K1.2 ▣37 C	K1.3 ▣28 C	K2.1 ▣43 C	K2.2 ▣35 C	K2.3 ▣28 A	K3.1 ▣38 C	K3.2 ▣29 C
K3.3 ▣24 A	K4.1 ▣35 C	K4.2 ▣27 C	K4.3 ▣20 A	K4.4 ▣17 A	K4.5 ▣14 A	K5.1 ▣40 C	K5.2 ▣30 C	K5.3 ▣23 A	N1.1 ▣50 I	N1.2 ▣38 I	N1.3 ▣25 H	N2.1 ▣62 G	N2.2 ▣55 G
N2.3 ▣40 G	N3.1 ▣127 C	N3.2 ▣75 G	N3.3 ▣38 D	N4.2 ▣60 E	S1.1 ▣35 A	S1.2 ▣35 A	S1.3 ▣25 A	S2.1 ▣33 A	S2.2 ▣28 A	S3.1 ▣25 A	S3.2 ▣20 A	S4.1 ▣20 A	S4.2 ▣16 A

Produkt	DC	DC	LCF	OAL	CZC MS	Produkt	DC	DC	LCF	OAL	CZC MS
	(mm)	(inch)					(mm)	(mm)			
A16610.0	10.00	0.3937	87.0	168.0	MK 1	A16620.0	20.00	0.7874	140.0	238.0	MK 2
A16610.5	10.50	0.4134	87.0	168.0	MK 1	A16621.0	21.00	0.8268	145.0	243.0	MK 2
A16611.0	11.00	0.4331	94.0	175.0	MK 1	A16622.0	22.00	0.8661	150.0	248.0	MK 2
A16611.5	11.50	0.4528	94.0	175.0	MK 1	A16622.5	22.50	0.8858	155.0	253.0	MK 2
A16612.0	12.00	0.4724	101.0	182.0	MK 1	A16623.0	23.00	0.9055	155.0	253.0	MK 2
A16613.0	13.00	0.5118	101.0	182.0	MK 1	A16624.0	24.00	0.9449	160.0	281.0	MK 3
A16613.5	13.50	0.5315	108.0	189.0	MK 1	A16625.0	25.00	0.9843	160.0	281.0	MK 3
A16614.0	14.00	0.5512	108.0	189.0	MK 1	A16626.0	26.00	1.0236	165.0	286.0	MK 3
A16615.0	15.00	0.5906	114.0	212.0	MK 2	A16627.0	27.00	1.0630	170.0	291.0	MK 3
A16616.0	16.00	0.6299	120.0	218.0	MK 2	A16628.0	28.00	1.1024	170.0	291.0	MK 3
A16617.0	17.00	0.6693	125.0	223.0	MK 2	A16629.0	29.00	1.1417	175.0	296.0	MK 3
A16617.5	17.50	0.6890	130.0	228.0	MK 2	A16630.0	30.00	1.1811	175.0	296.0	MK 3
A16618.0	18.00	0.7087	130.0	228.0	MK 2	A16632.0	32.00	1.2598	185.0	334.0	MK 4
A16619.0	19.00	0.7480	135.0	233.0	MK 2	A16633.0	33.00	1.2992	185.0	334.0	MK 4



A350



HSS Dlouhý vrták s kuželovou stopkou, Parní temperace povrchu

Doporučen pro vrtání hlubokých otvorů nebo vrtání v těžko dostupných místech. Vrták s vrcholovým úhlem 118° a snadným přebušováním. Parní temperace povrchu zadržuje řeznou kapalinu na povrchu a brání nalepování třísek. Vhodný pro širokou oblast obráběných materiálů.

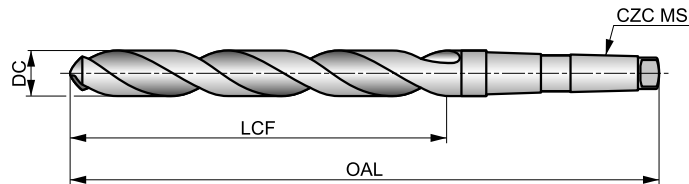

HSS	DIN 341	6xD
118°	ST	
λ 20-35°	R	DC h8

Skupiny obráběných materiálů, startovní řezná rychlost (Vc m/min) a kód posuvu. Tabulku s posuvem na otáčku naleznete od strany 175.

P1.1 ■ 27 I	P1.2 ■ 30 I	P1.3 ■ 31 I	P2.1 ■ 23 I	P2.2 ■ 20 G	P2.3 ■ 18 E	P3.1 ■ 15 F	P3.2 ■ 12 F	P3.3 ■ 10 E	P4.1 ■ 9 F	P4.2 ■ 7 E	P4.3 ■ 6 D	M1.1 ■ 18 E	M1.2 ■ 15 E
M2.1 ■ 16 E	M2.2 ■ 13 E	M3.1 ■ 5 G	M3.2 ■ 4 G	M3.3 ■ 4 G	M4.1 ■ 8 C	K1.1 ■ 26 I	K1.2 ■ 19 F	K1.3 ■ 14 F	K2.1 ■ 22 E	K2.2 ■ 18 E	K2.3 ■ 14 E	K3.1 ■ 20 E	K3.2 ■ 15 E
K3.3 ■ 12 E	K4.1 ■ 18 E	K4.2 ■ 14 E	K4.3 ■ 10 E	K4.4 ■ 9 E	K4.5 ■ 7 E	K5.1 ■ 21 E	K5.2 ■ 15 E	K5.3 ■ 12 E	N1.1 ■ 33 J	N1.2 ■ 25 J	N1.3 ■ 17 I	N2.1 ■ 42 H	N2.2 ■ 37 H
N2.3 ■ 27 H	N3.1 ■ 59 H	N3.2 ■ 35 I	N3.3 ■ 18 F	N4.1 ■ 35 L	N4.2 ■ 26 J	N4.3 ■ 12 H	S1.1 ■ 16 F	S1.2 ■ 9 D	S1.3 ■ 5 B	S2.1 ■ 5 E	S2.2 ■ 4 A	S3.1 ■ 4 E	S3.2 ■ 3 A
S4.1 ■ 3 E	S4.2 ■ 2 A												

Produkt	DC (mm)	DC (inch)	LCF (mm)	OAL (mm)	CZC MS
A3505.0	5.00	0.1969	74.0	155.0	MK 1
A3505.5	5.50	0.2165	80.0	161.0	MK 1
A3506.0	6.00	0.2362	80.0	161.0	MK 1
A3506.7	6.70	0.2638	86.0	167.0	MK 1
A3506.8	6.80	0.2677	93.0	174.0	MK 1
A3507.0	7.00	0.2756	93.0	174.0	MK 1
A3507.5	7.50	0.2953	93.0	174.0	MK 1
A3508.0	8.00	0.3150	100.0	181.0	MK 1
A3508.4	8.40	0.3307	100.0	181.0	MK 1
A3508.5	8.50	0.3346	100.0	181.0	MK 1
A3508.75	8.75	0.3445	107.0	188.0	MK 1
A3509.0	9.00	0.3543	107.0	188.0	MK 1
A3509.5	9.50	0.3740	107.0	188.0	MK 1
A3509.8	9.80	0.3858	116.0	197.0	MK 1
A35010.0	10.00	0.3937	116.0	197.0	MK 1
A35010.2	10.20	0.4016	116.0	197.0	MK 1
A35010.5	10.50	0.4134	116.0	197.0	MK 1
A35010.7	10.70	0.4213	125.0	206.0	MK 1
A35011.0	11.00	0.4331	125.0	206.0	MK 1
A35011.5	11.50	0.4528	125.0	206.0	MK 1
A35011.75	11.75	0.4626	125.0	206.0	MK 1
A35011.8	11.80	0.4646	125.0	206.0	MK 1
A35012.0	12.00	0.4724	134.0	215.0	MK 1
A35012.5	12.50	0.4921	134.0	215.0	MK 1

Produkt	DC (mm)	DC (inch)	LCF (mm)	OAL (mm)	CZC MS
A35013.0	13.00	0.5118	134.0	215.0	MK 1
A35013.5	13.50	0.5315	142.0	223.0	MK 1
A35014.0	14.00	0.5512	142.0	223.0	MK 1
A35014.25	14.25	0.5610	147.0	245.0	MK 2
A35014.5	14.50	0.5709	147.0	245.0	MK 2
A35014.75	14.75	0.5807	147.0	245.0	MK 2
A35015.0	15.00	0.5906	147.0	245.0	MK 2
A35015.25	15.25	0.6004	153.0	251.0	MK 2
A35015.5	15.50	0.6102	153.0	251.0	MK 2
A35015.75	15.75	0.6201	153.0	251.0	MK 2
A35016.0	16.00	0.6299	153.0	251.0	MK 2
A35016.25	16.25	0.6398	159.0	257.0	MK 2
A35016.5	16.50	0.6496	159.0	257.0	MK 2
A35016.75	16.75	0.6594	159.0	257.0	MK 2
A35017.0	17.00	0.6693	159.0	257.0	MK 2
A35017.25	17.25	0.6791	165.0	263.0	MK 2
A35017.5	17.50	0.6890	165.0	263.0	MK 2
A35018.0	18.00	0.7087	165.0	263.0	MK 2
A35018.5	18.50	0.7283	171.0	269.0	MK 2
A35019.0	19.00	0.7480	171.0	269.0	MK 2
A35019.5	19.50	0.7677	177.0	275.0	MK 2
A35019.75	19.75	0.7776	177.0	275.0	MK 2
A35020.0	20.00	0.7874	177.0	275.0	MK 2
A35020.25	20.25	0.7972	184.0	282.0	MK 2



Produkt	DC	DC	LCF	OAL	CZC MS
	(mm)	(inch)	(mm)	(mm)	
A35020.5	20.50	0.8071	184.0	282.0	MK 2
A35021.0	21.00	0.8268	184.0	282.0	MK 2
A35021.5	21.50	0.8465	191.0	289.0	MK 2
A35022.0	22.00	0.8661	191.0	289.0	MK 2
A35022.5	22.50	0.8858	198.0	296.0	MK 2
A35023.0	23.00	0.9055	198.0	296.0	MK 2
A35023.5	23.50	0.9252	198.0	319.0	MK 3
A35024.0	24.00	0.9449	206.0	327.0	MK 3
A35024.5	24.50	0.9646	206.0	327.0	MK 3
A35025.0	25.00	0.9843	206.0	327.0	MK 3
A35025.5	25.50	1.0039	214.0	335.0	MK 3
A35026.0	26.00	1.0236	214.0	335.0	MK 3
A35026.5	26.50	1.0433	214.0	335.0	MK 3
A35027.0	27.00	1.0630	222.0	343.0	MK 3
A35027.5	27.50	1.0827	222.0	343.0	MK 3
A35028.0	28.00	1.1024	222.0	343.0	MK 3
A35029.0	29.00	1.1417	230.0	351.0	MK 3
A35030.0	30.00	1.1811	230.0	351.0	MK 3
A35030.5	30.50	1.2008	239.0	360.0	MK 3
A35031.0	31.00	1.2205	239.0	360.0	MK 3

Produkt	DC	DC	LCF	OAL	CZC MS
	(mm)	(inch)	(mm)	(mm)	
A35031.5	31.50	1.2402	239.0	360.0	MK 3
A35032.0	32.00	1.2598	248.0	397.0	MK 4
A35033.0	33.00	1.2992	248.0	397.0	MK 4
A35034.0	34.00	1.3386	257.0	406.0	MK 4
A35035.0	35.00	1.3780	257.0	406.0	MK 4
A35036.0	36.00	1.4173	267.0	416.0	MK 4
A35037.0	37.00	1.4567	267.0	416.0	MK 4
A35038.0	38.00	1.4961	277.0	426.0	MK 4
A35039.0	39.00	1.5354	277.0	426.0	MK 4
A35040.0	40.00	1.5748	277.0	426.0	MK 4
A35041.0	41.00	1.6142	287.0	436.0	MK 4
A35042.0	42.00	1.6535	287.0	436.0	MK 4
A35043.0	43.00	1.6929	298.0	447.0	MK 4
A35044.0	44.00	1.7323	298.0	447.0	MK 4
A35045.0	45.00	1.7717	298.0	447.0	MK 4
A35046.0	46.00	1.8110	310.0	459.0	MK 4
A35047.0	47.00	1.8504	310.0	459.0	MK 4
A35048.0	48.00	1.8898	321.0	470.0	MK 4
A35050.0	50.00	1.9685	321.0	470.0	MK 4



A345



HSS Vrták dlouhý (dle DIN 1869/1), Parní temperace povrchu

Doporučen pro vrtání hlubokých otvorů nebo vrtání v těžko dostupných místech. Vrták s vrcholovým úhlem 118° a snadným přebrušováním. Parní temperace povrchu zadržuje reznou kapalinu na povrchu a brání nalepování třísek. Vhodný pro širokou oblast obráběných materiálů.

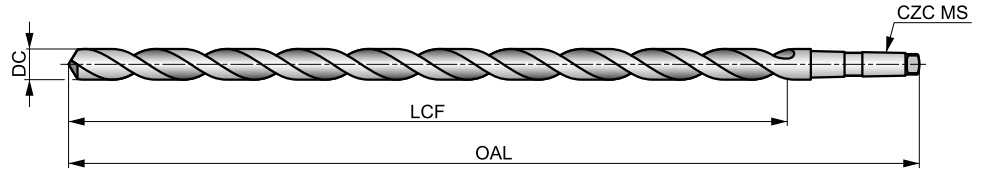

HSS	DIN 1870(1)	10×D
118°	ST	
λ 20-35°	R	DC h8

Skupiny obráběných materiálů, startovní řezná rychlost (Vc m/min) a kód posuvu. Tabulku s posuvem na otáčku naleznete od strany 175.

P1.1 ■ 23 G	P1.2 ■ 25 G	P1.3 ■ 26 G	P2.1 ■ 19 G	P2.2 ■ 17 E	P2.3 ■ 15 C	P3.1 ■ 9 D	P3.2 ■ 7 D	P3.3 ■ 6 C	P4.1 ■ 5 D	P4.2 ■ 4 C	P4.3 ■ 4 B	M1.1 ■ 16 C	M1.2 ■ 14 C
M2.1 ■ 15 C	M2.2 ■ 12 C	M3.1 ■ 5 E	M3.2 ■ 4 E	M3.3 ■ 4 E	M4.1 ■ 8 A	K1.1 ■ 22 G	K1.2 ■ 16 D	K1.3 ■ 12 D	K2.1 ■ 16 C	K2.2 ■ 13 C	K2.3 ■ 10 C	K3.1 ■ 14 C	K3.2 ■ 11 C
K3.3 ■ 9 C	K4.1 ■ 13 C	K4.2 ■ 10 C	K4.3 ■ 7 C	K4.4 ■ 6 C	K4.5 ■ 5 C	K5.1 ■ 15 C	K5.2 ■ 11 C	K5.3 ■ 9 C	N1.1 ■ 33 H	N1.2 ■ 25 H	N1.3 ■ 17 G	N2.1 ■ 42 F	N2.2 ■ 37 F
N2.3 ■ 27 F	N3.1 ■ 56 F	N3.2 ■ 33 G	N3.3 ■ 17 D	N4.1 ■ 30 J	N4.2 ■ 30 H	N4.3 ■ 10 F	S1.1 ■ 15 D	S1.2 ■ 9 B	S1.3 ■ 5 A	S2.1 ■ 5 C	S2.2 ■ 4 A	S3.1 ■ 4 C	S3.2 ■ 3 A
S4.1 ■ 3 C	S4.2 ■ 2 A												

DC > 25.4mm - kratší než 10xD.

Produkt	DC	DC	DC	LCF	OAL	CZC MS
	(inch)	(mm)	(inch)	(mm)	(mm)	
A3458.0	–	8.00	0.3150	165.0	265.0	MK 1
A3458.5	–	8.50	0.3346	165.0	265.0	MK 1
A3459.0	–	9.00	0.3543	175.0	275.0	MK 1
A3459.5	–	9.50	0.3740	175.0	275.0	MK 1
A3453/8	3/8	9.52	0.3750	185.0	285.0	MK 1
A34510.0	–	10.00	0.3937	185.0	285.0	MK 1
A34513/32	13/32	10.32	0.4063	185.0	285.0	MK 1
A34510.5	–	10.50	0.4134	185.0	285.0	MK 1
A34511.0	–	11.00	0.4331	195.0	300.0	MK 1
A3457/16	7/16	11.11	0.4375	195.0	300.0	MK 1
A34511.5	–	11.50	0.4528	195.0	300.0	MK 1
A34529/64	29/64	11.51	0.4531	205.0	310.0	MK 1
A34512.0	–	12.00	0.4724	205.0	310.0	MK 1
A34512.5	–	12.50	0.4921	205.0	310.0	MK 1
A3451/2	1/2	12.70	0.5000	205.0	310.0	MK 1
A34513.0	–	13.00	0.5118	205.0	310.0	MK 1
A34517/32	17/32	13.49	0.5313	220.0	325.0	MK 1
A34513.5	–	13.50	0.5315	220.0	325.0	MK 1
A34514.0	–	14.00	0.5512	220.0	325.0	MK 1
A3459/16	9/16	14.29	0.5625	220.0	340.0	MK 2
A34537/64	37/64	14.68	0.5781	220.0	340.0	MK 2
A34515.0	–	15.00	0.5906	220.0	340.0	MK 2
A34539/64	39/64	15.48	0.6094	230.0	355.0	MK 2

Produkt	DC	DC	DC	LCF	OAL	CZC MS
	(inch)	(mm)	(inch)	(mm)	(mm)	
A34515.5	–	15.50	0.6102	230.0	355.0	MK 2
A3455/8	5/8	15.88	0.6250	230.0	355.0	MK 2
A34516.0	–	16.00	0.6299	230.0	355.0	MK 2
A34541/64	41/64	16.27	0.6406	230.0	355.0	MK 2
A34516.5	–	16.50	0.6496	230.0	355.0	MK 2
A34521/32	21/32	16.67	0.6563	230.0	355.0	MK 2
A34517.0	–	17.00	0.6693	230.0	355.0	MK 2
A34511/16	11/16	17.46	0.6875	245.0	370.0	MK 2
A34517.5	–	17.50	0.6890	245.0	370.0	MK 2
A34518.0	–	18.00	0.7087	245.0	370.0	MK 2
A34518.5	–	18.50	0.7283	245.0	370.0	MK 2
A34519.0	–	19.00	0.7480	245.0	370.0	MK 2
A3453/4	3/4	19.05	0.7500	260.0	385.0	MK 2
A34519.5	–	19.50	0.7677	260.0	385.0	MK 2
A34520.0	–	20.00	0.7874	260.0	385.0	MK 2
A34520.5	–	20.50	0.8071	260.0	385.0	MK 2
A34521.0	–	21.00	0.8268	260.0	385.0	MK 2
A34521.5	–	21.50	0.8465	270.0	405.0	MK 2
A34522.0	–	22.00	0.8661	270.0	405.0	MK 2
A3457/8	7/8	22.22	0.8750	270.0	405.0	MK 2
A34522.5	–	22.50	0.8858	270.0	405.0	MK 3
A34523.0	–	23.00	0.9055	270.0	405.0	MK 3
A34523.5	–	23.50	0.9252	270.0	425.0	MK 3



Produkt	DC	DC	DC	LCF	OAL	CZC MS
	(inch)	(mm)	(inch)	(mm)	(mm)	
A34524.0	–	24.00	0.9449	290.0	440.0	MK 3
A34524.5	–	24.50	0.9646	290.0	440.0	MK 3
A34525.0	–	25.00	0.9843	290.0	440.0	MK 3
A3451	1"	25.40	1.0000	290.0	440.0	MK 3
A34525.5	–	25.50	1.0039	290.0	440.0	MK 3
A34526.0	–	26.00	1.0236	290.0	440.0	MK 3
A34526.5	–	26.50	1.0433	290.0	440.0	MK 3
A34527.0	–	27.00	1.0630	305.0	460.0	MK 3
A34528.0	–	28.00	1.1024	305.0	460.0	MK 3
A34529.0	–	29.00	1.1417	305.0	460.0	MK 3
A34530.0	–	30.00	1.1811	305.0	460.0	MK 3
A3451.1/4	1.1/4	31.75	1.2500	320.0	480.0	MK 3

Produkt	DC	DC	DC	LCF	OAL	CZC MS
	(inch)	(mm)	(inch)	(mm)	(mm)	
A34531.0	–	31.00	1.2205	320.0	480.0	MK 3
A34532.0	–	32.00	1.2598	320.0	505.0	MK 4
A34533.0	–	33.00	1.2992	320.0	505.0	MK 4
A34534.0	–	34.00	1.3386	340.0	530.0	MK 4
A34535.0	–	35.00	1.3780	340.0	530.0	MK 4
A34536.0	–	36.00	1.4173	340.0	530.0	MK 4
A34537.0	–	37.00	1.4567	340.0	530.0	MK 4
A34538.0	–	38.00	1.4961	360.0	555.0	MK 4
A3451.1/2	1.1/2	38.10	1.5000	360.0	555.0	MK 4
A34539.0	–	39.00	1.5354	360.0	555.0	MK 4
A34540.0	–	40.00	1.5748	360.0	555.0	MK 4



A951



HSS PFX extra dlouhý vrták s kuželovou stopkou (DIN 1870/1), Leštěný

Univerzální vrták s parabolickou konstrukcí drážky pro vrtání hlubokých otvorů na jeden průchod. Vrták má samostředící vrcholový úhel 130° (doporučeno středění předvrtáním krátkým PFX vrtákem). Konstrukce snižuje řezné síly. Vhodný pro širokou oblast obráběných materiálů.

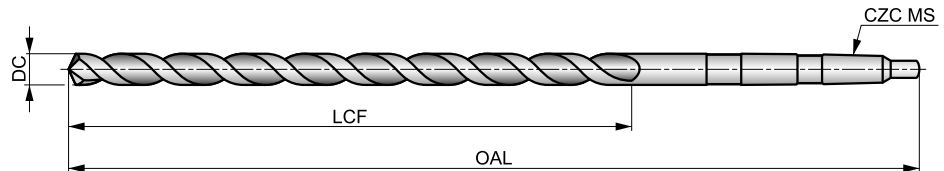

HSS	DIN 1870(1)	15xD
130°	Bright ST	
$\lambda > 35^\circ$	R	DC h8

Skupiny obráběných materiálů, startovní řezná rychlost (Vc m/min) a kód posuvu. Tabulku s posuvem na otáčku naleznete od strany 175.

P1.1 ■ 25 G	P1.2 ■ 28 G	P1.3 ■ 29 G	P2.1 ■ 22 G	P2.2 ■ 19 E	P2.3 ■ 17 C	P3.1 ■ 12 D	P3.2 ■ 9 D	P3.3 ■ 8 C	P4.1 ■ 7 D	P4.2 ■ 6 C	P4.3 ■ 5 B	M1.1 ■ 16 C	M1.2 ■ 14 C
M2.1 ■ 15 C	M2.2 ■ 12 C	M3.1 ■ 7 E	M3.2 ■ 6 E	M3.3 ■ 5 E	M4.1 ■ 12 A	K1.1 ■ 22 G	K1.2 ■ 16 D	K1.3 ■ 12 D	K2.1 ■ 16 C	K2.2 ■ 13 C	K2.3 ■ 10 C	K3.1 ■ 14 C	K3.2 ■ 11 C
K3.3 ■ 9 C	K4.1 ■ 13 C	K4.2 ■ 10 C	K4.3 ■ 7 C	K4.4 ■ 6 C	K4.5 ■ 5 C	K5.1 ■ 15 C	K5.2 ■ 11 C	K5.3 ■ 9 C	N1.1 ■ 30 H	N1.2 ■ 23 H	N1.3 ■ 15 G	N2.1 ■ 37 F	N2.2 ■ 33 F
N2.3 ■ 24 F	N3.1 ■ 56 F	N3.2 ■ 33 G	N3.3 ■ 17 D	N4.1 ■ 30 J	N4.2 ■ 30 H	N4.3 ■ 10 F	S1.1 ■ 18 D	S1.2 ■ 10 B	S1.3 ■ 6 A	S2.1 ■ 7 C	S2.2 ■ 4 A	S3.1 ■ 5 C	S3.2 ■ 3 A
S4.1 ■ 4 C	S4.2 ■ 2 A												

DC >= 14.5mm - kratší než 15xD, DC > 23mm - leštěný.

Produkt	DC	DC	LCF	OAL	CZC MS
	(mm)	(inch)			
A95110.0	10.00	0.3937	185.0	285.0	MK 1
A95111.0	11.00	0.4331	195.0	300.0	MK 1
A95112.0	12.00	0.4724	205.0	310.0	MK 1
A95112.5	12.50	0.4921	205.0	310.0	MK 1
A95113.0	13.00	0.5118	205.0	310.0	MK 1
A95113.5	13.50	0.5315	220.0	325.0	MK 1
A95114.0	14.00	0.5512	220.0	325.0	MK 1
A95114.5	14.50	0.5709	220.0	340.0	MK 2
A95115.0	15.00	0.5906	220.0	340.0	MK 2
A95115.5	15.50	0.6102	230.0	355.0	MK 2
A95116.0	16.00	0.6299	230.0	355.0	MK 2
A95116.5	16.50	0.6496	230.0	355.0	MK 2
A95117.0	17.00	0.6693	230.0	355.0	MK 2
A95117.5	17.50	0.6890	245.0	370.0	MK 2
A95118.0	18.00	0.7087	245.0	370.0	MK 2

Produkt	DC	DC	LCF	OAL	CZC MS
	(mm)	(inch)			
A95118.5	18.50	0.7283	245.0	370.0	MK 2
A95119.0	19.00	0.7480	245.0	370.0	MK 2
A95119.5	19.50	0.7677	260.0	385.0	MK 2
A95120.0	20.00	0.7874	260.0	385.0	MK 2
A95121.0	21.00	0.8268	260.0	385.0	MK 2
A95122.0	22.00	0.8661	270.0	405.0	MK 2
A95123.0	23.00	0.9055	270.0	405.0	MK 2
A95124.0	24.00	0.9449	290.0	440.0	MK 3
A95125.0	25.00	0.9843	290.0	440.0	MK 3
A95126.0	26.00	1.0236	290.0	440.0	MK 3
A95127.0	27.00	1.0630	305.0	460.0	MK 3
A95128.0	28.00	1.1024	305.0	460.0	MK 3
A95129.0	29.00	1.1417	305.0	460.0	MK 3
A95130.0	30.00	1.1811	305.0	460.0	MK 3



A952



HSS PFX extra dlouhý vrták s kuželovou stopkou (DIN 1870/2), Leštěný

Univerzální vrták s parabolickou konstrukcí drážky pro vrtání hlubokých otvorů na jeden průchod. Vrták má samostředící vrcholový úhel 130° (doporučeno středění předvrtáním krátkým PFX vrtákem). Konstrukce snižuje řezné síly. Vhodný pro širokou oblast obráběných materiálů.

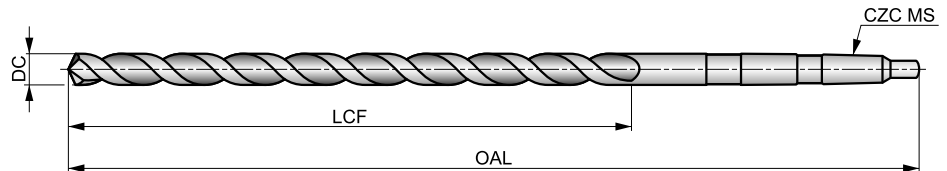

HSS	DIN 1870(2)	20xD
130°	Bright ST	
$\lambda > 35^\circ$	R	DC h8

Skupiny obráběných materiálů, startovní řezná rychlost (Vc m/min) a kód posuvu. Tabulku s posuvem na otáčku naleznete od strany 175.

P1.1 ■ 25 G	P1.2 ■ 28 G	P1.3 ■ 29 G	P2.1 ■ 22 G	P2.2 ■ 19 E	P2.3 ■ 17 C	P3.1 ■ 12 D	P3.2 ■ 9 D	P3.3 ■ 8 C	P4.1 ■ 7 D	P4.2 ■ 6 C	P4.3 ■ 5 B	M1.1 ■ 16 C	M1.2 ■ 14 C
M2.1 ■ 15 C	M2.2 ■ 12 C	M3.1 ■ 17 E	M3.2 ■ 16 E	M3.3 ■ 5 E	M4.1 ■ 12 A	K1.1 ■ 22 G	K1.2 ■ 16 D	K1.3 ■ 12 D	K2.1 ■ 16 C	K2.2 ■ 13 C	K2.3 ■ 10 C	K3.1 ■ 14 C	K3.2 ■ 11 C
K3.3 ■ 9 C	K4.1 ■ 13 C	K4.2 ■ 10 C	K4.3 ■ 7 C	K4.4 ■ 6 C	K4.5 ■ 5 C	K5.1 ■ 15 C	K5.2 ■ 11 C	K5.3 ■ 9 C	N1.1 ■ 30 H	N1.2 ■ 23 H	N1.3 ■ 15 G	N2.1 ■ 37 F	N2.2 ■ 33 F
N2.3 ■ 24 F	N3.1 ■ 56 F	N3.2 ■ 33 G	N3.3 ■ 17 D	N4.1 ■ 30 J	N4.2 ■ 30 H	N4.3 ■ 10 F	S1.1 ■ 18 D	S1.2 ■ 10 B	S1.3 ■ 6 A	S2.1 ■ 7 C	S2.2 ■ 4 A	S3.1 ■ 5 C	S3.2 ■ 3 A
S4.1 ■ 4 C	S4.2 ■ 2 A												

DC >= 14.5mm - kratší než 20xD, DC > 23mm - leštěný.

Produkt	DC	DC	LCF	OAL	CZC MS	Produkt	DC	DC	LCF	OAL	CZC MS
	(mm)	(inch)					(mm)	(mm)			
A9528.0	8.00	0.3150	210.0	330.0	MK 1	A95219.0	19.00	0.7480	310.0	465.0	MK 2
A9528.5	8.50	0.3346	210.0	330.0	MK 1	A95219.5	19.50	0.7677	325.0	490.0	MK 2
A9529.0	9.00	0.3543	220.0	345.0	MK 1	A95220.0	20.00	0.7874	325.0	490.0	MK 2
A95210.0	10.00	0.3937	235.0	360.0	MK 1	A95221.0	21.00	0.8268	325.0	490.0	MK 2
A95210.5	10.50	0.4134	235.0	360.0	MK 1	A95222.0	22.00	0.8661	345.0	515.0	MK 2
A95211.0	11.00	0.4331	250.0	375.0	MK 1	A95223.0	23.00	0.9055	345.0	515.0	MK 2
A95211.5	11.50	0.4528	250.0	375.0	MK 1	A95224.0	24.00	0.9449	365.0	555.0	MK 3
A95212.0	12.00	0.4724	260.0	395.0	MK 1	A95225.0	25.00	0.9843	365.0	555.0	MK 3
A95212.5	12.50	0.4921	260.0	395.0	MK 1	A95226.0	26.00	1.0236	365.0	555.0	MK 3
A95213.0	13.00	0.5118	260.0	395.0	MK 1	A95227.0	27.00	1.0630	385.0	580.0	MK 3
A95213.5	13.50	0.5315	275.0	410.0	MK 1	A95228.0	28.00	1.1024	385.0	580.0	MK 3
A95214.0	14.00	0.5512	275.0	410.0	MK 1	A95229.0	29.00	1.1417	385.0	580.0	MK 3
A95214.5	14.50	0.5709	275.0	425.0	MK 2	A95230.0	30.00	1.1811	385.0	580.0	MK 3
A95215.0	15.00	0.5906	275.0	425.0	MK 2	A95231.0	31.00	1.2205	410.0	610.0	MK 3
A95215.5	15.50	0.6102	295.0	445.0	MK 2	A95232.0	32.00	1.2598	410.0	635.0	MK 4
A95216.0	16.00	0.6299	295.0	445.0	MK 2	A95233.0	33.00	1.2992	410.0	635.0	MK 4
A95216.5	16.50	0.6496	295.0	445.0	MK 2	A95234.0	34.00	1.3386	430.0	665.0	MK 4
A95217.0	17.00	0.6693	295.0	445.0	MK 2	A95235.0	35.00	1.3780	430.0	665.0	MK 4
A95217.5	17.50	0.6890	310.0	465.0	MK 2	A95238.0	38.00	1.4961	460.0	695.0	MK 4
A95218.0	18.00	0.7087	310.0	465.0	MK 2	A95240.0	40.00	1.5748	460.0	695.0	MK 4
A95218.5	18.50	0.7283	310.0	465.0	MK 2						



A400



HSS Stupňovitý vrták, Parní temperace povrchu

Univerzální nástroj pro vrtání zahloubených otvorů pro standartní metrické závity. Vrcholový úhel vrtáku 118° a zahloubení 90°. Parní temperace povrchu zadržuje reznou kapalinu a brání nalepování třísek. Vhodný pro CNC i klasické stroje a širokou oblast obráběných materiálů.

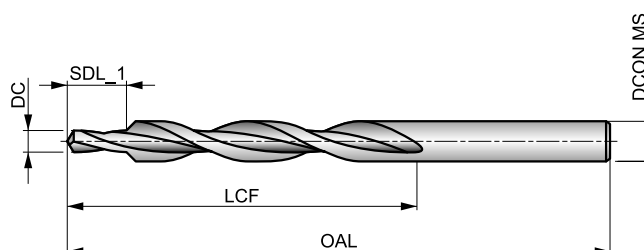

HSS	DIN 8374	4xD
90°	ST	
λ 20-35°	R	118°

Skupiny obráběných materiálů, startovní řezná rychlost (Vc m/min) a kód posuvu. Tabulku s posuvem na otáčku naleznete od strany 175.

P1.1 ■ 29 G	P1.2 ■ 33 G	P1.3 ■ 34 G	P2.1 ■ 25 G	P2.2 ■ 22 E	P2.3 ■ 19 C	P3.1 ■ 15 E	P3.2 ■ 12 E	P3.3 ■ 10 C	P4.1 ■ 9 E	P4.2 ■ 7 C	P4.3 ■ 6 C	M1.1 ■ 22 E	M1.2 ■ 19 E
M2.1 ■ 20 E	M2.2 ■ 16 E	M3.1 ■ 10 G	M3.2 ■ 9 G	M3.3 ■ 8 G	M4.1 ■ 12 C	K1.1 ■ 30 G	K1.2 ■ 22 E	K1.3 ■ 17 E	K2.1 ■ 23 E	K2.2 ■ 19 E	K2.3 ■ 15 C	K3.1 ■ 21 E	K3.2 ■ 16 E
K3.3 ■ 13 C	K4.1 ■ 19 E	K4.2 ■ 14 E	K4.3 ■ 11 C	K4.4 ■ 9 C	K4.5 ■ 8 C	K5.1 ■ 22 E	K5.2 ■ 16 E	K5.3 ■ 13 C	N1.1 ■ 45 E	N1.2 ■ 34 E	N1.3 ■ 23 E	N2.1 ■ 49 E	N2.2 ■ 44 E
N2.3 ■ 32 E	N3.1 ■ 68 E	N3.2 ■ 40 E	N3.3 ■ 20 E	N4.1 ■ 30 I	S1.1 ■ 23 E	S1.2 ■ 14 C	S1.3 ■ 8 A	S2.1 ■ 8 C	S2.2 ■ 6 A	S3.1 ■ 6 C	S3.2 ■ 4 A	S4.1 ■ 5 C	S4.2 ■ 3 A

Produkt	TDZ	DC	DC	LCF	OAL	SDL_1	DCON MS
		(mm)	(inch)				
A400M3	M3	3.20	0.1260	57.0	93.0	9.00	6.00
A400M4	M4	4.30	0.1693	75.0	117.0	11.00	8.00
A400M5	M5	5.30	0.2087	87.0	133.0	13.00	10.00
A400M6	M6	6.40	0.2520	94.0	142.0	15.00	11.50
A400M8	M8	8.40	0.3307	114.0	169.0	19.00	15.00
A400M10	M10	10.50	0.4134	135.0	198.0	23.00	19.00



A402



HSS Stupňovitý vrták, Parní temperace povrchu

Vrtací část má vrcholový úhel 118°, záhlubník 180°. Doporučeno pro vrtání a zahlubování standardních otvorů pro metrické závity. Parní temperace povrchu zadržuje řeznou kapalinu na povrchu a brání nalepování třísek. Vhodný pro širokou oblast obráběných materiálů.

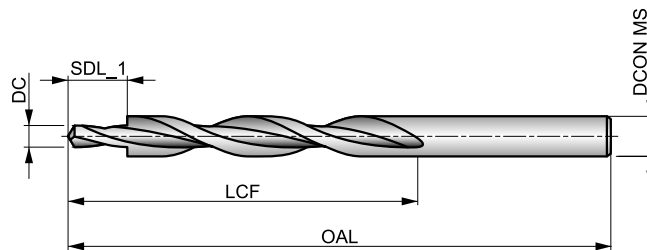

HSS	DIN 8376	4xD
180°	ST	
λ 20-35°	R	118°

Skupiny obráběných materiálů, startovní řezná rychlost (Vc m/min) a kód posuvu. Tabulku s posuvem na otáčku naleznete od strany 175.

P1.1 ■ 29 G	P1.2 ■ 33 G	P1.3 ■ 34 G	P2.1 ■ 25 G	P2.2 ■ 22 E	P2.3 ■ 19 C	P3.1 ■ 15 E	P3.2 ■ 12 E	P3.3 ■ 10 C	P4.1 ■ 9 E	P4.2 ■ 17 C	P4.3 ■ 6 C	M1.1 ■ 22 E	M1.2 ■ 19 E
M2.1 ■ 20 E	M2.2 ■ 16 E	M3.1 ■ 10 G	M3.2 ■ 9 G	M3.3 ■ 8 G	M4.1 ■ 12 C	K1.1 ■ 30 G	K1.2 ■ 22 E	K1.3 ■ 17 E	K2.1 ■ 23 E	K2.2 ■ 19 E	K2.3 ■ 15 C	K3.1 ■ 21 E	K3.2 ■ 16 E
K3.3 ■ 13 C	K4.1 ■ 19 E	K4.2 ■ 14 E	K4.3 ■ 11 C	K4.4 ■ 9 C	K4.5 ■ 8 C	K5.1 ■ 22 E	K5.2 ■ 16 E	K5.3 ■ 13 C	N1.1 ■ 45 E	N1.2 ■ 34 E	N1.3 ■ 23 E	N2.1 ■ 49 E	N2.2 ■ 44 E
N2.3 ■ 32 E	N3.1 ■ 68 E	N3.2 ■ 40 E	N3.3 ■ 20 E	N4.1 ■ 30 I	S1.1 ■ 23 E	S1.2 ■ 14 C	S1.3 ■ 8 A	S2.1 ■ 8 C	S2.2 ■ 6 A	S3.1 ■ 6 C	S3.2 ■ 4 A	S4.1 ■ 5 C	S4.2 ■ 3 A

Produkt	TDZ	DC	DC	LCF	OAL	SDL_1	DCON MS
		(mm)	(inch)				
A402M3	M3	3.40	0.1339	57.0	93.0	9.00	6.00
A402M4	M4	4.50	0.1772	75.0	117.0	11.00	8.00
A402M5	M5	5.50	0.2165	87.0	133.0	13.00	10.00
A402M6	M6	6.60	0.2598	94.0	142.0	15.00	11.00
A402M8	M8	9.00	0.3543	114.0	169.0	19.00	15.00
A402M10	M10	11.00	0.4331	130.0	191.0	23.00	18.00



A405



HSS Stupňovitý vrták s kuželovou stopkou, Parní temperace povrchu

Univerzální nástroj pro vrtání zahloubených otvorů pro standardní metrické závity. Vrcholový úhel vrtáku 118° a zahloubení 180°. Parní temperace povrchu zadržuje řeznou kapalinu a brání nalepování třísek. Vhodný pro CNC i klasické stroje a širokou oblast obráběných materiálů.

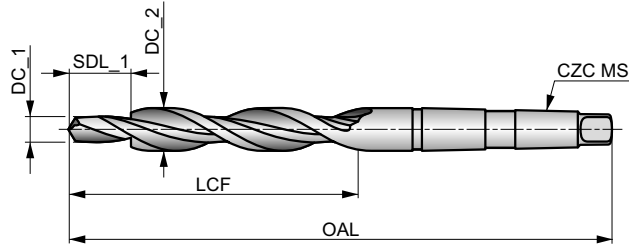

HSS	DIN 8377	4xD
180°	ST	
λ 20-35°	R	118°

Skupiny obráběných materiálů, startovní řezná rychlost (Vc m/min) a kód posuvu. Tabulku s posuvem na otáčku naleznete od strany 175.

P1.1 ■ 29 G	P1.2 ■ 33 G	P1.3 ■ 34 G	P2.1 ■ 25 G	P2.2 ■ 22 E	P2.3 ■ 19 C	P3.1 ■ 15 E	P3.2 ■ 12 E	P3.3 ■ 10 C	P4.1 ■ 9 E	P4.2 ■ 7 C	P4.3 ■ 6 C	M1.1 ■ 22 E	M1.2 ■ 19 E
M2.1 ■ 20 E	M2.2 ■ 16 E	M3.1 ■ 10 G	M3.2 ■ 9 G	M3.3 ■ 8 G	M4.1 ■ 12 C	K1.1 ■ 30 G	K1.2 ■ 22 E	K1.3 ■ 17 E	K2.1 ■ 23 E	K2.2 ■ 19 E	K2.3 ■ 15 C	K3.1 ■ 21 E	K3.2 ■ 16 E
K3.3 ■ 13 C	K4.1 ■ 19 E	K4.2 ■ 14 E	K4.3 ■ 11 C	K4.4 ■ 9 C	K4.5 ■ 8 C	K5.1 ■ 22 E	K5.2 ■ 16 E	K5.3 ■ 13 C	N1.1 ■ 45 E	N1.2 ■ 34 E	N1.3 ■ 23 E	N2.1 ■ 49 E	N2.2 ■ 44 E
N2.3 ■ 32 E	N3.1 ■ 68 E	N3.2 ■ 40 E	N3.3 ■ 20 E	N4.1 ■ 30 I	S1.1 ■ 23 E	S1.2 ■ 14 C	S1.3 ■ 8 A	S2.1 ■ 8 C	S2.2 ■ 6 A	S3.1 ■ 6 C	S3.2 ■ 4 A	S4.1 ■ 5 C	S4.2 ■ 3 A

Produkt	TDZ	DC_1	DC_1	DC_2	LCF	OAL	SDL_1	CZC MS
		(mm)	(inch)	(mm)	(mm)	(mm)	(mm)	
A405M6	M6	6.60	0.2598	11.00	94.0	175.0	15.00	MK 1
A405M8	M8	9.00	0.3543	15.00	114.0	212.0	19.00	MK 2
A405M10	M10	11.00	0.4331	18.00	130.0	228.0	23.00	MK 2
A405M12	M12	13.50	0.5315	20.00	140.0	238.0	27.00	MK 2
A405M14	M14	15.50	0.6102	24.00	160.0	281.0	31.00	MK 3
A405M16	M16	17.50	0.6890	26.00	165.0	286.0	35.00	MK 3
A405M18	M18	20.00	0.7874	30.00	175.0	296.0	39.00	MK 3



A412



HSS Stupňovitý vrták, Parní temperace povrchu

Konstruován k vrtání a zahloubení otvorů pro standardní metrické závity. Vrcholový úhel vrtáku 118° a zahloubení 90°. Parní temperace povrchu zadržuje řeznou kapalinu a brání nalepování třísek. Vhodný pro CNC i klasické stroje a širokou oblast obráběných materiálů.

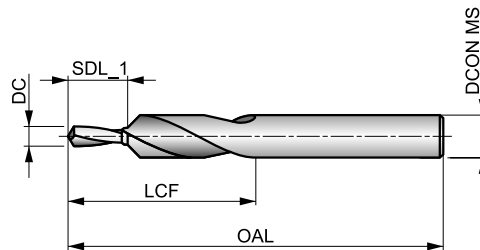

HSS	DORMER	2.5×D
90°	ST	
R	118°	

Skupiny obráběných materiálů, startovní řezná rychlost (Vc m/min) a kód posuvu. Tabulku s posuvem na otáčku naleznete od strany 175.

P1.1 ■ 29 I	P1.2 ■ 33 I	P1.3 ■ 34 I	P2.1 ■ 25 I	P2.2 ■ 22 G	P2.3 ■ 19 E	P3.1 ■ 15 G	P3.2 ■ 12 G	P3.3 ■ 10 E	P4.1 ■ 9 G	P4.2 ■ 7 E	P4.3 ■ 6 C	M1.1 ■ 22 G	M1.2 ■ 19 G
M2.1 ■ 20 G	M2.2 ■ 16 G	M3.1 ■ 10 I	M3.2 ■ 9 I	M3.3 ■ 8 I	M4.1 ■ 12 E	K1.1 ■ 30 G	K1.2 ■ 22 E	K1.3 ■ 17 E	K2.1 ■ 23 E	K2.2 ■ 19 E	K2.3 ■ 15 E	K3.1 ■ 21 E	K3.2 ■ 16 E
K3.3 ■ 13 E	K4.1 ■ 19 E	K4.2 ■ 14 E	K4.3 ■ 11 E	K4.4 ■ 9 E	K4.5 ■ 8 E	K5.1 ■ 22 E	K5.2 ■ 16 E	K5.3 ■ 13 E	N1.1 ■ 45 G	N1.2 ■ 34 G	N1.3 ■ 23 G	N2.1 ■ 42 G	N2.2 ■ 37 G
N2.3 ■ 27 G	N3.1 ■ 68 G	N3.2 ■ 40 G	N3.3 ■ 20 G	N4.1 ■ 30 I	S1.1 ■ 27 G	S1.2 ■ 16 E	S1.3 ■ 8 C	S2.1 ■ 11 G	S2.2 ■ 6 C	S3.1 ■ 8 G	S3.2 ■ 4 C	S4.1 ■ 6 G	S4.2 ■ 3 C

Produkt	TDZ	DC	DC	LCF	OAL	SDL_1	DCON MS
		(mm)	(inch)				
A412M3	M3	3.40	0.1339	31.0	70.0	9.00	6.60
A412M4	M4	4.50	0.1772	40.0	84.0	11.00	9.00
A412M5	M5	5.50	0.2165	47.0	95.0	13.00	11.00
A412M6	M6	6.60	0.2598	51.0	102.0	15.00	13.00
A412M8	M8	9.00	0.3543	62.0	123.0	19.00	17.20
A412M10	M10	11.00	0.4331	70.0	141.0	23.00	21.50



A413



HSS Stupňovitý vrták, Parní temperace povrchu

Univerzální nástroj pro vrtání zahloubených otvorů pro standardní metrické závity. Vrcholový úhel vrtáku 118° a zahloubení 180°. Parní temperace povrchu zadržuje řeznou kapalinu a brání nalepování třísek. Vhodný pro CNC i klasické stroje a širokou oblast obráběných materiálů.

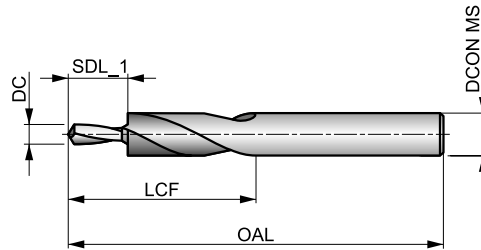

HSS	DORMER	2.5xD
180°	ST	
R	118°	

Skupiny obráběných materiálů, startovní řezná rychlost (Vc m/min) a kód posuvu. Tabulku s posuvem na otáčku naleznete od strany 175.

P1.1 ■ 29 I	P1.2 ■ 33 I	P1.3 ■ 34 I	P2.1 ■ 25 I	P2.2 ■ 22 G	P2.3 ■ 19 E	P3.1 ■ 15 G	P3.2 ■ 12 G	P3.3 ■ 10 E	P4.1 ■ 9 G	P4.2 ■ 7 E	P4.3 ■ 6 C	M1.1 ■ 22 G	M1.2 ■ 19 G
M2.1 ■ 20 G	M2.2 ■ 16 G	M3.1 ■ 10 I	M3.2 ■ 19 I	M3.3 ■ 8 I	M4.1 ■ 12 E	K1.1 ■ 30 G	K1.2 ■ 22 E	K1.3 ■ 17 E	K2.1 ■ 23 E	K2.2 ■ 19 E	K2.3 ■ 15 E	K3.1 ■ 21 E	K3.2 ■ 16 E
K3.3 ■ 13 E	K4.1 ■ 19 E	K4.2 ■ 14 E	K4.3 ■ 11 E	K4.4 ■ 9 E	K4.5 ■ 8 E	K5.1 ■ 22 E	K5.2 ■ 16 E	K5.3 ■ 13 E	N1.1 ■ 45 G	N1.2 ■ 34 G	N1.3 ■ 23 G	N2.1 ■ 42 G	N2.2 ■ 37 G
N2.3 ■ 27 G	N3.1 ■ 68 G	N3.2 ■ 40 G	N3.3 ■ 20 G	N4.1 ■ 30 I	S1.1 ■ 27 G	S1.2 ■ 16 E	S1.3 ■ 8 C	S2.1 ■ 11 G	S2.2 ■ 6 C	S3.1 ■ 8 G	S3.2 ■ 4 C	S4.1 ■ 6 G	S4.2 ■ 3 C

Produkt	TDZ	DC	DC	LCF	OAL	SDL_1	DCON MS
		(mm)	(inch)				
A413M3	M3	3.40	0.1339	28.0	66.0	9.00	6.00
A413M4	M4	4.50	0.1772	37.0	79.0	11.00	8.00
A413M5	M5	5.50	0.2165	43.0	89.0	13.00	10.00
A413M6	M6	6.60	0.2598	47.0	95.0	15.00	11.00
A413M8	M8	9.00	0.3543	56.0	111.0	19.00	15.00
A413M10	M10	11.00	0.4331	62.0	123.0	23.00	18.00



A200

DORMER



HSS Navrtávák, 118° vrcholový úhel, 60° zahloubení, Leštěný

Doporučen pro navrtání přesného otvoru na koncích hřídelí pro bezpečné upnutí před obráběním. Dva vrtací konce nástroje zvyšují životnost nástroje. Vhodný pro širokou oblast obráběných materiálů.

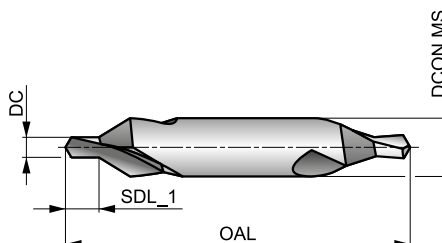

HSS	DIN 333A	1×D
60°	Bright	
R	118°	

Skupiny obráběných materiálů, startovní řezná rychlost (Vc m/min) a kód posuvu. Tabulku s posuvem na otáčku naleznete od strany 175.

P1.1 ■ 33 I	P1.2 ■ 37 I	P1.3 ■ 38 I	P2.1 ■ 28 I	P2.2 ■ 25 G	P2.3 ■ 22 E	P3.1 ■ 19 F	P3.2 ■ 15 F	P3.3 ■ 13 E	P4.1 ■ 11 F	P4.2 ■ 10 E	P4.3 ■ 8 D	M1.1 ■ 21 E	M1.2 ■ 17 E
M2.1 ■ 18 E	M2.2 ■ 15 E	M3.1 ■ 9 G	M3.2 ■ 8 G	M3.3 ■ 7 G	M4.1 ■ 10 C	K1.1 ■ 30 I	K1.2 ■ 22 F	K1.3 ■ 17 F	K2.1 ■ 25 E	K2.2 ■ 20 E	K2.3 ■ 16 E	K3.1 ■ 22 E	K3.2 ■ 17 E
K3.3 ■ 13 E	K4.1 ■ 20 E	K4.2 ■ 15 E	K4.3 ■ 11 E	K4.4 ■ 10 E	K4.5 ■ 8 E	K5.1 ■ 23 E	K5.2 ■ 17 E	K5.3 ■ 13 E	N1.1 ■ 33 J	N1.2 ■ 25 J	N1.3 ■ 17 I	N2.1 ■ 42 H	N2.2 ■ 37 H
N2.3 ■ 27 H	N3.1 ■ 56 H	N3.2 ■ 33 I	N3.3 ■ 17 G	N4.1 ■ 30 J	N4.2 ■ 28 H	N4.3 ■ 14 F	S1.1 ■ 24 F	S1.2 ■ 13 D	S1.3 ■ 7 B	S2.1 ■ 7 E	S2.2 ■ 6 A	S3.1 ■ 5 E	S3.2 ■ 4 A
S4.1 ■ 4 E	S4.2 ■ 3 A												

Produkty nabízíme i v sadě. Vyhledejte A296.

Produkt	DC	DC	SDL_1	OAL	DC ON MS
	(mm)	(inch)	(mm)	(mm)	(mm)
A200.5X3.15 ¹⁾	0.50	0.0197	0.9 - 0.6	25.0	3.15
A200.8X3.15 ¹⁾	0.80	0.0315	1.3 - 1.0	25.0	3.15
A2001.0X3.15	1.00	0.0394	1.7 - 1.3	31.0	3.15
A2001.25X3.15	1.25	0.0492	2.0 - 1.6	31.0	3.15
A2001.6X4.0	1.60	0.0630	2.6 - 2.0	35.0	4.00
A2002.0X5.0	2.00	0.0787	3.1 - 2.5	40.0	5.00
A2002.5X6.3	2.50	0.0984	3.8 - 3.1	45.0	6.30
A2003.15X8.0	3.15	0.1240	4.6 - 3.9	50.0	8.00
A2004.0X10.0	4.00	0.1575	5.9 - 5.0	55.0	10.00
A2005.0X12.5	5.00	0.1969	7.2 - 6.3	63.0	12.50
A2006.3X16.0	6.30	0.2480	8.9 - 8.0	71.0	16.00
A2008.0X20.0	8.00	0.3150	11.1 - 10.1	80.0	20.00
A20010.0X25.0	10.00	0.3937	13.8 - 12.8	100.0	25.00
A20012.5X31.5	12.50	0.4921	17.5 - 16.5	125.0	31.50

¹⁾ Vhodný pro průchozí otvory.



A205



HSS Navrtávák, 118° vrcholový úhel, 60° zahloubení, Povlakovaný TiN

Doporučen pro navrtání přesného otvoru na koncích hřídelí pro bezpečné upnutí před obráběním. Dva vrtací konce nástroje zvyšují životnost nástroje. Povlak TiN pro vyšší produktivitu a delší životnost. Vhodný pro širokou oblast obráběných materiálů.

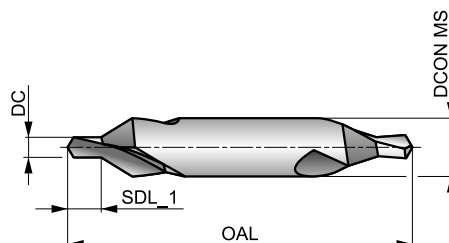

HSS	DIN 333A	1xD
60°	TiN	
R	118°	

Skupiny obráběných materiálů, startovní řezná rychlost (Vc m/min) a kód posuvu. Tabulku s posuvem na otáčku naleznete od strany 175.

P1.1 ■ 40 I	P1.2 ■ 45 I	P1.3 ■ 46 I	P2.1 ■ 34 I	P2.2 ■ 30 G	P2.3 ■ 27 E	P3.1 ■ 24 F	P3.2 ■ 19 F	P3.3 ■ 16 E	P4.1 ■ 14 F	P4.2 ■ 12 E	P4.3 ■ 10 D	M1.1 ■ 25 E	M1.2 ■ 21 E
M2.1 ■ 22 E	M2.2 ■ 18 E	M3.1 ■ 12 G	M3.2 ■ 10 G	M3.3 ■ 9 G	M4.1 ■ 12 C	K1.1 ■ 36 I	K1.2 ■ 27 F	K1.3 ■ 20 F	K2.1 ■ 30 E	K2.2 ■ 24 E	K2.3 ■ 19 E	K3.1 ■ 26 E	K3.2 ■ 20 E
K3.3 ■ 16 E	K4.1 ■ 24 E	K4.2 ■ 18 E	K4.3 ■ 13 E	K4.4 ■ 11 E	K4.5 ■ 10 E	K5.1 ■ 27 E	K5.2 ■ 21 E	K5.3 ■ 16 E	N1.1 ■ 40 J	N1.2 ■ 30 J	N1.3 ■ 20 I	N2.1 ■ 49 H	N2.2 ■ 44 H
N2.3 ■ 32 H	N3.1 ■ 68 H	N3.2 ■ 40 I	N3.3 ■ 20 G	N4.1 ■ 36 J	N4.2 ■ 34 H	N4.3 ■ 17 F	S1.1 ■ 29 F	S1.2 ■ 16 D	S1.3 ■ 8 B	S2.1 ■ 8 E	S2.2 ■ 7 A	S3.1 ■ 6 E	S3.2 ■ 5 A
S4.1 ■ 5 E	S4.2 ■ 4 A												

Produkt	DC	DC	SDL_1	OAL	DCON MS
	(mm)	(inch)			
A2051.0X3.15	1.00	0.0394	1.7 - 1.3	31.0	3.15
A2051.25X3.15	1.25	0.0492	2.0 - 1.6	31.0	3.15
A2051.6X4.0	1.60	0.0630	2.6 - 2.0	35.0	4.00
A2052.0X5.0	2.00	0.0787	3.1 - 2.5	40.0	5.00
A2052.5X6.3	2.50	0.0984	3.8 - 3.1	45.0	6.30
A2053.15X8.0	3.15	0.1240	4.6 - 3.9	50.0	8.00
A2054.0X10.0	4.00	0.1575	5.9 - 5.0	55.0	10.00
A2055.0X12.5	5.00	0.1969	7.2 - 6.3	63.0	12.50



A206



HSS-E Navrtávák, 118° vrcholový úhel, 60° zahloubení, Leštěný

Doporučen pro navrtání přesného otvoru na koncích hřídelí pro bezpečné upnutí před obráběním. Dva vrtací konce nástroje zvyšují životnost nástroje. Vhodný pro širokou oblast obráběných materiálů.

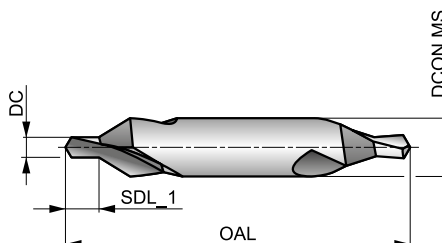

HSS-E	DIN 333A	1×D
60°	Bright	
R	118°	

Skupiny obráběných materiálů, startovní řezná rychlost (Vc m/min) a kód posuvu. Tabulku s posuvem na otáčku naleznete od strany 175.

P1.1 ■ 40 I	P1.2 ■ 45 I	P1.3 ■ 46 I	P2.1 ■ 34 I	P2.2 ■ 30 G	P2.3 ■ 27 E	P3.1 ■ 24 F	P3.2 ■ 19 F	P3.3 ■ 16 E	P4.1 ■ 14 F	P4.2 ■ 12 E	P4.3 ■ 10 D	M1.1 ■ 25 E	M1.2 ■ 21 E
M2.1 ■ 22 E	M2.2 ■ 18 E	M3.1 ■ 12 G	M3.2 ■ 10 G	M3.3 ■ 9 G	M4.1 ■ 12 C	K1.1 ■ 36 I	K1.2 ■ 27 F	K1.3 ■ 20 F	K2.1 ■ 30 E	K2.2 ■ 24 E	K2.3 ■ 19 E	K3.1 ■ 26 E	K3.2 ■ 20 E
K3.3 ■ 16 E	K4.1 ■ 24 E	K4.2 ■ 18 E	K4.3 ■ 13 E	K4.4 ■ 11 E	K4.5 ■ 10 E	K5.1 ■ 27 E	K5.2 ■ 21 E	K5.3 ■ 16 E	N1.1 ■ 40 J	N1.2 ■ 30 J	N1.3 ■ 20 I	N2.1 ■ 49 H	N2.2 ■ 44 H
N2.3 ■ 32 H	N3.1 ■ 68 H	N3.2 ■ 40 I	N3.3 ■ 20 G	N4.1 ■ 36 J	N4.2 ■ 34 H	N4.3 ■ 17 F	S1.1 ■ 29 F	S1.2 ■ 16 D	S1.3 ■ 8 B	S2.1 ■ 8 E	S2.2 ■ 7 A	S3.1 ■ 6 E	S3.2 ■ 5 A
S4.1 ■ 5 E	S4.2 ■ 4 A												

Produkt	DC	DC	SDL_1	OAL	DC ON MS
	(mm)	(inch)			
A2061.0X3.15	1.00	0.0394	1.7 - 1.3	31.0	3.15
A2061.25X3.15	1.25	0.0492	2.0 - 1.6	31.0	3.15
A2061.6X4.0	1.60	0.0630	2.6 - 2.0	35.0	4.00
A2062.0X5.0	2.00	0.0787	3.1 - 2.5	40.0	5.00
A2062.5X6.3	2.50	0.0984	3.8 - 3.1	45.0	6.30
A2063.15X8.0	3.15	0.1240	4.6 - 3.9	50.0	8.00
A2064.0X10.0	4.00	0.1575	5.9 - 5.0	55.0	10.00
A2065.0X12.5	5.00	0.1969	7.2 - 6.3	63.0	12.50



A266



HSS Navrtávák, 118° vrcholový úhel, 60° zahloubení, Povlakovaný TiAlN

Doporučen pro navrtání přesného otvoru na koncích hřídelí pro bezpečné upnutí před obráběním. Dva vrtací konce nástroje zvyšují životnost nástroje. Povlak TiAlN pro vyšší produktivitu a delší životnost. Vhodný pro širokou oblast obráběných materiálů.

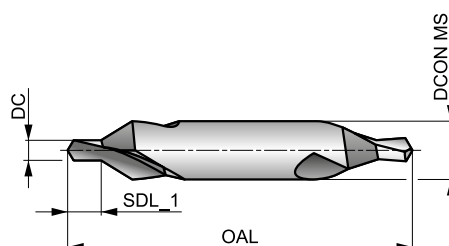

HSS-E	DIN 333A	1xD
60°	TiAlN	
R	118°	

Skupiny obráběných materiálů, startovní řezná rychlost (Vc m/min) a kód posuvu. Tabulku s posuvem na otáčku naleznete od strany 175.

P1.1 ■ 40 I	P1.2 ■ 45 I	P1.3 ■ 46 I	P2.1 ■ 34 I	P2.2 ■ 30 G	P2.3 ■ 27 E	P3.1 ■ 24 F	P3.2 ■ 19 F	P3.3 ■ 16 E	P4.1 ■ 14 F	P4.2 ■ 12 E	P4.3 ■ 10 D	M1.1 ■ 25 E	M1.2 ■ 21 E
M2.1 ■ 22 E	M2.2 ■ 18 E	M3.1 ■ 12 G	M3.2 ■ 10 G	M3.3 ■ 9 G	M4.1 ■ 12 C	K1.1 ■ 36 I	K1.2 ■ 27 F	K1.3 ■ 20 F	K2.1 ■ 30 E	K2.2 ■ 24 E	K2.3 ■ 19 E	K3.1 ■ 26 E	K3.2 ■ 20 E
K3.3 ■ 16 E	K4.1 ■ 24 E	K4.2 ■ 18 E	K4.3 ■ 13 E	K4.4 ■ 11 E	K4.5 ■ 10 E	K5.1 ■ 27 E	K5.2 ■ 21 E	K5.3 ■ 16 E	N1.1 ■ 40 J	N1.2 ■ 30 J	N1.3 ■ 20 I	N2.1 ■ 49 H	N2.2 ■ 44 H
N2.3 ■ 32 H	N3.1 ■ 68 H	N3.2 ■ 40 I	N3.3 ■ 20 G	N4.1 ■ 36 J	N4.2 ■ 34 H	N4.3 ■ 17 F	S1.1 ■ 29 F	S1.2 ■ 16 D	S1.3 ■ 8 B	S2.1 ■ 8 E	S2.2 ■ 7 A	S3.1 ■ 6 E	S3.2 ■ 5 A
S4.1 ■ 5 E	S4.2 ■ 4 A												

Produkt	DC	DC	SDL_1	OAL	DCON MS
	(mm)	(inch)			
A2661.0X3.15	1.00	0.0394	1.7 - 1.3	31.0	3.15
A2661.25X3.15	1.25	0.0492	2.0 - 1.6	31.0	3.15
A2661.6X4.0	1.60	0.0630	2.6 - 2.0	35.0	4.00
A2662.0X5.0	2.00	0.0787	3.1 - 2.5	40.0	5.00
A2662.5X6.3	2.50	0.0984	3.8 - 3.1	45.0	6.30
A2663.15X8.0	3.15	0.1240	4.6 - 3.9	50.0	8.00
A2664.0X10.0	4.00	0.1575	5.9 - 5.0	55.0	10.00
A2665.0X12.5	5.00	0.1969	7.2 - 6.3	63.0	12.50



A210

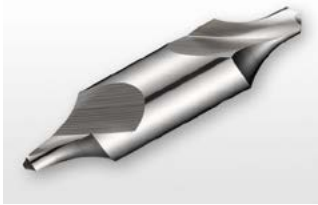

HSS Navrtávák, 118° vrcholový úhel, konkávní zahloubení, Leštěný

Doporučen pro navrtání přesného otvoru na koncích hřídelí pro bezpečné upnutí před obráběním. Dva vrtací konce nástroje zvyšují životnost nástroje. Vhodný pro širokou oblast obráběných materiálů.

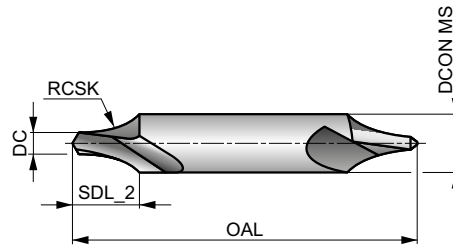

HSS	DIN 333R	1×D
R	Bright	
R	118°	

Skupiny obráběných materiálů, startovní řezná rychlost (Vc m/min) a kód posuvu. Tabulku s posuvem na otáčku naleznete od strany 175.

P1.1 ■ 33 I	P1.2 ■ 37 I	P1.3 ■ 38 I	P2.1 ■ 28 I	P2.2 ■ 25 G	P2.3 ■ 22 E	P3.1 ■ 19 F	P3.2 ■ 15 F	P3.3 ■ 13 E	P4.1 ■ 11 F	P4.2 ■ 10 E	P4.3 ■ 8 D	M1.1 ■ 21 E	M1.2 ■ 17 E
M2.1 ■ 18 E	M2.2 ■ 15 E	M3.1 ■ 9 G	M3.2 ■ 8 G	M3.3 ■ 7 G	M4.1 ■ 10 C	K1.1 ■ 30 I	K1.2 ■ 22 F	K1.3 ■ 17 F	K2.1 ■ 25 E	K2.2 ■ 20 E	K2.3 ■ 16 E	K3.1 ■ 22 E	K3.2 ■ 17 E
K3.3 ■ 13 E	K4.1 ■ 20 E	K4.2 ■ 15 E	K4.3 ■ 11 E	K4.4 ■ 10 E	K4.5 ■ 8 E	K5.1 ■ 23 E	K5.2 ■ 17 E	K5.3 ■ 13 E	N1.1 ■ 33 J	N1.2 ■ 25 J	N1.3 ■ 17 I	N2.1 ■ 42 H	N2.2 ■ 37 H
N2.3 ■ 27 H	N3.1 ■ 56 H	N3.2 ■ 33 I	N3.3 ■ 17 G	N4.1 ■ 30 J	N4.2 ■ 28 H	N4.3 ■ 14 F	S1.1 ■ 24 F	S1.2 ■ 13 D	S1.3 ■ 7 B	S2.1 ■ 7 E	S2.2 ■ 6 A	S3.1 ■ 5 E	S3.2 ■ 4 A
S4.1 ■ 4 E	S4.2 ■ 3 A												

Produkt	DC	DC	SDL_2	OAL	RCSK	DCON MS
	(mm)	(inch)	(mm)	(mm)	(mm)	(mm)
A210.5X3.15 ¹⁾	0.50	0.0197	2.6 - 2.3	25.0	2.50 - 2.00	3.15
A210.8X3.15 ¹⁾	0.80	0.0315	2.9 - 2.6	25.0	3.15 - 2.50	3.15
A2101.0X3.15	1.00	0.0394	3.3 - 3.0	31.0	3.65 - 2.90	3.15
A2101.25X3.15	1.25	0.0492	3.6 - 3.3	31.0	3.95 - 3.15	3.15
A2101.6X4.0	1.60	0.0630	4.7 - 4.2	35.0	5.00 - 4.00	4.00
A2102.0X5.0	2.00	0.0787	5.4 - 5.0	40.0	6.25 - 5.00	5.00
A2102.5X6.3	2.50	0.0984	6.8 - 6.3	45.0	7.88 - 6.30	6.30
A2103.15X8.0	3.15	0.1240	8.5 - 8.0	50.0	10.00 - 8.00	8.00
A2104.0X10.0	4.00	0.1575	10.6 - 10.0	55.0	12.50 - 10.00	10.00
A2105.0X12.5	5.00	0.1969	13.1 - 12.5	63.0	15.63 - 12.50	12.50
A2106.3X16.0	6.30	0.2480	16.6 - 16.0	71.0	20.00 - 16.00	16.00
A2108.0X20.0	8.00	0.3150	20.7 - 20.0	80.0	25.00 - 20.00	20.00
A21010.0X25.0	10.00	0.3937	25.7 - 25.0	100.0	31.25 - 25.00	25.00

¹⁾ Vhodný pro průchozí otvory.



A201

DORMER

HSS Navrtávák, 122° vrcholový úhel, 60° zahloubení, Leštěný

Doporučen pro navrtání přesného otvoru na koncích hřídelí pro bezpečné upnutí před obráběním. Dva vrtací konce nástroje zvyšují životnost nástroje. Vhodný pro širokou oblast obráběných materiálů.

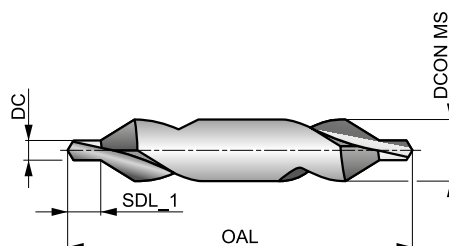

HSS	DORMER	1xD
60°	Bright	
R	122°	

Skupiny obráběných materiálů, startovní řezná rychlost (Vc m/min) a kód posuvu. Tabulku s posuvem na otáčku naleznete od strany 175.

P1.1 ■ 33 I	P1.2 ■ 37 I	P1.3 ■ 38 I	P2.1 ■ 28 I	P2.2 ■ 25 G	P2.3 ■ 22 E	P3.1 ■ 19 F	P3.2 ■ 15 F	P3.3 ■ 13 E	P4.1 ■ 11 F	P4.2 ■ 10 E	P4.3 ■ 8 D	M1.1 ■ 21 E	M1.2 ■ 17 E
M2.1 ■ 18 E	M2.2 ■ 15 E	M3.1 ■ 9 G	M3.2 ■ 8 G	M3.3 ■ 7 G	M4.1 ■ 10 C	K1.1 ■ 30 I	K1.2 ■ 22 F	K1.3 ■ 17 F	K2.1 ■ 25 E	K2.2 ■ 20 E	K2.3 ■ 16 E	K3.1 ■ 22 E	K3.2 ■ 17 E
K3.3 ■ 13 E	K4.1 ■ 20 E	K4.2 ■ 15 E	K4.3 ■ 11 E	K4.4 ■ 10 E	K4.5 ■ 8 E	K5.1 ■ 23 E	K5.2 ■ 17 E	K5.3 ■ 13 E	N1.1 ■ 33 J	N1.2 ■ 25 J	N1.3 ■ 17 I	N2.1 ■ 42 H	N2.2 ■ 37 H
N2.3 ■ 27 H	N3.1 ■ 56 H	N3.2 ■ 33 I	N3.3 ■ 17 G	N4.1 ■ 30 J	N4.2 ■ 28 H	N4.3 ■ 14 F	S1.1 ■ 24 F	S1.2 ■ 13 D	S1.3 ■ 7 B	S2.1 ■ 7 E	S2.2 ■ 6 A	S3.1 ■ 5 E	S3.2 ■ 4 A
S4.1 ■ 4 E	S4.2 ■ 3 A												

Produkt	DC	DC	SDL_1	OAL	DCON MS
	(mm)	(inch)	(mm)	(mm)	(mm)
A201.63X3.15 ¹⁾	0.63	0.0248	1.2 - 0.9	20.0	3.15
A201.75X3.5	0.75	0.0295	1.3 - 1.0	35.0	3.50
A2011.0X4.0	1.00	0.0394	2.1 - 1.5	35.0	4.00
A2011.5X5.0	1.50	0.0591	2.8 - 2.0	40.0	5.00
A2011.6X5.0	1.60	0.0630	2.4 - 2.0	40.0	5.00
A2012.0X6.0	2.00	0.0787	4.0 - 3.0	45.0	6.00
A2012.0X6.3	2.00	0.0787	2.9 - 2.5	45.0	6.30
A2012.5X8.0	2.50	0.0984	4.5 - 3.5	50.0	8.00
A2013.0X8.0	3.00	0.1181	4.4 - 3.9	50.0	8.00
A2013.0X10.0	3.00	0.1181	5.0 - 4.0	56.0	10.00
A2013.15X10.0	3.15	0.1240	4.4 - 3.9	56.0	10.00
A2014.0X12.0	4.00	0.1575	6.2 - 5.0	66.0	12.00
A2015.0X14.0	5.00	0.1969	7.7 - 6.5	78.0	14.00
A2016.0X18.0	6.00	0.2362	9.2 - 8.0	90.0	18.00

¹⁾ Vhodný pro průchozí otvory.



A225

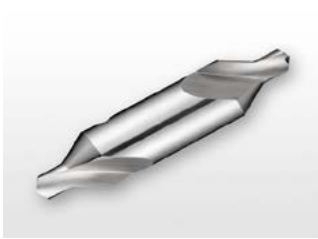

HSS-E Navrtávák, 120° vrcholový úhel, 60° zahloubení, Leštěný

Doporučen pro navrtání přesného otvoru na koncích hřídelí pro bezpečné upnutí před obráběním. Dva vrtací konce nástroje zvyšují životnost nástroje. Vhodný pro širokou oblast obráběných materiálů.

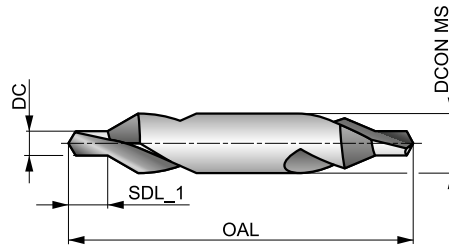

HSS	BS 328	1×D
60°	Bright	
R	120°	

Skupiny obráběných materiálů, startovní řezná rychlost (Vc m/min) a kód posuvu. Tabulku s posuvem na otáčku naleznete od strany 175.

P1.1 ■ 33 I	P1.2 ■ 37 I	P1.3 ■ 38 I	P2.1 ■ 28 I	P2.2 ■ 25 G	P2.3 ■ 22 E	P3.1 ■ 19 F	P3.2 ■ 15 F	P3.3 ■ 13 E	P4.1 ■ 11 F	P4.2 ■ 10 E	P4.3 ■ 8 D	M1.1 ■ 21 E	M1.2 ■ 17 E
M2.1 ■ 18 E	M2.2 ■ 15 E	M3.1 ■ 9 G	M3.2 ■ 8 G	M3.3 ■ 7 G	M4.1 ■ 10 C	K1.1 ■ 30 I	K1.2 ■ 22 F	K1.3 ■ 17 F	K2.1 ■ 25 E	K2.2 ■ 20 E	K2.3 ■ 16 E	K3.1 ■ 22 E	K3.2 ■ 17 E
K3.3 ■ 13 E	K4.1 ■ 20 E	K4.2 ■ 15 E	K4.3 ■ 11 E	K4.4 ■ 10 E	K4.5 ■ 8 E	K5.1 ■ 23 E	K5.2 ■ 17 E	K5.3 ■ 13 E	N1.1 ■ 33 J	N1.2 ■ 25 J	N1.3 ■ 17 I	N2.1 ■ 42 H	N2.2 ■ 37 H
N2.3 ■ 27 H	N3.1 ■ 56 H	N3.2 ■ 33 I	N3.3 ■ 17 G	N4.1 ■ 30 J	N4.2 ■ 28 H	N4.3 ■ 14 F	S1.1 ■ 24 F	S1.2 ■ 13 D	S1.3 ■ 7 B	S2.1 ■ 7 E	S2.2 ■ 6 A	S3.1 ■ 5 E	S3.2 ■ 4 A
S4.1 ■ 4 E	S4.2 ■ 3 A												

Produkty nabízíme i v sadě. Vyhledejte A296.

Produkt	Nr.	DC (inch)	DC (inch)	SDL_1 (inch)	OAL (inch)	DCONMS (inch)
A225BS1	BS1	3/64	0.0469	5/64 - 1/16	1.1/2	1/8
A225BS2	BS2	1/16	0.0625	3/32 - 5/64	1.3/4	3/16
A225BS3	BS3	3/32	0.0938	5/32 - 1/8	2"	1/4
A225BS4	BS4	1/8	0.1250	3/16 - 5/32	2.1/4	5/16
A225BS5	BS5	3/16	0.1875	9/32 - 1/4	2.1/2	7/16
A225BS5A	BSSA	7/32	0.2188	5/16 - 9/32	2.3/4	1/2
A225BS6	BS6	1/4	0.2500	3/8 - 5/16	3"	5/8
A225BS7	BS7	5/16	0.3125	15/32 - 13/32	3.1/2	3/4



A237



HSS-E (5 % kobaltu) Navrtávák, 118° vrcholový úhel, 60° zahloubení, Leštěný

Konstruován pro navrtání přesného otvoru na koncích hřídelí pro podepření hrotem. Dva vrtací konce nástroje zvyšují životnost nástroje. Leštěný povrch. Vhodný pro širokou oblast obráběných materiálů.

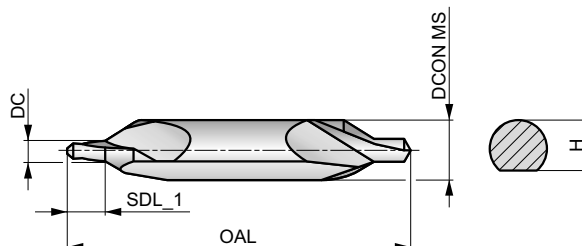

HSS-E	DIN 333A	1xD
60°	Bright	H
R	118°	

Skupiny obráběných materiálů, startovní řezná rychlost (Vc m/min) a kód posuvu. Tabulku s posuvem na otáčku naleznete od strany 175.

P1.1 ■ 33 I	P1.2 ■ 37 I	P1.3 ■ 38 I	P2.1 ■ 28 I	P2.2 ■ 25 G	P2.3 ■ 22 E	P3.1 ■ 19 F	P3.2 ■ 15 F	P3.3 ■ 13 E	P4.1 ■ 11 F	P4.2 ■ 10 E	P4.3 ■ 8 D	M1.1 ■ 21 E	M1.2 ■ 17 E
M2.1 ■ 18 E	M2.2 ■ 15 E	M3.1 ■ 9 G	M3.2 ■ 8 G	M3.3 ■ 7 G	M4.1 ■ 10 C	K1.1 ■ 30 I	K1.2 ■ 22 F	K1.3 ■ 17 F	K2.1 ■ 25 E	K2.2 ■ 20 E	K2.3 ■ 16 E	K3.1 ■ 22 E	K3.2 ■ 17 E
K3.3 ■ 13 E	K4.1 ■ 20 E	K4.2 ■ 15 E	K4.3 ■ 11 E	K4.4 ■ 10 E	K4.5 ■ 8 E	K5.1 ■ 23 E	K5.2 ■ 17 E	K5.3 ■ 13 E	N1.1 ■ 33 J	N1.2 ■ 25 J	N1.3 ■ 17 I	N2.1 ■ 42 H	N2.2 ■ 37 H
N2.3 ■ 27 H	N3.1 ■ 56 H	N3.2 ■ 33 I	N3.3 ■ 17 G	N4.1 ■ 30 J	N4.2 ■ 28 H	N4.3 ■ 14 F	S1.1 ■ 24 F	S1.2 ■ 13 D	S1.3 ■ 7 B	S2.1 ■ 7 E	S2.2 ■ 6 A	S3.1 ■ 5 E	S3.2 ■ 4 A
S4.1 ■ 4 E	S4.2 ■ 3 A												

Produkt	DC	DC	SDL_1	OAL	DC ON MS	H
	(mm)	(inch)	(mm)	(mm)	(mm)	(mm)
A2371.6X4.0	1.60	0.0630	2.6 - 2.0	35.0	4.00	3.25 - 3.15
A2372.0X5.0	2.00	0.0787	3.1 - 2.5	40.0	5.00	4.20 - 4.10
A2372.5X6.3	2.50	0.0984	3.8 - 3.1	45.0	6.30	5.35 - 5.25
A2373.15X8.0	3.15	0.1240	4.6 - 3.9	50.0	8.00	6.95 - 6.85
A2374.0X10.0	4.00	0.1575	5.9 - 5.0	55.0	10.00	8.40 - 8.30
A2375.0X12.5	5.00	0.1969	7.2 - 6.3	63.0	12.50	10.95 - 10.85
A2376.3X16.0	6.30	0.2480	8.9 - 8.0	71.0	16.00	14.00 - 13.90
A2378.0X20.0	8.00	0.3150	11.1 - 10.1	80.0	20.00	17.90 - 17.80
A23710.0X25.0	10.00	0.3937	13.8 - 12.8	100.0	25.00	22.50 - 22.40



A238



HSS-E (5 % kobaltu) Navrtávák, 118° vrcholový úhel, Stopka s ploškou, Leštěný

Konstruován pro navrtání přesného otvoru na koncích hřídelí pro podepření hrotem. Dva vrtací konce nástroje zvyšují životnost nástroje. Leštěný povrch. Vhodný pro širokou oblast obráběných materiálů.

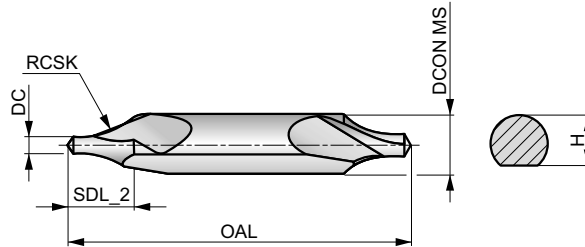

HSS-E	DIN 333R	1xD
R	Bright	H
R	118°	

Skupiny obráběných materiálů, startovní řezná rychlost (Vc m/min) a kód posuvu. Tabulku s posuvem na otáčku naleznete od strany 175.

P1.1 ■ 33 I	P1.2 ■ 37 I	P1.3 ■ 38 I	P2.1 ■ 28 I	P2.2 ■ 25 G	P2.3 ■ 22 E	P3.1 ■ 19 F	P3.2 ■ 15 F	P3.3 ■ 13 E	P4.1 ■ 11 F	P4.2 ■ 10 E	P4.3 ■ 8 D	M1.1 ■ 21 E	M1.2 ■ 17 E
M2.1 ■ 18 E	M2.2 ■ 15 E	M3.1 ■ 9 G	M3.2 ■ 8 G	M3.3 ■ 7 G	M4.1 ■ 10 C	K1.1 ■ 30 I	K1.2 ■ 22 F	K1.3 ■ 17 F	K2.1 ■ 25 E	K2.2 ■ 20 E	K2.3 ■ 16 E	K3.1 ■ 22 E	K3.2 ■ 17 E
K3.3 ■ 13 E	K4.1 ■ 20 E	K4.2 ■ 15 E	K4.3 ■ 11 E	K4.4 ■ 10 E	K4.5 ■ 8 E	K5.1 ■ 23 E	K5.2 ■ 17 E	K5.3 ■ 13 E	N1.1 ■ 33 J	N1.2 ■ 25 J	N1.3 ■ 17 I	N2.1 ■ 42 H	N2.2 ■ 37 H
N2.3 ■ 27 H	N3.1 ■ 56 H	N3.2 ■ 33 I	N3.3 ■ 17 G	N4.1 ■ 30 J	N4.2 ■ 28 H	N4.3 ■ 14 F	S1.1 ■ 24 F	S1.2 ■ 13 D	S1.3 ■ 7 B	S2.1 ■ 7 E	S2.2 ■ 6 A	S3.1 ■ 5 E	S3.2 ■ 4 A
S4.1 ■ 4 E	S4.2 ■ 3 A												

Produkt	DC	DC	SDL_2	OAL	RCSR	DCON MS	H
	(mm)	(inch)	(mm)	(mm)	(mm)	(mm)	(mm)
A2381.6X4.0	1.60	0.0630	4.7 - 4.2	35.0	5.00 - 4.00	4.00	3.25 - 3.15
A2382.0X5.0	2.00	0.0787	5.4 - 5.0	40.0	6.25 - 5.00	5.00	4.20 - 4.10
A2382.5X6.3	2.50	0.0984	6.8 - 6.3	45.0	7.88 - 6.30	6.30	5.35 - 5.25
A2383.15X8.0	3.15	0.1240	8.5 - 8.0	50.0	10.00 - 8.00	8.00	6.95 - 6.85
A2384.0X10.0	4.00	0.1575	10.6 - 10.0	55.0	12.50 - 10.00	10.00	8.40 - 8.30
A2385.0X12.5	5.00	0.1969	13.1 - 12.5	63.0	15.63 - 12.50	12.50	10.95 - 10.85
A2386.3X16.0	6.30	0.2480	16.6 - 16.0	71.0	20.00 - 16.00	16.00	14.00 - 13.90
A2388.0X20.0	8.00	0.3150	20.7 - 20.0	80.0	25.00 - 20.00	20.00	17.90 - 17.80



A242

DORMER

HSS-E (5 % kobaltu) Navrtávák, Prodloužená varianta, 118° vrcholový úhel, 60° zahloubení, Leštěný
 Konstruován pro navrtání přesného otvoru na koncích hřídelí pro podepření hrotem. Dva vrtací konce nástroje zvyšují životnost nástroje. Leštěný povrch. Vhodný pro širokou oblast obráběných materiálů.

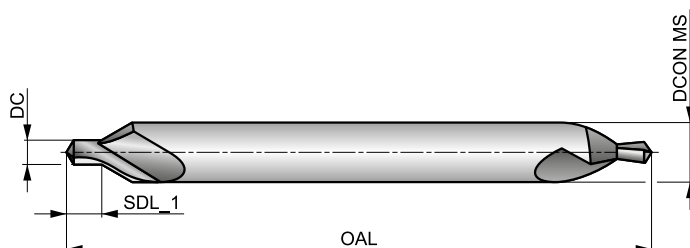

HSS-E		1xD
60°	Bright	
R	118°	

Skupiny obráběných materiálů, startovní řezná rychlost (Vc m/min) a kód posuvu. Tabulku s posuvem na otáčku naleznete od strany 175.

P1.1 ■ 33 I	P1.2 ■ 37 I	P1.3 ■ 38 I	P2.1 ■ 28 I	P2.2 ■ 25 G	P2.3 ■ 22 E	P3.1 ■ 19 F	P3.2 ■ 15 F	P3.3 ■ 13 E	P4.1 ■ 11 F	P4.2 ■ 10 E	P4.3 ■ 8 D	M1.1 ■ 21 E	M1.2 ■ 17 E
M2.1 ■ 18 E	M2.2 ■ 15 E	M3.1 ■ 9 G	M3.2 ■ 8 G	M3.3 ■ 7 G	M4.1 ■ 10 C	K1.1 ■ 30 I	K1.2 ■ 22 F	K1.3 ■ 17 F	K2.1 ■ 25 E	K2.2 ■ 20 E	K2.3 ■ 16 E	K3.1 ■ 22 E	K3.2 ■ 17 E
K3.3 ■ 13 E	K4.1 ■ 20 E	K4.2 ■ 15 E	K4.3 ■ 11 E	K4.4 ■ 10 E	K4.5 ■ 8 E	K5.1 ■ 23 E	K5.2 ■ 17 E	K5.3 ■ 13 E	N1.1 ■ 33 J	N1.2 ■ 25 J	N1.3 ■ 17 I	N2.1 ■ 42 H	N2.2 ■ 37 H
N2.3 ■ 27 H	N3.1 ■ 56 H	N3.2 ■ 33 I	N3.3 ■ 17 G	N4.1 ■ 30 J	N4.2 ■ 28 H	N4.3 ■ 14 F	S1.1 ■ 24 F	S1.2 ■ 13 D	S1.3 ■ 7 B	S2.1 ■ 7 E	S2.2 ■ 6 A	S3.1 ■ 5 E	S3.2 ■ 4 A
S4.1 ■ 4 E	S4.2 ■ 3 A												

Produkt	DC	DC	SDL_1	OAL	DCON MS
	(mm)	(inch)	(mm)	(mm)	(mm)
A2421.0X4.0	1.00	0.0394	1.7 - 1.3	100.0	4.00
A2421.5X5.0	1.50	0.0591	2.6 - 2.0	100.0	5.00
A2422.0X6.0	2.00	0.0787	3.1 - 2.5	100.0	6.00
A2422.5X8.0	2.50	0.0984	3.8 - 3.1	100.0	8.00
A2423.0X8.0	3.00	0.1181	4.6 - 3.9	100.0	8.00
A2423.0X10.0	3.00	0.1181	4.6 - 3.9	100.0	10.00
A2424.0X10.0	4.00	0.1575	5.9 - 5.0	100.0	10.00
A2424.0X12.0	4.00	0.1575	5.9 - 5.0	100.0	12.00
A2425.0X12.0	5.00	0.1969	7.2 - 6.3	100.0	12.00



A088

DORMER



Sada HSS navrtávků A022, Povlak TiN-Tip

Sada obsahuje 24 rozměrových variant navrtávků A022 v boxu. Navrtávky jsou vhodné pro ruční i strojní vrtání. Povlak TiN zlepšuje výkon a zvyšuje životnost.

HSS	DIN ANSI	2.5xD
135°	TiN-Tip	
20-35°	R	DC h8

A = typy v sadě, B = počet v sadě, C = rozměry v sadě.

Produkt	Nr.	A	B	C
A0882005	2005	A022	24	1.0 mm - 10.5 mm x 0.5 mm + 3.3 mm, 4.2 mm, 6.8 mm, 10.2 mm

A095

DORMER



Sada HSS vrtáků A002, Povlakovaných TiN-Tip

Různé sady vrtáků A002 v metrické i palcové řadě uložené v praktickém plastovém boxu, kde jsou velikosti vrtáků čitelně označeny pro snadnou volbu. Vrtáky vhodné pro strojní i ruční vrtání. Povlak TiN zlepšuje výkon a prodlužuje životnost.

HSS	DIN 338	4xD
118°	TiN-Tip	
20-35°	R	DC h8

1,0 mm =< DC >= 2,9 mm 118° - 4 fasetkový vrchol. A = typy v sadě, B = počet v sadě, C = rozměry v sadě.

Produkt	Nr.	A	B	C
A09518	18	A002	29	1/16 inch - 1/2 inch x 1/64 inch
A09520	20	A002	15	1/16 inch - 1/2 inch x 1/32 inch
A095200	200	A002	24	1.0 mm - 10.5 mm x 0.5 mm + 3.3 mm, 4.2 mm, 6.8 mm, 10.2 mm
A095201	201	A002	19	1.0 mm - 10.0 mm x 0.5 mm
A095202	202	A002	51	1.0 mm - 6.0 mm x 0.1 mm
A095203	203	A002	41	6.0 mm - 10.0 mm x 0.1 mm
A095204	204	A002	25	1.0 mm - 13.0 mm x 0.5 mm
A095206	206	A002	29	1.0 mm - 13.0 mm x 0.5 mm + 3.3 mm, 4.2 mm, 6.8 mm, 10.2 mm
A095209	209	A002	91	1.0 mm - 10.0 mm x 0.1 mm



A087

DORMER



Sada HSS vrtáků A002, Povlak TiN-Tip

Sada obsahuje 19 rozměrových variant vrtáků A002 v boxu s označením rozměrů vrtáků pro snadnou volbu. Vrtáky jsou vhodné pro ruční i strojní vrtání. Povlak TiN zlepšuje výkon a zvyšuje životnost.

HSS	DIN 338	4xD
118°		
λ20-35°		DC h8

A = typy v sadě, B = počet v sadě, C = rozměry v sadě. 1,0 mm =< DC >= 2,9 mm 118° - 4 fasetkový vrchol.

Produkt	Nr.	A	B	C
A087201	201	A002	19	1.0 mm - 10.0 mm x 0.5 mm

A094

DORMER



Sada HSS vrtáků A002, Povlak TiN-Tip

Sada obsahuje rozměrové varianty vrtáků A002 v metrické řadě. Vrtáky jsou umístěny v kruhovém boxu pro snadnou volbu.

HSS	DIN 338	4xD
118°		
λ20-35°		DC h8

A = typy v sadě, B = počet v sadě, C = rozměry v sadě. 1,0 mm =< DC >= 2,9 mm 118° - 4 fasetkový vrchol.

Produkt	Nr.	A	B	C
A094413	413	A002	13	1.5 mm - 6.5 mm x 0.5 mm + 3.3 mm, 4.2 mm
A094419	419	A002	19	1.0 mm - 10.0 mm x 0.5 mm



A089



Sada HSS vrtáků A002, Povlak TiN-Tip

Sada obsahuje 5 rozměrových variant vrtáků A002 v ručním boxu. Vrtáky jsou vhodné pro ruční i strojní vrtání. Povlak TiN zlepšuje výkon a zvyšuje životnost.

HSS	DIN 338	4xD
118°	TiN-Tip	
20-35°	R	DC h8

A = typy v sadě, B = počet v sadě, C = rozměry v sadě.

Produkt	Nr.	A	B	C
A08910	10	A002	5	A0024.0, A0025.0, A0026.0, A0028.0, A00210.0

**A099****DORMER****Příhradkový pořadač s vrtáky A002, Povlakované TiN-Tip**

Volně stojící příhradkový pořadač s širokou rozměrovou řadou vrtáků A002. Vhodný k umístění na pracovním stole nebo jiné vhodné ploše. Nabízí přehledný sortiment a snadnou volbu vrtáků.

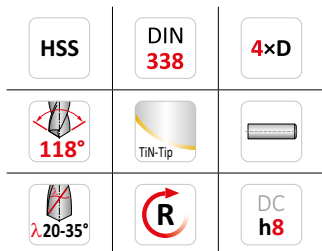

1,0mm =< DC >= 2,9mm 118° - 4 fasetkový vrchol. A = typy v sadě, B = počet v sadě, C = rozměry v sadě.

Produkt	Nr.	A	B	C
A099F1	F1	A002	380	5 x (13/32, 7/16, 15/32, 1/2) inch; 10 x (5/64, 7/64, 9/64, 11/64, 13/64, 15/64, 17/64, 9/32, 19/64, 5/16, 21/64, 11/32, 23/64, 3/8) inch; 20 x (1/16, 7/32, 1/4) inch; 30 x 3/32 inch; 40 x (5/32, 3/16) inch; 50 x 1/8 inch
A099M1	M1	A002	340	5 x (10.50, 11.00, 11.50, 12.00, 12.50, 13.00) mm; 10 x (1.50, 2.50, 3.50, 4.50, 5.50, 6.50, 7.00, 7.50, 8.00, 8.50, 9.00, 9.50, 10.00) mm; 20 x (1.00, 5.00, 6.00) mm; 30 x 2.00 mm; 40 x 4.00 mm; 50 x 3.00 mm

A099**DORMER****Pořadač s řadou vrtáků A002, Povlakované TiN-Tip**

Volně stojící pořadač Drillboy s širokou rozměrovou řadou vrtáků A002. Vhodný k umístění na pracovním stole nebo jiné vhodné ploše. Nabízí přehledný sortiment a snadnou volbu vrtáků.

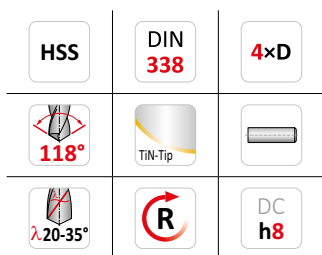

1,0mm =< DC >= 2,9mm 118° - 4 fasetkový vrchol. A = typy v sadě, B = počet v sadě, C = rozměry v sadě.

Produkt	Nr.	A	B	C
A099DRILLBOY	DRILLBOY	A002	43	3 x (3.0 mm, 3.3 mm, 3.5 mm, 4.0 mm) + 2 x (4.2 mm, 4.5 mm, 5.0 mm, 5.5 mm, 6.0 mm, 6.5 mm, 6.8 mm, 7.0 mm, 7.5 mm, 8.0 mm) + 8.5 mm, 9.0 mm, 9.5 mm, 10.0 mm, 10.2 mm, 10.5 mm, 11.0 mm, 11.5 mm, 12.0 mm, 12.5 mm, 13.0 mm



A199

DORMER



Příhradkový pořadač s HSS vrtáky A100

Volně stojící příhradkový pořadač s širokou rozměrovou řadou vrtáků A100. Vhodný k umístění na pracovním stole nebo jiné vhodné ploše. Nabízí přehledný sortiment a snadnou volbu vrtáků.

HSS	DIN 338	4xD
118°	ST	
20-35°		DC h8

A = typy v sadě, B = počet v sadě, C = rozměry v sadě.

Produkt	Nr.	A	B	C
A199F1	F1	A100	380	5 x (13/32, 7/16, 15/32, 1/2) inch; 10 x (5/64, 7/64, 9/64, 11/64, 13/64, 15/64, 17/64, 9/32, 19/64, 5/16, 21/64, 11/32, 23/64, 3/8) inch; 20 x (1/16, 7/32, 1/4) inch; 30 x 3/32 inch; 40 x (5/32, 3/16) inch; 50 x 1/8 inch
A199M1	M1	A100	340	5 x (10.50, 11.00, 11.50, 12.00, 12.50, 13.00) mm; 10 x (1.50, 2.50, 3.50, 4.50, 5.50, 6.50, 7.00, 7.50, 8.00, 8.50, 9.00, 9.50, 10.00) mm; 20 x (1.00, 5.00, 6.00) mm; 30 x 2.00 mm; 40 x 4.00 mm; 50 x 3.00mm

A080

DORMER



Prázdný příhradkový pořadač

Pořadač je nabízen prázdný pro možnost zakoupení vrtáků v požadovaném množství. Je dodáván s logem Dormer a zobrazením různých vrtáků Dormer. Na třech policích jsou označeny velikosti vrtáků v metrické řadě nebo palcích.

Prázdný zásobník.

Produkt	Nr.	C
A080M1EMPTY	M1EMPTY	(1.00, 1.50, 2.00, 2.50, 3.00, 3.50, 4.00, 4.50, 5.00, 5.50, 6.00, 6.50, 7.00, 7.50, 8.00, 8.50, 9.00, 9.50, 10.00, 10.50, 11.00, 11.50, 12.00) mm
A080F1EMPTY	F1EMPTY	(1/16, 5/64, 3/32, 7/64, 1/8, 9/64, 5/32, 11/64, 3/16, 13/64, 7/32, 15/64, 1/4, 17/64, 9/32, 19/64, 5/16, 21/64, 11/32, 3/8, 13/32, 7/16, 1/2) inch



A190

DORMER



Sada HSS vrtáků A100, Parní temperace povrchu

Sada obsahuje rozměrové varianty vrtáků A100 s vrcholovým úhlem 118° v metrické i palcové řadě. Vrtáky umístěny v praktickém boxu s označením průměrů pro snadný výběr.

HSS	DIN 338	4×D
118°		
λ 20-35°		DC h8

A = typy v sadě, B = počet v sadě, C = rozměry v sadě. DC <= 1 mm; 3/64"; N60 - leštěný.

Produkt	Nr.	A	B	C
A1903	3	A100	21	1/16 inch - 3/8 inch x 1/64 inch
A19012	12	A100	60	No.1 - No.60
A19018	18	A100	29	1/16 inch - 1/2 inch x 1/64 inch
A19020	20	A100	15	1/16 inch - 1/2 inch x 1/32 inch
A190201	201	A100	19	1.0 mm - 10.0 mm x 0.5 mm
A190202	202	A100	51	1.0 mm - 6.0 mm x 0.1 mm
A190203	203	A100	41	6.0 mm - 10.0 mm x 0.1 mm
A190204	204	A100	25	1.0 mm - 13.0 mm x 0.5 mm
A190206	206	A100	29	1.0 mm - 13.0 mm x 0.5 mm + 3.3 mm, 4.2 mm, 6.8 mm, 10.2 mm
A190209 ¹⁾	209	A100	91	1.0 mm - 10.0 mm x 0.1 mm

¹⁾ Prodává se ve 2 krabičkách: krabička 1 obsahuje velikosti (1,0-5,9 x 0,1 mm); krabička 2 obsahuje velikosti (6,0-10,0 x 0,1 mm).



A191

DORMER



Sada HSS vrtáků A100, Parní temperace povrchu

Sada obsahuje rozměrové varianty vrtáků A100 v metrické řadě. Vrtáky jsou umístěny v praktickém boxu s označením průměrů. Vrcholový úhel vrtáků 118°. Dodávány v metrických nebo palcových řadách. V plastovém boxu.

HSS	DIN 338	4xD
118°	ST	
20-35°		DC h8

A = typy v sadě, B = počet v sadě, C = rozměry v sadě. DC <= 1 mm; 3/64"; N60 - leštěný.

Produkt	Nr.	A	B	C
A19131M	31M	A100	20	0.3 mm - 1.0 mm x 0.05 mm + 0.38 mm, 0.52 mm, 0.58 mm, 0.78 mm, 0.82 mm
A19161-80	61-80	A100	20	No.61 - No. 80

A191

DORMER



Sada HSS vrtáků A100, Parní temperace povrchu

Sada obsahuje rozměrové varianty vrtáků A100 v metrické řadě. Vrtáky jsou umístěny v kruhovém boxu pro snadnou volbu.

HSS	DIN 338	4xD
118°	ST	
20-35°		DC h8

A = typy v sadě, B = počet v sadě, C = rozměry v sadě. DC <= 1 mm; 3/64"; N60 - leštěný.

Produkt	Nr.	A	B	C
A191413	413	A100	13	1.5 mm - 6.5 mm x 0.5 mm + 3.3 mm, 4.2 mm
A191419	419	A100	19	1.0 mm - 10.0 mm x 0.5 mm



A188

DORMER



Sada HSS vrtáků A108, Parní temperace povrchu

Sada rozměrových variant vrtáků A108 v praktickém plastovém boxu. Široké použití pro strojní i ruční aplikace.

HSS	DIN 338	4×D
135°		
λ > 35°		DC h8

A = typy v sadě, B = počet v sadě, C = rozměry v sadě. DC > 1,5 mm; 1/16" - s příčným ostřím.

Produkt	Nr.	A	B	C
A188201	201	A108	19	1.0 mm - 10.0 mm x 0.5 mm
A188204	204	A108	25	1.0 mm - 13.0 mm x 0.5 mm

A295

DORMER



Sada HSS-E (8 % kobaltu) vrtáků A777, Povrchová úprava Bronz

Sada rozměrových variant vrtáků A777 v praktickém plastovém boxu. Velikosti vrtáků jsou viditelně označeny pro snadný výběr. Vrtáky A777 mají vrcholový úhel 135°, což napomáhá vystředění vrtáku a redukuje řezné síly.

HSS-E	DIN 338	4×D
135°		
λ 20-35°		DC h8

A = typy v sadě, B = počet v sadě, C = rozměry v sadě. DC ≤ 1,4 mm - 4 fasetkový vrchol.

Produkt	Nr.	A	B	C
A295219	219	A777	19	1.0 mm - 10.0 mm x 0.5 mm
A295225	225	A777	25	1.0 mm - 13.0 mm x 0.5 mm



A296

DORMER



Sada HSS středících navrtávků

Sada 5 středících navrtávků v plastovém boxu. Použití pro přesné navrtávání otvorů v čele hřídelí (pro podepření hrotem). Navrtávky mají bříty na obou koncích pro zvýšení užité hodnoty.

A296200 - 118° hrot DIN333A, A296225 - 120° hrot BS328. A = typy v sadě, B = počet v sadě, C = rozměry v sadě.

Produkt	Nr.	A	B	C
A296200	200	A200	5	1.00 mm, 2.00 mm, 2.50 mm, 3.15 mm, 4.00 mm
A296225	225	A225	5	BS1, BS2, BS3, BS4, BS5

M150

DORMER



Redukční vložka Morse, Tvrzená

Adaptér umožňuje upnutí nástroje s menším Morse kuželem do vřetena či upínače s větším Morse kuželem.

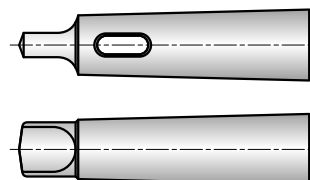

K = vnější Morse kužel; K1 = vnitřní Morse kužel.

Produkt	Nr.	K = Nr.	K1 = Nr.
M1501-0	10	Nr. 1	Nr. 0
M1502-1	21	Nr. 2	Nr. 1
M1503-1	31	Nr. 3	Nr. 1
M1504-1	41	Nr. 4	Nr. 1
M1503-2	32	Nr. 3	Nr. 2
M1504-2	42	Nr. 4	Nr. 2
M1505-2	52	Nr. 5	Nr. 2
M1504-3	43	Nr. 4	Nr. 3
M1505-3	53	Nr. 5	Nr. 3
M1505-4	54	Nr. 5	Nr. 4
M1506-5	65	Nr. 6	Nr. 5



M151

DORMER



Redukční vložka Morse, Kalená a broušená

Adaptér umožňuje upnutí nástroje s menším Morse kuželem do vřetena či upínače s větším Morse kuželem.

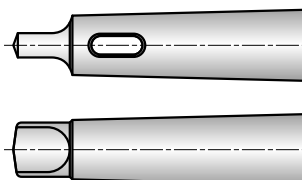

K = vnější Morse kužel; K1 = vnitřní Morse kužel.

Produkt	Nr.	K = Nr.	K1 = Nr.
M1511-0	10	Nr. 1	Nr. 0
M1512-1	21	Nr. 2	Nr. 1
M1513-1	31	Nr. 3	Nr. 1
M1514-1	41	Nr. 4	Nr. 1
M1513-2	32	Nr. 3	Nr. 2
M1514-2	42	Nr. 4	Nr. 2
M1515-2	52	Nr. 5	Nr. 2
M1514-3	43	Nr. 4	Nr. 3
M1515-3	53	Nr. 5	Nr. 3
M1515-4	54	Nr. 5	Nr. 4
M1516-5	65	Nr. 6	Nr. 5

M152

DORMER



Vyrážecí klín

Slouží k vyrážení vrtáků s kuželovou stopkou z vřeten strojů a pouzder s Morse kuželem.



Produkt	Nr.
M1520	Nr. 0
M15212	Nr. 1 + 2
M15234	Nr. 3 + 4
M15245	Nr. 4 + 5
M1526	Nr. 6



TABULKA POSUVŮ PRO VRTÁNÍ

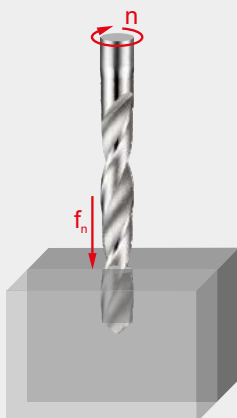

Posuv na otáčku (f_n v mm/ot)
V závislosti na pracovních podmínkách
může být nutné tyto hodnoty upravit
 $\pm 25\%$.

Jak pomocí této tabulky najít posuv na otáčku (f_n):

1. Vyhledejte svůj kód alfa na stránce produktu (například: 46J_nJⁿ je alfa kód).
2. V horním řádku tabulky najdete nejbližší průměr pro vaši řeznou aplikaci.
3. Vyhledejte svůj alfa kód v levém sloupci tabulky.
4. Průsečík (buňka) průměru a alfa kódu je posuv na otáčku (f_n).

		ø DC (mm)																		
		0.15	0.50	1.00	2.00	3.00	4.00	5.00	6.00	8.00	10.00	12.00	15.00	16.00	20.00	25.00	30.00	40.00	50.00	100.00
Posuvy	A	0.003	0.006	0.012	0.023	0.029	0.032	0.036	0.042	0.054	0.062	0.069	0.082	0.086	0.110	0.125	0.135	0.155	0.175	0.263
	B	0.004	0.007	0.014	0.028	0.037	0.041	0.046	0.053	0.067	0.080	0.090	0.103	0.108	0.135	0.153	0.165	0.188	0.208	0.312
	C	0.004	0.008	0.015	0.032	0.044	0.050	0.056	0.064	0.080	0.098	0.110	0.125	0.130	0.160	0.180	0.195	0.220	0.240	0.360
	D	0.004	0.008	0.016	0.038	0.053	0.060	0.068	0.078	0.098	0.119	0.130	0.149	0.155	0.188	0.210	0.228	0.253	0.275	0.413
	E	0.004	0.009	0.017	0.043	0.062	0.071	0.080	0.092	0.115	0.140	0.150	0.173	0.180	0.215	0.240	0.260	0.285	0.310	0.465
	F	0.005	0.009	0.018	0.050	0.073	0.084	0.095	0.109	0.138	0.165	0.178	0.202	0.210	0.248	0.275	0.295	0.320	0.343	0.515
	G	0.005	0.010	0.019	0.056	0.084	0.096	0.109	0.126	0.160	0.190	0.205	0.231	0.240	0.280	0.310	0.330	0.355	0.375	0.563
	H	0.005	0.010	0.020	0.066	0.102	0.116	0.130	0.150	0.190	0.228	0.243	0.271	0.280	0.320	0.355	0.375	0.398	0.418	0.627
	I	0.005	0.011	0.021	0.076	0.119	0.134	0.150	0.173	0.220	0.265	0.280	0.310	0.320	0.360	0.400	0.420	0.440	0.460	0.690
	J	0.006	0.012	0.024	0.084	0.135	0.152	0.170	0.197	0.250	0.298	0.315	0.349	0.360	0.405	0.445	0.465	0.485	0.503	0.755
	K	0.007	0.013	0.026	0.092	0.150	0.170	0.190	0.220	0.280	0.330	0.350	0.388	0.400	0.450	0.490	0.510	0.530	0.545	0.818
	L	0.007	0.014	0.028	0.101	0.165	0.186	0.208	0.240	0.305	0.360	0.385	0.419	0.430	0.485	0.525	0.545	0.568	0.588	0.882
	M	0.008	0.015	0.030	0.110	0.180	0.202	0.225	0.260	0.330	0.390	0.420	0.450	0.460	0.520	0.560	0.580	0.605	0.630	0.945
	N	0.008	0.016	0.032	0.119	0.195	0.218	0.242	0.280	0.355	0.420	0.455	0.481	0.490	0.555	0.595	0.615	0.642	0.672	1.008
	S	0.002	0.004	0.008	0.014	0.020	0.025	0.030	0.037	0.050	0.080	0.100	0.123	0.130	0.150	0.170	0.190	0.220	0.240	–
	T	0.004	0.008	0.015	0.028	0.040	0.050	0.060	0.070	0.090	0.110	0.130	0.160	0.170	0.190	0.210	0.230	0.260	0.275	–
	U	0.007	0.013	0.026	0.048	0.070	0.080	0.090	0.107	0.140	0.170	0.200	0.223	0.230	0.240	0.270	0.300	0.360	0.375	–
	V	0.010	0.019	0.038	0.069	0.100	0.115	0.130	0.153	0.200	0.250	0.280	0.310	0.320	0.340	0.400	0.440	0.510	0.530	–
	W	0.012	0.025	0.049	0.089	0.130	0.150	0.170	0.200	0.260	0.330	0.380	0.418	0.430	0.450	0.470	0.490	0.520	0.540	–
	X	0.014	0.028	0.056	0.103	0.150	0.180	0.210	0.250	0.330	0.420	0.480	0.533	0.550	0.580	–	–	–	–	–
Y	0.017	0.034	0.068	0.124	0.180	0.220	0.260	0.317	0.430	0.550	0.700	0.700	0.700	0.740	–	–	–	–	–	
Z	0.024	0.047	0.094	0.172	0.250	0.325	0.400	0.533	0.800	1.000	1.100	1.175	1.200	1.200	–	–	–	–	–	



VRTÁNÍ
TECHNICKÉ INFORMACE

MONOLITNÍ KARBIDOVÉ A HSS VRTÁKY – TECHNICKÉ INFORMACE

Názvosloví

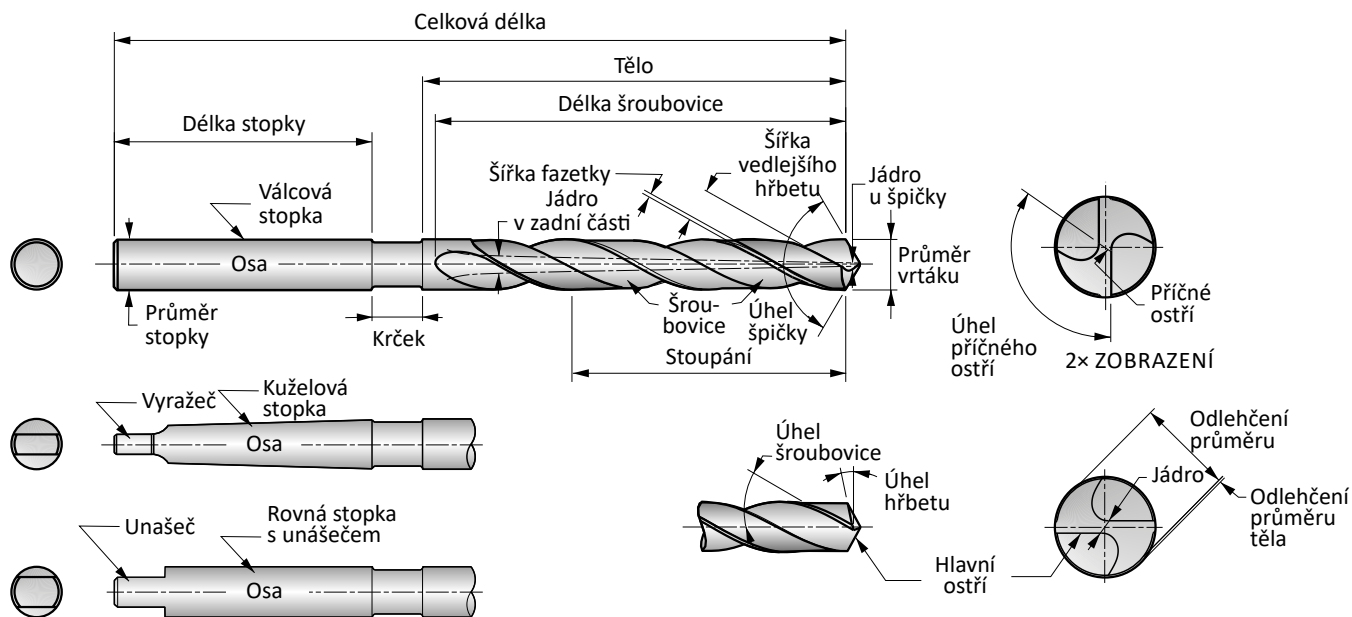

- **Příčné ostří** – nebo také přechodový břit. Čím menší je příčné ostří, tím lepší je tzv. samostředící účinek. Naopak větší přechodový břit zvyšuje mechanickou odolnost nástroje, ale zároveň zvyšuje řezné síly.
- **Délka šroubovice** – celková délka šroubovice. Maximální hloubka vrtání by měla být rovna nebo menší než délka šroubovice minus 1,5 násobek průměru vrtáku.
- **Úhel stoupání šroubovice λ**
 - **Vrták typu H** má malé stoupání šroubovice 10°-20°. Jsou určeny převážně pro plasty a mosaz.
 - **Vrtáky typu N** mají standardní šroubovici 21°-34°. Výsledkem je, že řezný úhel je vhodný pro univerzální vrtání ve většině materiálů.
 - **Vrták typu W** má největší úhel šroubovice 35°-45°, vrták je tak robustnější a efektivnější. Používají k vrtání měkčích a houževnatějších materiálů například nerezové oceli.
- **Celková délka** – Délka vrtáku včetně stopky, krčku a šroubovice.

- **Tvar špičky**
 - **Tvar N** - nejčastěji používaný způsob broušení špičky, protože v kombinaci s vrcholový úhlem 118° je velmi univerzální. Možným omezením je velké příčné ostří, kde pro lepší středění doporučujeme použít středící vrták (navrtávák).

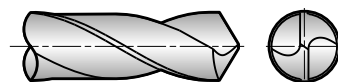

- **Tvar C** - hlavní výhodou jsou nízké řezné síly a tzv. samostředící účinek. To je výhodné např. pro použití v ručních vrtačkách. Dělená špička má rovněž dvě pozitivní řezné hrany, které mohou sloužit jako utvářeč třísek pro jejich snadné odvedení z místa řezu.

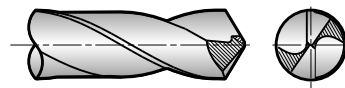



MONOLITNÍ KARBIDOVÉ A HSS VRTÁKY – TECHNICKÉ INFORMACE

- **Tvar A** - tento tvar se používá hlavně pro vrtání houževnatých slitin. Tento výbrus se používá v kombinaci se silným jádrem, aby odolal vyššímu zatížení při vrtání těchto materiálů.

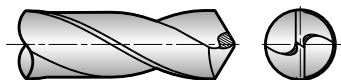

Úhel špičky ϵ - je úhel, který spolu svírají ve špičce obě hlavní ostří

Materiál	Vrcholový úhel ϵ
Ocel, litina	116°-120°
Hliník, měď	125°-140°
Bronz, mosaz	130°-140°
Plast	60°
Plech	180°

Stopka – část vrtáku sloužící pro upnutí

- druhy stopek
 - Kuželová stopka
 - Válcová stopka
 - Válcová stopka s unašečem

Všeobecné pokyny pro vrtání

1. Vyberte vrták, který je na danou aplikaci nejvhodnější, uvažujte o obráběném materiálu, vlastnostech stroje a použití chlazení.
2. Nepřesnosti v sousostí a nestabilita vřetene mohou způsobit zničení vrtáku i obráběné součásti - vždy zajistěte maximální možnou stabilitu. Ta může být vylepšena použitím nejkratšího možného vrtáku pro danou operaci.
3. Upnutí nástroje je při vrtání důležité, vrták nesmí být při vrtání zatlačován ani vytahován z upínače.
4. Upnutí vrtáků s Morse stopkou musí být správně nastaveno. Dosedací plochy musejí být čisté. Používejte gumové kladivo k naražení vrtáku do upínače.
5. Při vrtání je doporučeno použít chlazení a mazání, které musí být přivedeno na břit vrtáku v dostatečné míře a bez přerušování.
6. Při vrtání je základem správný odvod materiálu ve formě třísek. Třísky se nesmí zasekávat v drážkách vrtáku.
7. Při přebrušování vrtáku dbejte na dodržení geometrie špičky a odstraňte veškeré opotřebení.



MONOLITNÍ KARBIDOVÉ A HSS VRTÁKY – TECHNICKÉ INFORMACE

Vrtání hlubokých otvorů

Při vrtání hlubokých otvorů lze k dosažení požadované hloubky použít několik metod. Níže uvedený příklad uvádí čtyři způsoby, jak vyvrtat otvor do hloubky 10 x průměr vrtáku.

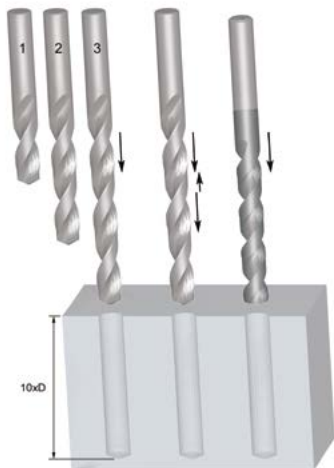

	Postupné vrtání	Postupné vrtání
Počet vrtáků	3 (2,5×D, 6×D, 10×D)	2 (2,5×D, 10×D)
Druh vrtáku	Standardní geometrie, všeobecné použití	Standardní geometrie, všeobecné použití
+ / -	Nákladné, časově náročné	Uspornější, rychlé

	Vrtání s vyjžděním	Vrtání na jeden průchod
Počet vrtáků	1 (10×D)	1 (10×D)
Druh vrtáku	Standardní geometrie, všeobecné použití	Aplikace speciálního nástroje
+ / -	Časově náročné	Uspornější, rychlé

Řešení problémů při vrtání

Problém	Příčina	Náprava
Zlomený nebo zkroucený unašeč	Špatné spojení mezi stopkou a nástavcem	Ujistěte se, že stopka a nástavec jsou čisté a nepoškozené.
Rozlomení jádra	Příliš velký posuv	Zmenšete posuv na optimální hodnotu.
	Nedostatečný úhel hřbetu	Přebušte do požadovaných rozměrů.
	Neúměrné ztenčení jádra	Přebušte do požadovaných rozměrů.
	Velké zatížení špičky vrtáku	Vyhnete se nárazům špičky vrtáku. Při vkládání a vyjímání vrtáku s kuželovou stopkou z vřetena postupujte opatrně.
Opotřebované vnější břity	Příliš velká rychlost	Snižte rychlost na optimální hodnotu - je možné zvětšit posuv.
Vylomené vnější břity	Nestabilní upnutí součástky	Omezte pohyb součástky.
Vyštípané břity	Příliš velký podbrus hřbetu	Přebušte do požadovaných rozměrů.
Zlomení na konci drážek u stopky	Ucpávání drážek	Vyzkoušejte vrtání s opětovným vyjžděním vrtáku, nebo postupné vrtání několika vrtáky.
	Vrták vykluzuje	Zajistěte, aby byl vrták pevně upnut ve sklíčidle a vřeteni.
Spirálovitá stopa v povrchu otvoru	Nedostatečný posuv	Zvyšte posuv.
	Nepřesné umístění vrtáku	Před vrtáním použijte navrtávk.
Příliš velký rozměr otvoru	Špatná geometrie špičky	Zkontrolujte geometrii špičky.
	Neúčinný odvod třísky	Upravte rychlost, posuv a délku vyjždění vrtáku a odvod třísek bude plynulý.



MONOLITNÍ KARBIDOVÉ A HSS VRTÁKY – TECHNICKÉ INFORMACE

Velikost otvoru / dosažitelné tolerance otvoru

S pokročilými konfiguracemi geometrie, substrátu a povlaku se zvyšuje schopnost vrtáku vytvářet přesnější otvory. Obecně platí, že nástroj se standardní geometrií dosáhne tolerance otvoru do přesnosti

H12. Díky složitější konstrukci vrtáku můžeme za příznivých podmínek dosáhnout i tolerance H8.

Abychom vám poskytli lepší přehled, níže jsou uvedeny typy produktů a jejich dosažitelné tolerance otvorů:

HSS pro běžné použití – H12

HSS/HSCo vrtáky pro hluboké otvory s parabolickou konstrukcí drážky (PFX) – H10

HSS/HSCo vysoce výkonné vrtáky s povlakem TiN/TiALN (ADX) – H10

Vysoce výkonné vrtáky z monolitního karbidu s povlakem TiN/TiALN (CDX, Force) – H8/H9

Jmenovitý průměr otvoru (mm)

Ø (mm)	H8	H9	H10	H12
≤ 3	0 / +0.014	0 / +0.025	0 / +0.040	0 / +0.100
> 3 ≤ 6	0 / +0.018	0 / +0.030	0 / +0.048	0 / +0.120
> 6 ≤ 10	0 / +0.022	0 / +0.036	0 / +0.058	0 / +0.150
> 10 ≤ 18	0 / +0.027	0 / +0.043	0 / +0.070	0 / +0.180
> 18 ≤ 30	0 / +0.033	0 / +0.052	0 / +0.084	0 / +0.210

Jmenovitý průměr otvoru (palce)

Ø (inch)	H8	H9	H10	H12
≤ .1181	0 / +0.0006"	0 / +0.0010"	0 / +0.0016"	0 / +0.0040"
>.1181≤.2362	0 / +0.0007"	0 / +0.0012"	0 / +0.0019"	0 / +0.0048"
>.2362≤.3937	0 / +0.0009"	0 / +0.0015"	0 / +0.0023"	0 / +0.0059"
>.3937≤.7087	0 / +0.0011"	0 / +0.0017"	0 / +0.0028"	0 / +0.0071"
>.7087≤1.1811	0 / +0.0013"	0 / +0.0021"	0 / +0.0033"	0 / +0.0083"

S ohledem na schopnost některých vrtáků vytvářet mnohem přesnější toleranci otvorů, je třeba náležitě zohlednit vyvrtané otvory, které podléhají sekundárním operacím (např. závitování, vystružování).

Průměr vrtáku bude muset být oproti doporučení zvětšen, aby se zohlednila skutečnost, že vyrobený průměr otvoru bude menší.

Optimalizace vrtací operace / odstraňování problémů

Výběr vrtáku

K dosažení maximální tuhosti nástroje použijte nejkratší možný vrták.

Upínače

Upínače nástrojů a kleštiny musí zajišťovat dobrou soustřednost mezi vrtákem a vřetenem stroje. Pomocí pozitivního dorazu zabraňte, aby se nástroj v upínači posunul zpět. Nikdy nepřipevňujte nástroj přes drážky a neutahujte upínač nadměrně. Je třeba přesně zkontrolovat a udržovat statické házení sestavných nástrojů.

Obrobek

Je třeba zajistit bezpečný a tuhý obrobek, který minimalizuje průhyb, zejména u aplikací s průchozími otvory.

Chladicí kapaliny

Chladicí kapaliny se doporučují při vrtání měkké oceli a vysokoteplotních slitin. Účelem chladicího média je odvádět třísky od řezného nástroje a obrobku. Nadměrný tlak chladicí kapaliny nebo příliš velký objem mohou negativně ovlivnit výkon. Pokud používáte vrtáky s přívodem chladicí kapaliny, požadovaný tlak chladicí kapaliny by měl být vyšší než obvykle. Doporučený tlak pro vrtáky s přívodem chladicí kapaliny je minimálně 10,3 bar nebo 150 PSI. Čím menší je průměr vrtáku, tím vyšší tlak je zapotřebí. Zlepší se tím odvod třísek z místa řezu.



MONOLITNÍ KARBIDOVÉ A HSS VRTÁKY – TECHNICKÉ INFORMACE

Průvodce odstraňováním problémů při vrtání

Problém	Řešení
Opořebení na vnějších špičkách	Snižte řeznou rychlost.
	Zvyšte posuv (IPR).
	Upravte směr proudění chladicí kapaliny.
	Zvyšte tlak chladicí kapaliny.
Porušování řezné hrany příčného ostří	Zkontrolujte přesnost házení vrtáku.
	Zkontrolujte přesnost a pohyb upnutí obrobku.
	Zkontrolujte centralitu špičky a výšku bříty.
	Zvyšte rychlost posuvu.
Porušování řezných hran řezných břitů	Zkontrolujte přesnost házení vrtáku.
	Zkontrolujte přesnost a pohyb upnutí obrobku.
	Snižte rychlost.
	Zmenšete odlehčení špiček.
	Zvyšte vybroušení.
Praskání vedlejších hřbetů	Zkontrolujte, zda je obrobek stabilní.
	Zvětšete zpětnou kuželovitost.
	Zkontrolujte přesnost házení vrtáku.
	Péčování třísek; použijte otevřenější drážku šroubovice nebo vrtejte přerušovaně (pouze HSS nebo HSCO).
	Zpomalte šroubovici, horizontální vrtání.
	Zvyšte posuv.
	Při bodovém vrtání snižte posuv.
	Upravte směr proudění chladicí kapaliny.
	Zvyšte tlak chladicí kapaliny.
Větší průměr otvoru	Zvyšte rychlost, snižte posuv.
	Zkontrolujte přesnost a pohyb upnutí obrobku.
	Zkontrolujte přesnost házení vrtáku.
	Péčování třísek; použijte otevřenější drážku šroubovice nebo vrtejte cyklicky (pouze HSS nebo HSCO).
	Zkontrolujte centralitu špičky a výšku bříty.
Nedostatečná velikost otvoru	Upravte směr proudění chladicí kapaliny.
	Snižte řeznou rychlost, zvyšte posuv.
	Zkontrolujte průměr vrtáku.
Oválný otvor	Zkontrolujte přesnost házení vrtáku.
	Zkontrolujte přesnost a pohyb upnutí obrobku.
	Zkontrolujte centralitu špičky a výšku bříty.
	Péčování třísek; použijte otevřenější drážku šroubovice nebo vrtejte cyklicky (pouze HSS nebo HSCO).
Zlomení vrtáku	Péčování třísek; použijte otevřenější drážku šroubovice nebo vrtejte cyklicky (pouze HSS nebo HSCO).
	Zkontrolujte přesnost a pohyb upnutí obrobku.
	Zkontrolujte přesnost házení vrtáku.
	Snižte posuv, zvyšte posuv.
	Upravte směr proudění chladicí kapaliny.
	Zvyšte tlak chladicí kapaliny.



VŠEOBECNÁ ČÁST – TECHNICKÉ INFORMACE

	Materiál	Tvrdość (HV10)	C %	W %	Mo %	Cr %	V %	Co %	Materiál nástroje
HSS	M2	810 – 850	0.9	6.4	5.0	4.2	1.8	–	HSS
HSS-E	M35	830 – 870	0.93	6.4	5.0	4.2	1.8	4.8	HSCO
	M42	870 – 960	1.08	1.5	9.4	3.9	1.2	8.0	

Vlastnosti	HSS materiály	Karbidové materiály	K10/30F (často použito pro monolitní nástroje)
Tvrdość (HV30)	800-950	1300 – 1800	1600
Hustota (g/cm³)	8.0 – 9.0	7.2 – 15	14.45
Pevność v tlaku (N/mm²)	3000 – 4000	3000 – 8000	6250
Pevność v ohybu (N/mm²)	2500 – 4000	1000 – 4700	4300
Tepelná odolność (°C)	550	1000	900
E modul (KN/mm²)	260 – 300	460 – 630	580
Velikość zrna (µm)	–	0.2 – 10	0.8

Kombinace tvrdých částic (WC) a pojivového kovu (Co) poskytuje následující změny charakteristik.

Charakteristika	Vyšší obsah WC poskytuje	Vyšší obsah Co poskytuje
Tvrdość	Vyšší tvrdość	Nižší tvrdość
Pevność v tlaku (CS)	Vyšší CS	Nižší CS
Pevność v ohybu (BS)	Nižší BS	Vyšší BS

Vlastnosti materiálu také ovlivňují velikost zrna. Malé velikosti zrna znamenají vyšší tvrdość a hrubá zrna poskytují větší houževnatost.

Příklady povrchových úprav / vlastností povlaků

Povrchové úpravy	Barva	Materiál povlaku	Tvrdość (HV)	Tloušťka (µm)	Struktura povlaku	Koeficient tření oproti oceli	Max. tepl. apl. (°C)
	Tmavě šedá	Fe 304	400	Max. 5	Úprava povrchu	–	550
	Bronz	Fe 304	400	Max. 5	Úprava povrchu	–	550
	Zlatá	TiN	2300	1-4	Monovrstva	0.4	600
	Šedo-černá	TiAlN	3300	3	Nanostruktura	0.3-0.35	900



VŠEOBECNÁ ČÁST – TECHNICKÉ INFORMACE

Průmyslové standardní tolerance pro hřídele a otvory

Hodnoty tolerance jsou uvedeny v mikrometrech (µm)

Přepočít pro mikrometry...1 µm = 0,001 mm / 0,000039"

Tolerance	Průměr (mm)							
	> 1 ≤ 3	> 3 ≤ 6	> 6 ≤ 10	> 10 ≤ 18	> 18 ≤ 30	> 30 ≤ 50	> 50 ≤ 80	> 80 ≤ 120
	Průměr (inch)							
	> 0.039" ≤ 0.118"	> 0.118" ≤ 0.236"	> 0.236" ≤ 0.394"	> 0.394" ≤ 0.709"	> 0.709" ≤ 1.181"	> 1.181" ≤ 1.968"	> 1.968" ≤ 3.149"	> 3.149" ≤ 4.724"
Hodnoty tolerance (µm)								
e8	-14 / -28	-20 / -38	-25 / -47	-32 / -59	-40 / -73	-50 / -89	-60 / -106	-72 / -126
f6	-6 / -12	-10 / -18	-13 / -22	-16 / -27	-20 / -33	-25 / -41	-30 / -49	-36 / -58
f7	-6 / -16	-10 / -22	-13 / -28	-16 / -34	-20 / -41	-25 / -50	-30 / -60	-36 / -71
h6	0 / -6	0 / -8	0 / -9	0 / -11	0 / -13	0 / -16	0 / -19	0 / -22
h7	0 / -10	0 / -12	0 / -15	0 / -18	0 / -21	0 / -25	0 / -30	0 / -35
h8	0 / -14	0 / -18	0 / -22	0 / -27	0 / -33	0 / -39	0 / -46	0 / -54
h9	0 / -25	0 / -30	0 / -36	0 / -43	0 / -52	0 / -62	0 / -74	0 / -87
h10	0 / -40	0 / -48	0 / -58	0 / -70	0 / -84	0 / -100	0 / -120	0 / -140
h11	0 / -60	0 / -75	0 / -90	0 / -110	0 / -130	0 / -160	0 / -190	0 / -220
h12	0 / -100	0 / -120	0 / -150	0 / -180	0 / -210	0 / -250	0 / -300	0 / -350
k10	+40 / 0	+48 / 0	+58 / 0	+70 / 0	+84 / 0	+100 / 0	+120 / 0	+140 / 0
k12	+100 / 0	+120 / 0	+150 / 0	+180 / 0	+210 / 0	+250 / 0	+300 / 0	+350 / 0
m7	+2 / +12	+4 / +16	+6 / +21	+7 / +25	+8 / +29	+9 / +34	+11 / +41	+13 / +48
js14	+/-125	+/-150	+/-180	+/-215	+/-260	+/-310	+/-370	+/-435
js16	+/-300	+/-375	+/-450	+/-550	+/-650	+/-800	+/-950	+/-1100
H7	+10 / 0	+12 / 0	+15 / 0	+18 / 0	+21 / 0	+25 / 0	+30 / 0	+35 / 0
H8	+14 / 0	+18 / 0	+22 / 0	+27 / 0	+33 / 0	+39 / 0	+46 / 0	+54 / 0
H9	+25 / 0	+30 / 0	+36 / 0	+43 / 0	+52 / 0	+62 / 0	+74 / 0	+87 / 0
H12	+100 / 0	+120 / 0	+150 / 0	+180 / 0	+210 / 0	+250 / 0	+300 / 0	+350 / 0
P9	-6 / -31	-12 / -42	-15 / -51	-18 / -61	-22 / -74	-26 / -86	-32 / -106	-37 / -124
S7	-13 / -22	-15 / -27	-17 / -32	-21 / -39	-27 / -48	-34 / -59	-42 / -72	-58 / -93



VŠEOBECNÁ ČÁST – TECHNICKÉ INFORMACE

Tabulka řezných rychlostí

		Vc															
m/min		5	8	10	15	20	25	30	40	50	60	70	80	90	100	110	150
SFM (feet/min.)		16	26	32	50	66	82	98	130	165	197	230	262	296	330	362	495
Ø		ot/min															
mm	inch																
1.00	–	1592	2546	3183	4775	6366	7958	9549	12732	15916	19099	22282	25465	28648	31831	35014	47747
1.50	–	1061	1698	2122	3183	4244	5305	6366	8488	10610	12732	14854	16977	19099	21221	23343	31831
2.00	–	796	1273	1592	2387	3183	3979	4775	6366	7958	9549	11141	12732	14324	15916	17507	23873
2.50	–	637	1019	1273	1910	2546	3183	3820	5093	6366	7639	8913	10186	11459	12732	14006	19099
3.00	–	531	849	1061	1592	2122	2653	3183	4244	5305	6366	7427	8488	9549	10610	11671	15916
3.18	1/8	500	801	1001	1501	2002	2502	3003	4004	5005	6006	7007	8008	9009	10010	11011	15015
3.50	–	455	728	909	1364	1819	2274	2728	3638	4547	5457	6366	7276	8185	9095	10004	13642
4.00	–	398	637	796	1194	1592	1989	2387	3183	3979	4775	5570	6366	7162	7958	8754	11937
4.50	–	354	566	707	1061	1415	1768	2122	2829	3537	4244	4951	5659	6366	7074	7781	10610
4.76	3/16	334	535	669	1003	1337	1672	2006	2675	3344	4012	4681	5350	6018	6687	7356	10031
5.00	–	318	509	637	955	1273	1592	1910	2546	3183	3820	4456	5093	5730	6366	7003	9549
6.00	–	265	424	531	796	1061	1326	1592	2122	2653	3183	3714	4244	4775	5305	5836	7958
6.35	1/4	251	401	501	752	1003	1253	1504	2005	2506	3008	3509	4010	4511	5013	5514	7519
7.00	–	227	364	455	682	909	1137	1364	1819	2274	2728	3183	3638	4093	4547	5002	6821
7.94	5/16	200	321	401	601	802	1002	1203	1604	2004	2405	2806	3207	3608	4009	4410	6013
8.00	–	199	318	398	597	796	995	1194	1592	1989	2387	2785	3183	3581	3979	4377	5968
9.00	–	177	283	354	531	707	884	1061	1415	1768	2122	2476	2829	3183	3537	3890	5305
9.53	3/8	167	267	334	501	668	835	1002	1336	1670	2004	2338	2672	3006	3340	3674	5010
10.00	–	159	255	318	477	637	796	955	1273	1592	1910	2228	2546	2865	3183	3501	4775
11.11	7/16	143	229	287	430	573	716	860	1146	1433	1719	2006	2292	2579	2865	3152	4298
12.00	–	133	212	265	398	531	663	796	1061	1326	1592	1857	2122	2387	2653	2918	3979
12.70	1/2	125	201	251	376	501	627	752	1003	1253	1504	1754	2005	2256	2506	2757	3760
14.00	–	114	182	227	341	455	568	682	909	1137	1364	1592	1819	2046	2274	2501	3410
14.29	9/16	111	178	223	334	446	557	668	891	1114	1337	1559	1782	2005	2228	2450	3341
15.00	–	106	170	212	318	424	531	637	849	1061	1273	1485	1698	1910	2122	2334	3183
15.88	5/8	100	160	200	301	401	501	601	802	1002	1203	1403	1604	1804	2004	2205	3007
16.00	–	99	159	199	298	398	497	597	796	995	1194	1393	1592	1790	1989	2188	2984
17.46	11/16	91	146	182	273	365	456	547	729	912	1094	1276	1458	1641	1823	2005	2735
18.00	–	88	141	177	265	354	442	531	707	884	1061	1238	1415	1592	1768	1945	2653
19.05	3/4	84	134	167	251	334	418	501	668	835	1003	1170	1337	1504	1671	1838	2506
20.00	–	80	127	159	239	318	398	477	637	796	955	1114	1273	1432	1592	1751	2387
24.00	–	66	106	133	199	265	332	398	531	663	796	928	1061	1194	1326	1459	1989
25.00	–	64	102	127	191	255	318	382	509	637	764	891	1019	1146	1273	1401	1910
27.00	–	59	94	118	177	236	295	354	472	589	707	825	943	1061	1179	1297	1768
30.00	–	53	85	106	159	212	265	318	424	531	637	743	849	955	1061	1167	1592
32.00	–	50	80	99	149	199	249	298	398	497	597	696	796	895	995	1094	1492
36.00	–	44	71	88	133	177	221	265	354	442	531	619	707	796	884	973	1326
40.00	–	40	64	80	119	159	199	239	318	398	477	557	637	716	796	875	1194
50.00	–	32	51	64	95	127	159	191	255	318	382	446	509	573	637	700	955



VŠEOBECNÁ ČÁST – TECHNICKÉ INFORMACE

Tvrdość a pevnost v tahu

HV	HRC	HB	Pevnost v tahu	
			N/mm ²	Tons /sq. in.
Vickers	Rockwell	Brinell		
940	68	–	–	–
900	67	–	–	–
864	66	–	–	–
829	65	–	–	–
800	64	–	–	–
773	63	–	–	–
745	62	–	–	–
720	61	–	–	–
698	60	–	–	–
675	59	–	–	–
655	58	–	2200	142
650	–	618	2180	141
640	–	608	2145	139
639	57	607	2140	138
630	–	599	2105	136
620	–	589	2070	134
615	56	584	2050	133
610	–	580	2030	131
600	–	570	1995	129
596	55	567	1980	128
590	–	561	1955	126
580	–	551	1920	124
578	54	549	1910	124
570	–	542	1880	122
560	53	532	1845	119
550	–	523	1810	117
544	52	517	1790	116
540	–	513	1775	115
530	–	504	1740	113
527	51	501	1730	112
520	–	494	1700	110
514	50	488	1680	109
510	–	485	1665	108
500	–	475	1630	105
497	49	472	1620	105
490	–	466	1595	103
484	48	460	1570	102
480	–	456	1555	101
473	47	449	1530	99
470	–	447	1520	98
460	–	437	1485	96
458	46	435	1480	96
450	–	428	1455	94
446	45	424	1440	93
440	–	418	1420	92

HV	HRC	HB	Pevnost v tahu	
			N/mm ²	Tons /sq. in.
Vickers	Rockwell	Brinell		
434	44	413	1400	91
423	43	402	1360	88
413	42	393	1330	86
403	41	383	1300	84
392	40	372	1260	82
382	39	363	1230	80
373	38	354	1200	78
364	37	346	1170	76
355	36	337	1140	74
350	–	333	1125	73
345	35	328	1110	72
340	–	323	1095	71
336	34	319	1080	70
330	–	314	1060	69
327	33	311	1050	68
320	–	304	1030	67
317	32	301	1020	66
310	31	295	995	64
302	30	287	970	63
300	–	285	965	62
295	–	280	950	61
293	29	278	940	61
290	–	276	930	60
287	28	273	920	60
285	–	271	915	59
280	27	266	900	58
275	–	261	880	57
272	26	258	870	56
270	–	257	865	56
268	25	255	860	56
265	–	252	850	55
260	24	247	835	54
255	23	242	820	53
250	22	238	800	52
245	–	233	785	51
243	21	231	780	50
240	–	228	770	50
235	–	223	755	49
230	–	219	740	48
225	–	214	720	47
220	–	209	705	46
215	–	204	690	45
210	–	199	675	44
205	–	195	660	43
200	–	190	640	41



ŘEZNÉ KAPALINY



M200-1



M200 Blue, Řezný olej - modrý, pro těžké operace

Vysoce výkonný řezný olej pro těžké operace jako je závitování, protahování a ruční vrtání i strojní vrtání na sloupových vrtačkách. Pro zvýšení životnosti nástroje a zlepšení jakosti povrchu. První volba pro běžnou ocel, nerez, litinu a superslitinu na bázi titanu.

Produkt	Nr.
M2000.25NR.1BLUE	1/4 Ltr. 12x
M2001.0NR.1BLUE	1 Ltr.
M2005.0NR.1BLUE	5 Ltr.
M20020.0NR.1BLUE	20 Ltr.

M200-2



M200 Red, Řezný olej - červený, pro neželezné kovy

Řezný olej pro operace vyžadující dobré odstraňování třísek při obrábění hliníku a jeho slitin. Má mazací a chladicí schopnost, zvyšuje životnost nástrojů a zajišťuje vysokou jakost obrobeného povrchu. Nízká zátěž k životnímu prostředí vzhledem k potlačení olejové mlhy, oxidační stabilitě a sníženému zápachu.

Produkt	Nr.
M2000.25NR.2RED	1/4 Ltr. 12x
M2001.0NR.2RED	1 Ltr.
M2005.0NR.2RED	5 Ltr.



M200-3



M200 Green, Řezný olej - zelený, pro všeobecné použití

Vysoce výkonný řezný olej s aditivy, snáší vysoké tlaky a zvyšuje životnost nástrojů. Pro běžné řezné a tvářecí operace jako je závitování, protahování a vrtání, vhodný pro legovenou ocel, nerez a superslitinu na bázi titanu a niklu.

Produkt	Nr.
M2000.25NR.3GREEN	1/4 Ltr. 12x
M2001.0NR.3GREEN	1 Ltr.
M2005.0NR.3GREEN	5 Ltr.



DORMER PRAMET



LETECKÝ PRŮMYSL

Do našeho sortimentu řezných nástrojů jsme přidali nové produkty se specifickým zaměřením na opláštění letadel a montáže. Všechny produkty jsou obsaženy v nové publikaci, která je k dispozici ke stažení. **Jsme jednoduše spolehliví.**



**VÝSTRUŽNÍKY
A ZÁHLUBNÍKY**



6		WMG A ISO 13399
12	MONOLITNÍ VRTÁKY	NÁVOD
15		MONOLITNÍ KARBIDOVÉ VRTÁKY
66		HSS VRTÁKY
176		TECHNICKÉ INFORMACE
186		ŘEZNÉ KAPALINY
190		VÝSTRUŽNÍKY A ZÁHLUBNÍKY
264	DESTIČKOVÉ VRTÁKY	NÁVOD
271		VRTÁKY HYDRA
297		TECHNICKÉ INFORMACE
307		DESTIČKOVÉ VRTÁKY
327		TECHNICKÉ INFORMACE
350	VYVRTÁVACÍ SYSTÉMY	NÁVOD
359		VYVRTÁVACÍ HLAVY
376		PŘÍSLUŠENSTVÍ PRO VYVRTÁVÁNÍ
381		BŘITOVÉ DESTIČKY
404		UPÍNACÍ TRNY
418		VYVRTÁVACÍ SADY
429		TECHNICKÉ INFORMACE



VÝSTRUŽNÍKY A ZÁHLUBNÍKY – PŘEHLED STRÁNKY

1

B400

DORMER



3

Karbidový strojní výstružník s tolerancí H7 a válcovou stopkou, Leštěný

Konstruován pro dosažení tolerance otvoru H7. Výkonný výstružník s dlouhou trvanlivostí i při obrábění tvrdých a abrazivních materiálů. Břity ve šroubovici s extrémně nerovnoměrnou zubovou roztečí snižují vibrace a zlepšují kruhovitosť otvorů, rozměrovou přesnost i jakost povrchu.

2

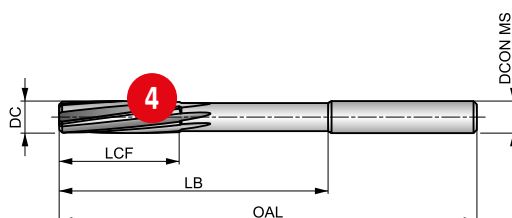

HM	Bright	DIN 8093
R	B	
H7		

5

Materiálové skupiny obrobků a vhodné startovací řezné podmínky (m/min) a posuv Alpha Code. Tabulku s posuvem na otáčku naleznete od strany 251.

P1.1	P1.2	P1.3	P2.1	P2.2	P2.3	P3.1	P3.2	P3.3	P4.1	P4.2	P4.3	M1.1	M1.2
■ 23 B	■ 26 B	■ 27 B	■ 20 B	■ 18 B	■ 16 C	■ 16 B	■ 13 B	■ 11 C	■ 10 B	■ 8 C	■ 7 C	■ 10 C	■ 8 C
M2.1	M2.2	M2.3	K1.1	K1.2	K1.3	K2.1	K2.2	K2.3	K3.1	K3.2	K3.3	K5.1	K5.2
■ 9 C	■ 7 C	■ 16 B	■ 20 D	■ 15 D	■ 11 D	■ 21 D	■ 17 D	■ 14 D	■ 18 D	■ 14 D	■ 11 D	■ 19 D	■ 15 D
K5.3	N1.1	N1.2	N1.3	N2.1	N2.2	N2.3	N3.1	N3.2	N3.3	N4.1	N4.2		
■ 11 D	■ 60 D	■ 45 D	■ 30 D	■ 38 D	■ 35 D	■ 25 D	■ 64 E	■ 38 E	■ 19 E	■ 35 C	■ 30 C		

6

DCON MS v toleranci h6; DC >= 14mm karbidová hlava.

Product	DC	OAL	LCF	LB	NOF	DCON MS
	[mm]	[mm]	[mm]	[mm]		[mm]
B4001.0	1.00	34.0	5.5	15.00	3	1.00
B4001.2	1.20	38.0	7.5	16.50	3	1.20
B4001.4	1.40	40.0	8.0	18.00	3	1.50
B4001.5	1.50	40.0	8.0	18.00	3	1.50
B4001.6	1.60	43.0	9.0	20.00	3	1.60
B4001.8	1.80	46.0	10.0	22.00	4	1.80
B4002.0	2.00	49.0	11.0	24.00	4	2.00
B4002.2	2.20	53.0	12.0	25.00	4	2.20
B4002.5	2.50	57.0	14.0	27.00	4	2.50
B4003.0	2.80	61.0	15.0	30.00	6	3.00
B4003.0	3.00	61.0	15.0	33.00	6	3.00
B4003.2	3.20	65.0	16.0	37.00	6	3.20

7

8

Product	DC	OAL	LCF	LB	NOF	DCON MS
	[mm]	[mm]	[mm]	[mm]		[mm]
B4004.5	4.50	80.0	21.0	52.00	6	4.50
B4005.0	5.00	86.0	23.0	58.00	6	5.00
B4005.5	5.50	93.0	26.0	57.00	6	5.60
B4006.0	6.00	93.0	26.0	57.00	6	5.60
B4006.5	6.50	101.0	28.0	65.00	6	6.30
B4007.0	7.00	109.0	31.0	73.00	6	7.10
B4008.0	8.00	117.0	33.0	81.00	6	8.00
B4009.0	9.00	125.0	36.0	85.00	6	9.00
B40010.0	10.00	133.0	38.0	93.00	6	10.00
B40012.0	12.00	151.0	44.0	111.00	6	10.00
B40014.0	14.00	160.0	47.0	115.00	6	12.50
B40016.0	16.00	170.0	52.0	125.00	6	12.50

Poz.	Popis
1	Označení vrtáku
2	Popis produktu
3	Zobrazení produktu
4	Schematické vyobrazení nástroje

Poz.	Popis
5	Parametry produktu
6	Doporučení skupiny materiálů vč. pokynů ohledně řezné rychlosti a posuvu
7	Kód produktu
8	Rozměry produktu



VÝSTRUŽNÍKY A ZÁHLUBNÍKY – PŘEHLED IKON

OBECNÉ IKONY

	Hlavní použití
	Podmíněné použití

DOSAŽITELNÉ TOLERANČNÍ POLE OTVORŮ (TCHA)

	H7 – Toleranční pole otvorů pro průmyslovou normu (na základě rozsahu průměrů)		k11 – Toleranční pole nástrojů pro průmyslovou normu (na základě rozsahu průměrů)
	Vysoce přesné toleranční pole otvorů (na základě rozsahu průměrů)		

APLIKAČNÍ ÚHEL

	Záhlubník 100°		Kuželový výstružník 20°		Záhlubník 82°
	Válcový záhlubník 180°		Záhlubník 60°		Záhlubník 90°

NORMY (BSG)

	ANSI – Normy pro závitníky		DIN 219 – Normy pro nástrčné výstružníky		DIN 8050 – Normy pro výstružníky s válcovou stopkou
	BS 328 – Normy pro vrtáky a výstružníky		DIN 311 – Normy pro výstružníky s kuželovým náběhem s kuzelem Morse		DIN 8051 – Normy pro výstružníky s kuzelem Morse
	DIN 206 – Normy pro ruční výstružníky		DIN 334 C – Normy pro záhlubníky s rovnou stopkou		DIN 8093 – Normy pro výstružníky s rovnou stopkou
	DIN 208 – Normy pro sklíčidlový výstružník s kuzelem Morse		DIN 334 D – Normy pro záhlubníky s kuzelem Morse		DIN 8094 – Normy pro výstružníky s kuzelem Morse
	DIN 212 – Normy pro strojní výstružníky		DIN 335 A – Normy pro záhlubníky s rovnou stopkou		DIN 9 – Normy pro výstružníky s kuželovým kolíkem
	DIN 217 – Normy pro nástrčné výstružníky pro nasazení na trn		DIN 335 C – Normy pro záhlubníky s rovnou stopkou		Normy Dormer
	DIN 2179 – Normy pro výstružníky s válcovou stopkou s kuželovým kolíkem		DIN 335 D – Normy pro záhlubníky s kuzelem Morse		
	DIN 2180 – Normy pro výstružníky s kuzelem Morse s kuželovým kolíkem		DIN 373 – Normy pro válcové záhlubníky		

POVLAK

	Povlak nitridem hliníku, titanu a uhlíku		Kombinace broušeného a černěného povrchu		Povlak nitridem titanu a hliníku
	Broušený (bez povlaku)		Povrchová úprava oxidem bronzu a vaporizací		S povlakem nitridu titanu

SMĚR ŘEZU

	Pravostranné otáčení / řez
--	----------------------------

KÓD MATERIÁLU (BMC)

	Tvrký materiál (monolitní karbid)		Materiál nástroje HSS
	Materiál nástroje z kobaltové oceli HSS		







VÝSTRUŽNÍKY A ZÁHLUBNÍKY – PŘEHLED IKON

TVAR VÝSTRUŽNÍKU

A	DIN Tvar A – přímá drážka $\leq \varnothing 3,5$ mm
B	DIN Tvar B – spirálová drážka $\leq \varnothing 3,5$ mm
E	DIN Tvar C – přímá drážka $\geq \varnothing 4,0$ mm

STOPKA

	Válcová stopka / rovná stopka		Válcová stopka s unášečem
	Válcová stopka s trojploškou		Válcová stopka DIN 6535 HA
	Válcová stopka se šestihranem		Stopka kužele Morse
	Válcová stopka se čtyřhranem		



SKLON KUŽELE – MILIMETR (KUŽELOVITOST)

1:48 	Sklon kužele (kuželovitost 1/4" na stopu)	1:50 	Sklon kužele (kuželovitost 1 mm na 50 mm)
---	---	--	---



VÝSTRUŽNÍKY A ZÁHLUBNÍKY – NAVIGÁTOR PRO MATERIÁLY NÁSTROJE







Materiály nástroje

Rychlořezná ocel	 HSS	Středně legovaná rychlořezná ocel, která má dobrou obrobiteľnosť a dobrý výkon. HSS vykazuje vlastnosti, jako je tvrdost, houževnatost a odolnost vůči opotřebení, díky nimž je atraktivní v široké škále aplikací například u vrtáků a závitníků.
Rychlořezná kobaltová ocel	 HSS-E	Tato rychlořezná ocel obsahuje kobalt pro zvýšení tvrdosti za tepla. Složení HSCo poskytuje dobrou kombinaci houževnatosti a tvrdosti. Má dobrou obrobiteľnosť a dobrou odolnost vůči opotřebení, a proto je použitelná pro výrobu vrtáků, závitníků, výstružníků a fréz.

Karbidové materiály

Karbidové materiály	 HM	<p>Substrát vyrobený slinováním pomocí práškové metalurgie sestávající z kompozitu kovového karbidu s pojivovým kovem. Nejvýznamnější surovinou je wolfram-karbid (WC). Wolfram-karbid přispívá k tvrdosti materiálu. Karbid tantalu (TaC), karbid titanu (TiC) a karbid niobu (NbC) doplňují WC a upravují vlastnosti podle požadavku. Tyto tři materiály se nazývají kubické karbidy. Kobalt (Co) působí jako pojivo a udržuje materiál pohromadě.</p> <p>Karbidové materiály se často vyznačují vysokou pevností v tlaku, vysokou tvrdostí, a tedy vysokou odolností vůči opotřebení, ale také omezenou pevností v ohybu a houževnatostí. Karbid se používá u závitníků, výstružníků, fréz, vrtáků a závitových fréz.</p>
----------------------------	---	--

Povrchové povlaky

Nitrid titanu (TiN)	 TiN	Povlak nitridem titanu je zlatě zbarvený keramický povlak aplikovaný fyzikálním nanášením par (PVD). Vysoká tvrdost v kombinaci s nízkým třením zajišťuje podstatně delší životnost nástroje nebo alternativně lepší řezný výkon oproti nástrojům, které nebyly opatřeny povlakem. Povlak TiN se používá hlavně pro vrtáky a závitníky.
Povlak nitridem hliníku, titanu a uhlíku (AlTiCN)	 AlTiCN	Povlak nitridem hliníku, titanu a uhlíku (AlTiCN) je PVD povlak, který byl speciálně vyvinut tak, aby splňoval přísné požadavky odvětví zdravotnických prostředků. Díky vynikajícím vlastnostem mikrotvrdosti a přilnavosti a dále díky vysoce kvalitní technologii tenkých vrstev je však stejně použitelný pro určité operace řezných nástrojů.
Povlaky nitridem titanu a hliníku (TiAlN)	 TiAlN	Nitrid titanu a hliníku je vícevrstvý keramický povlak nanášený technologií PVD povlakování, která vykazuje vysokou houževnatost a oxidační stabilitu. Díky těmto vlastnostem je ideální pro vyšší rychlosti a posuvy a současně zvyšuje životnost nástroje. TiAlN se používá při vrtání, závitování a frézování a může být vhodný pro použití při obrábění bez chladicí kapaliny.
Broušený (bez povlaku)	 Bright	Broušený povrch (bez povlaku) zlepšuje tok třísek v měkkých nebo neželezných materiálech a přitom si udržuje ostré řezné hrany.
Kombinace broušeného a vaporizovaného povrchu	 Bright ST	Kombinace broušeného a vaporizovaného povrchu může být účinná, protože poréznější povrch modrého oxidu působí na zadržování a natahování řezné kapaliny do otvoru, přičemž broušený povrch pomáhá při odvodu třísek. Těto kombinace je dosaženo broušením lesklého povrchu po temperování.
Povrchová úprava kombinací oxidu bronzu a vaporizací	 ST Bronze	Kombinace oxidu bronzu a vaporizace může být účinná, protože poréznější povrch modrého oxidu působí na zadržování a natahování řezné kapaliny do otvoru, přičemž bronzový povrch pomáhá při odvodu třísek. Obě povrchové úpravy dodávají nástroji určitý stupeň povrchové ochrany. Těchto kombinací je dosaženo použitím dvou různých temperovacích cyklů.



Materiál nástroje (BMC)	HM	HM	HM	HM	HM	HSS	HSS	HSS	HSS-E	HSS	HSS	HSS	HSS
Povlak	Bright	Bright	Bright	Bright	Bright	Bright ST	Bright		Bright ST	Bright ST	Bright ST	Bright	ST Bronze
Norma (BSG)	DIN 8093	DIN 8093	DIN 8050	DIN 8094	DIN 8051	DIN 206	DORMER	DORMER	BS 328	BS 328	DIN 9	DIN 9	ANSI
Směr chodu (otáček)	R	R	R	R	R	R	R		R	R	R	R	R
Stopka		DIN 6535HA											
Úhel vrcholu													
Typ výstružníku	B	B	A	B	A	B			B	A	A	B	
Tolerance otvoru (TCHA)	H7	$\begin{matrix} \phi.95-5.5 \\ +0.004 \\ \phi5.51-12 \\ +0.005 \end{matrix}$	H7	H7	H7	H7			H7				
Kuželovitost										1:48	1:50	1:50	
Kód produktové řady	B400	B481	B441	B411	B442	B100	B334	B335	B901	B301	B903	B952	B122
	1.00 - 20.00	0.98 - 12.05	10.00 - 20.00	5.00 - 30.00	10.00 - 20.00	1.50 - 50.00	N000 - N16	N000BLADES - N16NUT	1.50 - 1/2	1/16 - 1/2	1.50 - 20.00	1.20 - 50.00	3/8 - 1.1/16
	200	201	203	204	205	206	208	209	210	211	212	213	214
P	P1	■	■	■	■	■	■	■	■	■	■	■	■
	P2	■	■	■	■	■	■	■	■	■	■	■	■
	P3	■	■	■	■	■	■	■	■	■	■	■	■
	P4	■	■	■	■	■	■	■	■	■	■	■	■
M	M1	■	■	■	■	■	■	■	■	■	■	■	■
	M2	■	■	■	■	■	■	■	■	■	■	■	■
	M3												
	M4												
K	K1	■	■	■	■	■	■	■	■	■	■	■	■
	K2	■	■	■	■	■	■	■	■	■	■	■	■
	K3	■	■	■	■	■	■	■	■	■	■	■	■
	K4												
	K5	■	■	■	■	■	■	■	■	■	■	■	■
N	N1	■	■	■	■	■	■	■	■	■	■	■	■
	N2	■	■	■	■	■	■	■	■	■	■	■	■
	N3	■	■	■	■	■	■	■	■	■	■	■	■
	N4	■	■	■	■	■	■	■	■	■	■	■	■
	N5												
S	S1												
	S2												
	S3												
	S4												
H	H1												
	H2												
	H3												
	H4												

■ Hlavní použití ■ Podmíněné použití



	HSS-E	HSS-E	HSS-E	HSS-E	HSS-E	HSS-E	HSS	HSS-E	HSS-E	HSS-E		HM	HSS	HSS
	Bright	Bright	Bright	Bright	Bright	Bright ST	Bright ST	Bright	Bright ST	Bright		Bright	Bright	TIN
	DIN 2179	DIN 212	DIN 212	DIN 212	DIN 208	BS 328	DIN 311	DIN 2180	DIN 219	DIN 217		DIN 335C	DIN 334C	DIN 334C
		B	B	E	B	B		B	B					
	H7		$\begin{matrix} \phi 95-5.5 \\ +0.004 \\ \phi 5.51-12 \\ +0.005 \end{matrix}$	H7	H7	H7	k11	H7	H7				60°	60°
	1:50							1:50						
	B953	B180	B170	B157	B161	B101	B121	B954	B955	B956	B957	G400	G135	G335
	1.00 - 12.00	1.50 - 20.00	0.98 - 12.00	2.00 - 20.00	3.00 - 50.00	3.00 - 2"	10.00 - 30.00	5.00 - 30.00	25.00 - 80.00	13.00 - 40.00	N3DRIVER - N9WASHER	6.30 - 31.00	6.30 - 25.00	6.30 - 25.00
	215	216	218	220	221	222	224	225	226	227	228	229	230	231
P1	■	■	■	■	■	■	■	■	■			■	■	■
P2	■	■	■	■	■	■	■	■	■			■	■	■
P3	■	■	■	■	■	■	■	■	■			■	■	■
P4	■	■	■	■	■	■	■	■	■			■	■	■
M1	■	■	■	■	■	■		■	■			■	■	■
M2	■	■	■	■	■			■	■			■	■	■
M3												■		■
M4												■		
K1	■	■	■		■	■	■	■	■			■	■	■
K2	■	■	■		■	■	■	■	■			■	■	■
K3	■	■	■		■	■	■	■	■			■	■	■
K4												■	■	■
K5												■	■	■
N1	■	■	■	■	■	■	■	■	■			■	■	■
N2	■	■	■	■	■	■	■	■	■			■	■	■
N3	■	■	■	■	■	■	■	■	■			■	■	■
N4	■	■	■		■	■	■	■	■			■	■	■
N5												■		
S1												■		
S2												■		
S3												■		
S4												■		
H1												■		
H2												■		
H3												■		
H4												■		

■ Hlavní použití □ Podmíněné použití



Materiál nástroje (BMC)	HSS	HSS	HSS	HSS-E	HSS	HSS	HSS	HSS	HSS	HSS-E	HSS-E	HSS
Povlak	Bright	Bright	Bright	Bright	Bright	TIAIN	Bright	TIAIN	Bright	ALTiCN	Bright	Bright
Norma (BSG)	DIN 334D	DIN 335C	DORMER	DORMER	DIN 335C	DIN 335C	DIN 335C	DIN 335C	DIN 335C	DIN 335C	DORMER	DORMER
Směr chodu (otáček)	R	R	R	R	R	R	R	R	R	R	R	R
Stopka												
Úhel vrcholu	60°	82°	90°	90°	90°	90°	90°	90°	90°	90°	90°	90°
Typ výstružníku												
Tolerance otvoru (TCHA)												
Kuželovitost												
Kód produktové řady	G137	G154	G129	G149	G136	G560	G106	G506	G142	G570	G107	G600
	16.00 - 80.00	6.30 - 25.00	6.00 - 31.50	5.00 - 50.00	4.30 - 31.00	6.30 - 31.00	6.30 - 50.00	6.30 - 50.00	4.80 - 31.00	6.30 - 31.00	6.30 - 20.50	6.30 - 25.00
P	P1	■	■	■	■	■	■	■	■	■	■	■
	P2	■	■	■	■	■	■	■	■	■	■	■
	P3	■	■	■	■	■	■	■	■	■	■	■
	P4	■	■	■	■	■	■	■	■	■	■	■
M	M1	■	■	■	■	■	■	■	■	■	■	■
	M2	■	■	■	■	■	■	■	■	■	■	■
	M3								■	■	■	■
	M4								■	■	■	■
K	K1	■	■	■	■	■	■	■	■	■	■	■
	K2	■	■	■	■	■	■	■	■	■	■	■
	K3	■	■	■	■	■	■	■	■	■	■	■
	K4						■	■	■	■	■	■
	K5	■	■	■	■	■	■	■	■	■	■	■
N	N1	■	■	■	■	■	■	■	■	■	■	■
	N2	■	■	■	■	■	■	■	■	■	■	■
	N3	■	■	■	■	■	■	■	■	■	■	■
	N4	■	■	■	■	■	■	■	■	■	■	■
	N5											
S	S1											
	S2											
	S3											
	S4											
H	H1											
	H2											
	H3											
	H4											

■ Hlavní použití ■ Podmíněné použití



B400



Karbidový strojní výstružník s tolerancí H7 a válcovou stopkou, Leštěný

Konstruován pro dosažení tolerance otvoru H7. Výkonný výstružník s dlouhou trvanlivostí i při obrábění tvrdých a abrazivních materiálů. Břity ve šroubovici s extrémně nerovnoměrnou zubovou roztečí snižují vibrace a zlepšují kruhovitost otvorů, rozměrovou přesnost i jakost povrchu.

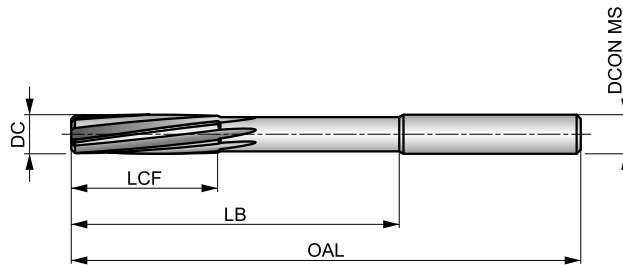

HM	Bright	DIN 8093
R		B
H7		

Skupiny obráběných materiálů, startovní řezná rychlost (Vc m/min) a kód posuvu. Tabulku s posuvem na otáčku naleznete od strany 251.

P1.1 ■ 23 B	P1.2 ■ 26 B	P1.3 ■ 27 B	P2.1 ■ 20 B	P2.2 ■ 18 B	P2.3 ■ 16 C	P3.1 ■ 16 B	P3.2 ■ 13 B	P3.3 ■ 11 C	P4.1 ■ 10 B	P4.2 ■ 8 C	P4.3 ■ 7 C	M1.1 ▣ 10 C	M1.2 ▣ 8 C
M2.1 ▣ 19 C	M2.2 ▣ 17 C	M2.3 ▣ 16 B	K1.1 ■ 20 D	K1.2 ■ 15 D	K1.3 ■ 11 D	K2.1 ■ 21 D	K2.2 ■ 17 D	K2.3 ■ 14 D	K3.1 ■ 18 D	K3.2 ■ 14 D	K3.3 ■ 11 D	K5.1 ■ 19 D	K5.2 ■ 15 D
K5.3 ■ 11 D	N1.1 ▣ 60 D	N1.2 ■ 45 D	N1.3 ■ 30 D	N2.1 ■ 38 D	N2.2 ■ 35 D	N2.3 ■ 25 D	N3.1 ■ 64 E	N3.2 ■ 38 E	N3.3 ▣ 19 E	N4.1 ▣ 35 C	N4.2 ▣ 30 C		

DCON MS v toleranci h6; DC >= 14mm karbidová hlava.

Produkt	DC (mm)	OAL (mm)	LCF (mm)	LB (mm)	NOF	DCON MS (mm)
B4001.0	1.00	34.0	5.5	15.00	3	1.00
B4001.2	1.20	38.0	7.5	16.50	3	1.20
B4001.4	1.40	40.0	8.0	18.00	3	1.50
B4001.5	1.50	40.0	8.0	18.00	3	1.50
B4001.6	1.60	43.0	9.0	20.00	3	1.60
B4001.8	1.80	46.0	10.0	22.00	4	1.80
B4002.0	2.00	49.0	11.0	24.00	4	2.00
B4002.2	2.20	53.0	12.0	25.00	4	2.20
B4002.5	2.50	57.0	14.0	29.00	4	2.50
B4002.8	2.80	61.0	15.0	33.00	6	3.00
B4003.0	3.00	61.0	15.0	33.00	6	3.00
B4003.2	3.20	65.0	16.0	37.00	6	3.20
B4003.5	3.50	70.0	18.0	42.00	6	3.50
B4004.0	4.00	75.0	19.0	47.00	6	4.00

Produkt	DC (mm)	OAL (mm)	LCF (mm)	LB (mm)	NOF	DCON MS (mm)
B4004.5	4.50	80.0	21.0	52.00	6	4.50
B4005.0	5.00	86.0	23.0	58.00	6	5.00
B4005.5	5.50	93.0	26.0	57.00	6	5.60
B4006.0	6.00	93.0	26.0	57.00	6	5.60
B4006.5	6.50	101.0	28.0	65.00	6	6.30
B4007.0	7.00	109.0	31.0	73.00	6	7.10
B4008.0	8.00	117.0	33.0	81.00	6	8.00
B4009.0	9.00	125.0	36.0	85.00	6	9.00
B40010.0	10.00	133.0	38.0	93.00	6	10.00
B40012.0	12.00	151.0	44.0	111.00	6	10.00
B40014.0	14.00	160.0	47.0	115.00	6	12.50
B40016.0	16.00	170.0	52.0	125.00	6	12.50
B40018.0	18.00	182.0	56.0	137.00	6	14.00
B40020.0	20.00	195.0	60.0	147.00	6	16.00



B481



Karbidový setinový výstružník s válcovou stopkou, Leštěný

Výstružník s válcovou stopkou pro produktivní operace na CNC strojích. Setinové přírůstky průměru umožňují vytvořit přesné otvory v žádané toleranci. Karbidové břity zvyšují výkon nástroje a životnost při obrábění tvrdých a abrazivních materiálů. Extrémně nerovnoměrná zubová rozteč pro snížení vibrací.

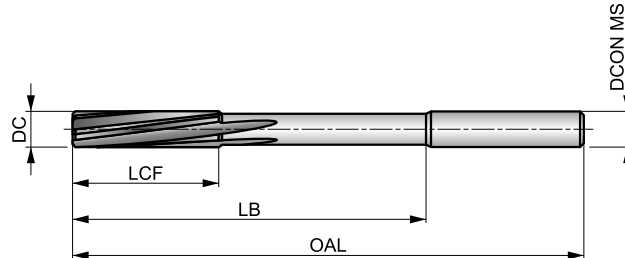

HM	Bright	DIN 8093
R	DIN 6535HA	B
$\varnothing_{95-5.5}$ $+0.004$ $\varnothing_{5.51-12}$ $+0.005$		

Skupiny obráběných materiálů, startovní řezná rychlost (Vc m/min) a kód posuvu. Tabulku s posuvem na otáčku naleznete od strany 251.

P1.1 ■ 23 B	P1.2 ■ 26 B	P1.3 ■ 27 B	P2.1 ■ 20 B	P2.2 ■ 18 B	P2.3 ■ 16 C	P3.1 ■ 16 B	P3.2 ■ 13 B	P3.3 ■ 11 C	P4.1 ■ 10 B	P4.2 ■ 8 C	P4.3 ■ 7 C	M1.1 ■ 10 C	M1.2 ■ 8 C
M2.1 ■ 9 C	M2.2 ■ 7 C	M2.3 ■ 6 B	K1.1 ■ 20 D	K1.2 ■ 15 D	K1.3 ■ 11 D	K2.1 ■ 21 D	K2.2 ■ 17 D	K2.3 ■ 14 D	K3.1 ■ 18 D	K3.2 ■ 14 D	K3.3 ■ 11 D	K5.1 ■ 19 D	K5.2 ■ 15 D
K5.3 ■ 11 D	N1.1 ■ 60 D	N1.2 ■ 45 D	N1.3 ■ 30 D	N2.1 ■ 38 D	N2.2 ■ 35 D	N2.3 ■ 25 D	N3.1 ■ 64 E	N3.2 ■ 38 E	N3.3 ■ 19 E	N4.1 ■ 35 C	N4.2 ■ 30 C		

DCON MS v toleranci h6.

Produkt	DC	OAL	LCF	LB	NOF	DCON MS
	(mm)	(mm)	(mm)	(mm)		(mm)
B4810.98	0.98	50.0	6.0	28.00	3	3.00
B4810.99	0.99	50.0	6.0	28.00	3	3.00
B4811.00	1.00	50.0	6.0	28.00	3	3.00
B4811.01	1.01	50.0	6.0	28.00	3	3.00
B4811.02	1.02	50.0	6.0	28.00	3	3.00
B4811.03	1.03	50.0	6.0	28.00	3	3.00
B4811.48	1.48	50.0	9.0	28.00	3	3.00
B4811.49	1.49	50.0	9.0	28.00	3	3.00
B4811.50	1.50	50.0	9.0	28.00	3	3.00
B4811.51	1.51	50.0	10.0	28.00	3	3.00
B4811.52	1.52	50.0	10.0	28.00	3	3.00
B4811.53	1.53	50.0	10.0	28.00	3	3.00
B4811.98	1.98	50.0	12.0	28.00	4	3.00
B4811.99	1.99	50.0	12.0	28.00	4	3.00
B4812.00	2.00	50.0	12.0	28.00	4	3.00
B4812.01	2.01	50.0	12.0	28.00	4	3.00
B4812.02	2.02	50.0	12.0	28.00	4	3.00
B4812.03	2.03	50.0	12.0	28.00	4	3.00
B4812.48	2.48	60.0	16.0	28.00	4	3.00
B4812.49	2.49	60.0	16.0	28.00	4	3.00
B4812.50	2.50	60.0	16.0	28.00	4	3.00
B4812.51	2.51	60.0	16.0	28.00	4	3.00
B4812.52	2.52	60.0	16.0	28.00	4	3.00
B4812.53	2.53	60.0	16.0	28.00	4	3.00
B4812.97	2.97	65.0	17.0	28.00	6	4.00
B4812.98	2.98	65.0	17.0	28.00	6	4.00
B4812.99	2.99	65.0	17.0	28.00	6	4.00
B4813.00	3.00	65.0	17.0	28.00	6	4.00
B4813.01	3.01	65.0	17.0	28.00	6	4.00
B4813.02	3.02	65.0	17.0	28.00	6	4.00
B4813.03	3.03	65.0	17.0	28.00	6	4.00
B4813.97	3.97	75.0	19.0	28.00	6	4.00
B4813.98	3.98	75.0	19.0	28.00	6	4.00
B4813.99	3.99	75.0	19.0	28.00	6	4.00
B4814.00	4.00	75.0	19.0	28.00	6	4.00
B4814.01	4.01	75.0	19.0	28.00	6	4.00
B4814.02	4.02	75.0	19.0	28.00	6	4.00
B4814.03	4.03	75.0	19.0	28.00	6	4.00
B4814.97	4.97	93.0	23.0	36.00	6	6.00
B4814.98	4.98	93.0	23.0	36.00	6	6.00
B4814.99	4.99	93.0	23.0	36.00	6	6.00
B4815.00	5.00	93.0	23.0	36.00	6	6.00
B4815.01	5.01	93.0	23.0	36.00	6	6.00
B4815.02	5.02	93.0	23.0	36.00	6	6.00
B4815.03	5.03	93.0	23.0	36.00	6	6.00
B4815.97	5.97	93.0	26.0	36.00	6	6.00
B4815.98	5.98	93.0	26.0	36.00	6	6.00
B4815.99	5.99	93.0	26.0	36.00	6	6.00
B4816.00	6.00	93.0	26.0	36.00	6	6.00
B4816.01	6.01	93.0	26.0	36.00	6	6.00
B4816.02	6.02	93.0	26.0	36.00	6	6.00
B4816.03	6.03	93.0	26.0	36.00	6	6.00
B4817.97	7.97	117.0	33.0	36.00	6	8.00
B4817.98	7.98	117.0	33.0	36.00	6	8.00



Produkt	DC	OAL	LCF	LB	NOF	DCON MS
	(mm)	(mm)	(mm)	(mm)		(mm)
B4817.99	7.99	117.0	33.0	36.00	6	8.00
B4818.00	8.00	117.0	33.0	36.00	6	8.00
B4818.01	8.01	117.0	33.0	36.00	6	8.00
B4818.02	8.02	117.0	33.0	36.00	6	8.00
B4818.03	8.03	117.0	33.0	36.00	6	8.00
B4818.04	8.04	117.0	33.0	36.00	6	8.00
B4819.97	9.97	133.0	38.0	40.00	6	10.00
B4819.98	9.98	133.0	38.0	40.00	6	10.00
B4819.99	9.99	133.0	38.0	40.00	6	10.00
B48110.00	10.00	133.0	38.0	40.00	6	10.00
B48110.01	10.01	133.0	38.0	40.00	6	10.00
B48110.02	10.02	133.0	38.0	40.00	6	10.00

Produkt	DC	OAL	LCF	LB	NOF	DCON MS
	(mm)	(mm)	(mm)	(mm)		(mm)
B48110.03	10.03	133.0	38.0	40.00	6	10.00
B48110.04	10.04	133.0	38.0	40.00	6	10.00
B48110.05	10.05	133.0	38.0	40.00	6	10.00
B48111.97	11.97	151.0	44.0	45.00	6	12.00
B48111.98	11.98	151.0	44.0	45.00	6	12.00
B48111.99	11.99	151.0	44.0	45.00	6	12.00
B48112.00	12.00	151.0	44.0	45.00	6	12.00
B48112.01	12.01	151.0	44.0	45.00	6	12.00
B48112.02	12.02	151.0	44.0	45.00	6	12.00
B48112.03	12.03	151.0	44.0	45.00	6	12.00
B48112.04	12.04	151.0	44.0	45.00	6	12.00
B48112.05	12.05	151.0	44.0	45.00	6	12.00



B441



Strojní výstružník s karbidovými břity a válcovou stopkou, Tolerancí H7, Leštěný

Karbidové pájené břity zvyšují výkon a prodlužují životnost. Použití k vystružení otvorů v toleranci H7. Konstruován s extrémně nerovnoměrnou zubovou roztečí pro snížení vibrací a zlepšení kruhovitosti otvorů, rozměrové přesnosti i jakosti povrchu. Produktivní nástroj pro použití na CNC strojích.

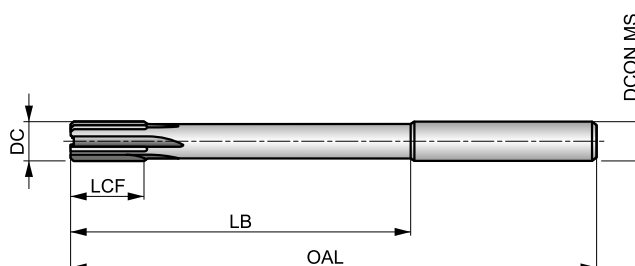

HM	Bright	DIN 8050
R		A
H7		

Skupiny obráběných materiálů, startovní řezná rychlost (Vc m/min) a kód posuvu. Tabulku s posuvem na otáčku naleznete od strany 251.

P1.1 ■ 23 B	P1.2 ■ 26 B	P1.3 ■ 27 B	P2.1 ■ 20 B	P2.2 ■ 18 B	P2.3 ■ 16 C	P3.1 ■ 16 B	P3.2 ■ 13 B	P3.3 ■ 11 C	P4.1 ■ 10 B	P4.2 ■ 8 C	P4.3 ■ 7 C	M1.1 ▣ 10 C	M1.2 ▣ 8 C
M2.1 ▣ 9 C	M2.2 ▣ 7 C	M2.3 ▣ 6 B	K1.1 ■ 20 D	K1.2 ■ 15 D	K1.3 ■ 11 D	K2.1 ■ 21 D	K2.2 ■ 17 D	K2.3 ■ 14 D	K3.1 ■ 18 D	K3.2 ■ 14 D	K3.3 ■ 11 D	K5.1 ■ 19 D	K5.2 ■ 15 D
K5.3 ■ 11 D	N1.1 ▣ 60 D	N1.2 ■ 45 D	N1.3 ■ 30 D	N2.1 ■ 38 D	N2.2 ■ 35 D	N2.3 ■ 25 D	N3.1 ■ 64 E	N3.2 ■ 38 E	N3.3 ▣ 19 E	N4.1 ▣ 35 C	N4.2 ▣ 30 C		

DCON MS v toleranci h9; hlava osazena karbidem.

Produkt	DC (mm)	OAL (mm)	LCF (mm)	LB (mm)	NOF	DCON MS (mm)
B44110.0	10.00	133.0	19.0	87.00	6	10.00
B44111.0	11.00	142.0	19.0	96.00	6	10.00
B44112.0	12.00	151.0	19.0	105.00	6	10.00
B44113.0	13.00	151.0	19.0	105.00	6	10.00
B44114.0	14.00	160.0	19.0	110.00	6	12.50
B44115.0	15.00	162.0	19.0	112.00	6	12.50
B44116.0	16.00	170.0	22.0	120.00	6	12.50
B44117.0	17.00	175.0	22.0	123.00	6	14.00
B44118.0	18.00	182.0	22.0	130.00	6	14.00
B44119.0	19.00	189.0	22.0	131.00	6	16.00
B44120.0	20.00	195.0	22.0	137.00	6	16.00



B411



Strojní výstružník s karbidovými břity a kuželovou stopkou, Tolerancí H7, Leštěný

Karbidové pájené břity zvyšují výkon a prodlužují životnost i při použití v abrazivních a tvrdých materiálech. Konstruován s extrémně nerovnoměrnou zubovou roztečí pro snížení vibrací a zlepšení kruhovitosti otvorů, rozměrové přesnosti i jakosti povrchu.

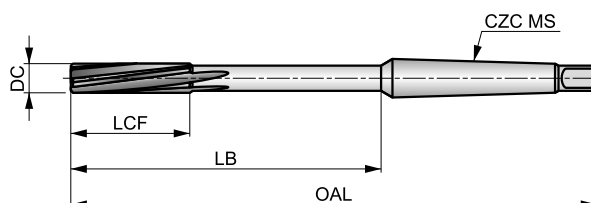

HM	Bright	DIN 8094
R		B
H7		

Skupiny obráběných materiálů, startovní řezná rychlost (Vc m/min) a kód posuvu. Tabulku s posuvem na otáčku naleznete od strany 251.

P1.1 ■ 23 B	P1.2 ■ 26 B	P1.3 ■ 27 B	P2.1 ■ 20 B	P2.2 ■ 18 B	P2.3 ■ 16 C	P3.1 ■ 16 B	P3.2 ■ 13 B	P3.3 ■ 11 C	P4.1 ■ 10 B	P4.2 ■ 8 C	P4.3 ■ 7 C	M1.1 ▣ 10 C	M1.2 ▣ 8 C
M2.1 ▣ 9 C	M2.2 ▣ 7 C	M2.3 ▣ 6 B	K1.1 ■ 20 D	K1.2 ■ 15 D	K1.3 ■ 11 D	K2.1 ■ 21 D	K2.2 ■ 17 D	K2.3 ■ 14 D	K3.1 ■ 18 D	K3.2 ■ 14 D	K3.3 ■ 11 D	K5.1 ■ 19 D	K5.2 ■ 15 D
K5.3 ■ 11 D	N1.1 ▣ 60 D	N1.2 ■ 45 D	N1.3 ■ 30 D	N2.1 ■ 38 D	N2.2 ■ 35 D	N2.3 ■ 25 D	N3.1 ■ 64 E	N3.2 ■ 38 E	N3.3 ▣ 19 E	N4.1 ▣ 35 C	N4.2 ▣ 30 C		

DC <= 16mm - karbidová hlava; DC > 16mm - osazeno karbidem.

Produkt	DC (mm)	OAL (mm)	LCF (mm)	LB (mm)	NOF	CZC MS
B4115.0	5.00	133.0	23.0	67.50	6	MK 1
B4116.0	6.00	138.0	26.0	72.50	6	MK 1
B4117.0	7.00	150.0	31.0	84.50	6	MK 1
B4118.0	8.00	156.0	33.0	90.50	6	MK 1
B4119.0	9.00	162.0	36.0	96.50	6	MK 1
B41110.0	10.00	168.0	38.0	102.50	6	MK 1
B41112.0	12.00	182.0	44.0	116.50	6	MK 1
B41114.0	14.00	189.0	47.0	123.50	8	MK 1
B41115.0	15.00	204.0	50.0	124.00	8	MK 2
B41116.0	16.00	210.0	52.0	130.00	8	MK 2
B41117.0	17.00	214.0	54.0	134.00	6	MK 2
B41118.0	18.00	219.0	56.0	139.00	6	MK 2
B41119.0	19.00	223.0	58.0	143.00	6	MK 2
B41120.0	20.00	228.0	60.0	148.00	6	MK 2
B41122.0	22.00	237.0	64.0	157.00	6	MK 2
B41124.0	24.00	268.0	68.0	169.00	8	MK 3
B41125.0	25.00	268.0	68.0	169.00	8	MK 3
B41126.0	26.00	273.0	70.0	174.00	8	MK 3
B41130.0	30.00	281.0	73.0	182.00	8	MK 3



B442



Strojní výstružník s karbidovými břity a kuželovou stopkou, Tolerance H7, Leštěný

Konstruován s extrémně nerovnoměrnou zubovou roztečí pro snížení vibrací a zlepšení kruhovitosti otvorů, rozměrové přesnosti i jakosti povrchu. Náběh 45° zajišťuje přesné středění a zlepšuje kvalitu otvoru. Karbidové pájené břity zvyšují výkon a prodlužují životnost.

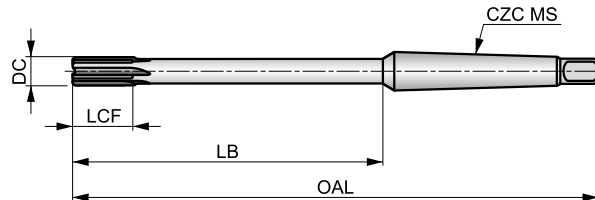

HM	Bright	DIN 8051
R		A
H7		

Skupiny obráběných materiálů, startovní řezná rychlost (Vc m/min) a kód posuvu. Tabulku s posuvem na otáčku naleznete od strany 251.

P1.1 ■ 23 B	P1.2 ■ 26 B	P1.3 ■ 27 B	P2.1 ■ 20 B	P2.2 ■ 18 B	P2.3 ■ 16 C	P3.1 ■ 16 B	P3.2 ■ 13 B	P3.3 ■ 11 C	P4.1 ■ 10 B	P4.2 ■ 8 C	P4.3 ■ 7 C	M1.1 ▣ 10 C	M1.2 ▣ 8 C
M2.1 ▣ 9 C	M2.2 ▣ 7 C	M2.3 ▣ 6 B	K1.1 ■ 20 D	K1.2 ■ 15 D	K1.3 ■ 11 D	K2.1 ■ 21 D	K2.2 ■ 17 D	K2.3 ■ 14 D	K3.1 ■ 18 D	K3.2 ■ 14 D	K3.3 ■ 11 D	K5.1 ■ 19 D	K5.2 ■ 15 D
K5.3 ■ 11 D	N1.1 ▣ 60 D	N1.2 ■ 45 D	N1.3 ■ 30 D	N2.1 ■ 38 D	N2.2 ■ 35 D	N2.3 ■ 25 D	N3.1 ■ 64 E	N3.2 ■ 38 E	N3.3 ▣ 19 E	N4.1 ▣ 35 C	N4.2 ▣ 30 C		

Produkt	DC (mm)	OAL (mm)	LCF (mm)	LB (mm)	NOF	CZC MS
B44210.0	10.00	168.0	19.0	102.50	6	MK 1
B44212.0	12.00	182.0	19.0	116.50	6	MK 1
B44214.0	14.00	189.0	19.0	123.50	6	MK 1
B44215.0	15.00	204.0	19.0	124.00	6	MK 2
B44216.0	16.00	210.0	22.0	130.00	6	MK 2
B44217.0	17.00	214.0	22.0	134.00	6	MK 2
B44218.0	18.00	219.0	22.0	139.00	6	MK 2
B44219.0	19.00	223.0	22.0	143.00	6	MK 2
B44220.0	20.00	228.0	22.0	148.00	6	MK 2



B100



HSS Ruční výstružník s válcovou stopkou a tolerancí H7, Parní temperace povrchu, Leštěný

Primárně určený k ručnímu vystružování. Pravotočivý výstružník s levotočivými břity a přesně broušenou geometrií umožňuje hladký řez, přesný rozměr otvoru a jakostní povrch. Vhodný pro širokou oblast obráběných materiálů včetně oceli.

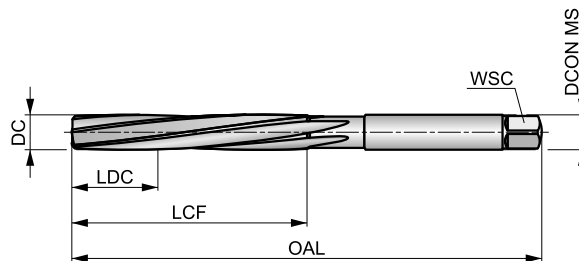

HSS	Bright ST	DIN 206
R		B
H7		

Skupiny obráběných materiálů, startovní řezná rychlost (Vc m/min) a kód posuvu. Tabulku s posuvem na otáčku naleznete od strany 251.

P1.1	P1.2	P1.3	P2.1	P2.2	P2.3	P3.1	P3.2	P3.3	P4.1	P4.2	P4.3	M1.1	M1.2
■	■	■	■	■	■	■	■	■	■	■	■	■	■
M2.1	K1.1	K1.2	K1.3	K2.1	K2.2	K2.3	K3.1	K3.2	N1.1	N1.2	N1.3	N2.1	N2.2
■	■	■	■	■	■	■	■	■	■	■	■	■	■
N2.3	N3.1	N3.2	N3.3	N4.1	N4.2								
■	■	■	■	■	■								

DCON MS v toleranci e9.

Produkt	DC (inch)	DC (mm)	OAL (mm)	LCF (mm)	LDC (mm)	NOF	WSC (mm)	DCON MS (mm)
B1001.5	–	1.50	41.0	20.0	5.00	3	1.12	1.50
B1001/16	1/16	1.59	41.0	20.0	5.00	3	1.12	1.59
B1001.6	–	1.60	44.0	21.0	5.00	3	1.25	1.60
B1005/64	5/64	1.98	47.0	23.0	6.00	4	1.40	1.98
B1002.0	–	2.00	50.0	25.0	6.00	4	1.60	2.00
B1003/32	3/32	2.38	54.0	27.0	7.00	4	1.80	2.38
B1002.5	–	2.50	58.0	29.0	7.00	4	2.10	2.50
B1007/64	7/64	2.78	62.0	31.0	8.00	6	2.10	2.78
B1003.0	–	3.00	62.0	31.0	8.00	6	2.40	3.00
B1001/8	1/8	3.18	66.0	33.0	8.00	6	2.40	3.18
B1003.2	–	3.20	66.0	33.0	8.00	6	2.40	3.20
B1003.5	–	3.50	71.0	35.0	9.00	6	2.70	3.50
B1009/64	9/64	3.57	71.0	35.0	9.00	6	2.70	3.57
B1005/32	5/32	3.97	76.0	38.0	10.00	6	3.00	3.97
B1004.0	–	4.00	76.0	38.0	10.00	6	3.00	4.00
B10011/64	11/64	4.37	81.0	41.0	10.00	6	3.40	4.37
B1004.5	–	4.50	81.0	41.0	10.00	6	3.40	4.50
B1003/16	3/16	4.76	87.0	44.0	11.00	6	3.80	4.76
B1005.0	–	5.00	87.0	44.0	11.00	6	3.80	5.00
B10013/64	13/64	5.16	87.0	44.0	11.00	6	3.80	5.16
B1005.5	–	5.50	93.0	47.0	12.00	6	4.30	5.50
B1007/32	7/32	5.56	93.0	47.0	12.00	6	4.30	5.56
B10015/64	15/64	5.95	93.0	47.0	12.00	6	4.90	5.95
B1006.0	–	6.00	93.0	47.0	12.00	6	4.90	6.00
B1001/4	1/4	6.35	100.0	50.0	13.00	6	4.90	6.35
B1006.5	–	6.50	100.0	50.0	13.00	6	4.90	6.50
B10017/64	17/64	6.75	107.0	54.0	14.00	6	5.50	6.75



Produkt	DC	DC	OAL	LCF	LDC	NOF	WSC	DCON MS
	(inch)	(mm)	(mm)	(mm)	(mm)		(mm)	(mm)
B1007.0	–	7.00	107.0	54.0	14.00	6	5.50	7.00
B1009/32	9/32	7.14	107.0	54.0	14.00	6	6.20	7.14
B1007.5	–	7.50	107.0	54.0	14.00	6	6.20	7.50
B10019/64	19/64	7.54	115.0	58.0	15.00	6	6.20	7.54
B1005/16	5/16	7.94	115.0	58.0	15.00	6	6.20	7.94
B1008.0	–	8.00	115.0	58.0	15.00	6	6.20	8.00
B10021/64	21/64	8.33	115.0	58.0	15.00	6	7.00	8.33
B1008.5	–	8.50	115.0	58.0	15.00	6	7.00	8.50
B10011/32	11/32	8.73	124.0	62.0	16.00	6	7.00	8.73
B1009.0	–	9.00	124.0	62.0	16.00	6	7.00	9.00
B10023/64	23/64	9.13	124.0	62.0	16.00	6	8.00	9.13
B1009.5	–	9.50	124.0	62.0	16.00	6	8.00	9.50
B1003/8	3/8	9.52	124.0	62.0	17.00	6	8.00	9.52
B10025/64	25/64	9.92	133.0	66.0	17.00	6	8.00	9.92
B10010.0	–	10.00	133.0	66.0	17.00	6	8.00	10.00
B10013/32	13/32	10.32	133.0	66.0	17.00	6	8.00	10.32
B10010.5	–	10.50	133.0	66.0	17.00	6	8.00	10.50
B10011.0	–	11.00	142.0	71.0	18.00	6	9.00	11.00
B1007/16	7/16	11.11	142.0	71.0	18.00	6	9.00	11.11
B10011.5	–	11.50	142.0	71.0	18.00	6	9.00	11.50
B10012.0	–	12.00	152.0	76.0	19.00	6	9.00	12.00
B10012.5	–	12.50	152.0	76.0	19.00	6	10.00	12.50
B1001/2	1/2	12.70	152.0	76.0	19.00	6	10.00	12.70
B10013.0	–	13.00	152.0	76.0	19.00	6	10.00	13.00
B10017/32	17/32	13.49	163.0	81.0	20.00	8	11.00	13.49
B10013.5	–	13.50	163.0	81.0	20.00	8	11.00	13.50
B10014.0	–	14.00	163.0	81.0	20.00	8	11.00	14.00
B1009/16	9/16	14.29	163.0	81.0	20.00	8	11.00	14.29
B10014.5	–	14.50	163.0	81.0	20.00	8	11.00	14.50
B10015.0	–	15.00	163.0	81.0	20.00	8	12.00	15.00
B10019/32	19/32	15.08	163.0	81.0	22.00	8	12.00	15.08
B1005/8	5/8	15.88	175.0	87.0	22.00	8	12.00	15.88
B10016.0	–	16.00	175.0	87.0	22.00	8	12.00	16.00
B10017.0	–	17.00	175.0	87.0	22.00	8	13.00	17.00
B10011/16	11/16	17.46	188.0	93.0	23.00	8	14.50	17.46
B10018.0	–	18.00	188.0	93.0	23.00	8	14.50	18.00
B10019.0	–	19.00	188.0	93.0	23.00	8	14.50	19.00
B1003/4	3/4	19.05	188.0	93.0	25.00	8	14.50	19.05
B10020.0	–	20.00	201.0	100.0	25.00	8	16.00	20.00
B10013/16	13/16	20.64	201.0	100.0	25.00	8	16.00	20.64
B10021.0	–	21.00	201.0	100.0	25.00	8	16.00	21.00
B10022.0	–	22.00	215.0	107.0	27.00	8	18.00	22.00
B1007/8	7/8	22.22	215.0	107.0	27.00	8	18.00	22.22
B10023.0	–	23.00	215.0	107.0	27.00	8	18.00	23.00
B10024.0	–	24.00	231.0	115.0	29.00	8	18.00	24.00
B10025.0	–	25.00	231.0	115.0	29.00	8	20.00	25.00
B1001	1"	25.40	231.0	115.0	29.00	8	20.00	25.40
B10026.0	–	26.00	231.0	115.0	29.00	8	20.00	26.00
B10027.0	–	27.00	247.0	124.0	31.00	10	22.00	27.00
B10028.0	–	28.00	247.0	124.0	31.00	10	22.00	28.00
B10029.0	–	29.00	247.0	124.0	31.00	10	22.00	29.00
B10030.0	–	30.00	247.0	124.0	31.00	10	24.00	30.00
B10031.0	–	31.00	265.0	133.0	33.00	10	24.00	31.00
B10032.0	–	32.00	265.0	133.0	33.00	10	24.00	32.00
B10033.0	–	33.00	265.0	133.0	33.00	10	26.00	33.00
B10034.0	–	34.00	284.0	142.0	36.00	10	26.00	34.00
B10035.0	–	35.00	284.0	142.0	36.00	10	29.00	35.00
B10036.0	–	36.00	284.0	142.0	36.00	10	29.00	36.00
B10037.0	–	37.00	284.0	142.0	36.00	10	29.00	37.00
B10038.0	–	38.00	305.0	152.0	38.00	10	29.00	38.00
B10039.0	–	39.00	305.0	152.0	38.00	10	32.00	39.00
B10040.0	–	40.00	305.0	152.0	38.00	10	32.00	40.00
B10045.0	–	45.00	326.0	163.0	41.00	12	35.00	45.00
B10050.0	–	50.00	347.0	174.0	44.00	12	39.00	50.00



B334



HSS Stavitelný ruční výstružník s válcovou stopkou

Snadno stavitelný ruční výstružník umožňuje dokončení různých průměrů otvorů jedním výstružníkem. Přesně broušené rovné břity pro hladký řez a zlepšení rozměrové přesnosti a jakosti povrchu. Vhodný pro širokou oblast obráběných materiálů.

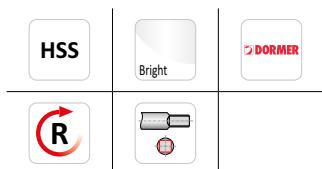
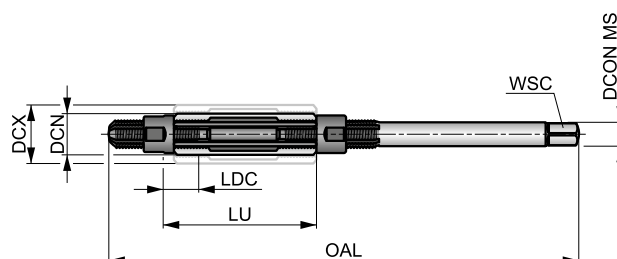

Skupiny obráběných materiálů, startovní řezná rychlost (Vc m/min) a kód posuvu. Tabulku s posuvem na otáčku naleznete od strany 251.

P1.1	P1.2	P1.3	P2.1	P2.2	P2.3	P3.1	P3.2	P3.3	P4.1	P4.2	P4.3	M1.1	M1.2
■	■	■	■	■	■	■	■	■	■	■	■	■	■
M2.1	K1.1	K1.2	K1.3	K2.1	K2.2	K2.3	K3.1	K3.2	N1.1	N1.2	N1.3	N2.1	N2.2
■	■	■	■	■	■	■	■	■	■	■	■	■	■
N2.3	N3.1	N3.2	N3.3	N4.1	N4.2								
■	■	■	■	■	■								

Produkt	Nr.	DCN	DCX	OAL	LU	LDC	NOF	WSC
		(mm)	(mm)	(mm)	(mm)	(mm)		
B334000	000	6.40	7.20	110.0	32.00	7.00	4	3.00
B33400	00	7.20	8.00	110.0	32.00	7.00	4	3.40
B3340	0	8.00	9.00	115.0	34.00	9.00	5	3.80
B3341	1	9.00	10.00	115.0	34.00	9.00	5	4.30
B3342	2	10.00	11.00	115.0	34.00	9.00	5	4.90
B3343	3	11.00	12.00	125.0	35.00	9.00	5	4.90
B3344	4	12.00	13.50	135.0	41.00	9.00	5	6.20
B3345	5	13.50	15.50	146.0	50.00	12.00	5	7.00
B3346	6	15.50	18.00	166.0	60.00	12.00	5	8.00
B3347	7	18.00	21.00	178.0	65.00	15.00	5	9.00
B3348	8	21.00	24.00	195.0	76.00	15.00	5	11.00
B3349	9	24.00	27.50	218.0	82.00	18.00	5	12.00
B33410	10	27.50	31.50	245.0	86.00	18.00	5	14.50
B33411	11	31.50	37.00	280.0	98.00	18.00	6	18.00
B33412	12	37.00	45.00	325.0	108.00	20.00	6	20.00
B33413	13	45.00	55.00	370.0	118.00	20.00	6	26.00
B33414	14	55.00	67.00	400.0	125.00	20.00	6	32.00
B33415	15	67.00	80.00	435.0	140.00	23.00	8	39.00
B33416	16	80.00	95.00	475.0	155.00	23.00	8	49.00



B335

DORMER



Náhradní matice a břity pro nastavitelný ruční výstružník B334

Matice a břity mohou být objednávány zvlášť a jsou nabízeny v 19 rozměrech.

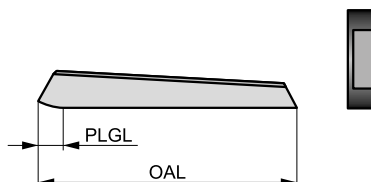

Produkt	Nr.	PLGL	OAL
		(mm)	(mm)
B335000BLADES	000	7.00	32.0
B335000NUT	000	–	–
B33500BLADES	00	7.00	32.0
B33500NUT	00	–	–
B3350BLADES	0	9.00	34.0
B3350NUT	0	–	–
B3351BLADES	1	9.00	34.0
B3351NUT	1	–	–
B3352BLADES	2	9.00	34.0
B3352NUT	2	–	–
B3353BLADES	3	9.00	35.0
B3353NUT	3	–	–
B3354BLADES	4	9.00	41.0
B3354NUT	4	–	–
B3355BLADES	5	12.00	50.0
B3355NUT	5	–	–
B3356BLADES	6	12.00	60.0
B3356NUT	6	–	–
B3357BLADES	7	15.00	65.0

Produkt	Nr.	PLGL	OAL
		(mm)	(mm)
B3357NUT	7	–	–
B3358BLADES	8	15.00	76.0
B3358NUT	8	–	–
B3359BLADES	9	18.00	82.0
B3359NUT	9	–	–
B33510BLADES	10	18.00	86.0
B33510NUT	10	–	–
B33511BLADES	11	18.00	98.0
B33511NUT	11	–	–
B33512BLADES	12	20.00	108.0
B33512NUT	12	–	–
B33513BLADES	13	20.00	118.0
B33513NUT	13	–	–
B33514BLADES	14	20.00	125.0
B33514NUT	14	–	–
B33515BLADES	15	23.00	140.0
B33515NUT	15	–	–
B33516BLADES	16	23.00	155.0
B33516NUT	16	–	–



B901



HSS-E Strojní výstružník s válcovou stopkou, Tolerance H7, Leštěný, Parní temperace povrchu

Přesně broušený pravotočivý výstružník s levotočivou spirálou pro zlepšení rozměrové přesnosti i jakosti povrchu. Výstružník má válcovou stopku pro produktivní strojní použití. Vhodný pro širokou oblast obráběných materiálů.

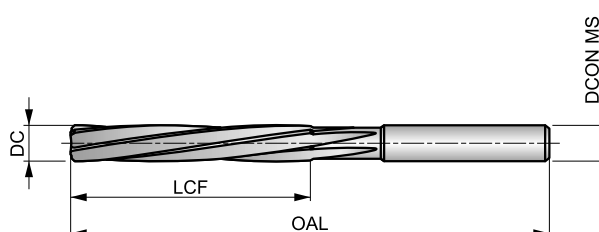

HSS-E	Bright ST	BS 328
R		B
H7		

Skupiny obráběných materiálů, startovní řezná rychlost (Vc m/min) a kód posuvu. Tabulku s posuvem na otáčku naleznete od strany 251.

P1.1 ■ 15 C	P1.2 ■ 16 C	P1.3 ■ 17 C	P2.1 ■ 13 C	P2.2 ■ 11 C	P2.3 ▧ 10 B	P3.1 ■ 7 B	P3.2 ■ 6 B	P3.3 ▧ 5 B	P4.1 ■ 4 B	P4.2 ▧ 4 B	P4.3 ▧ 3 A	M1.1 ▧ 10 C	M1.2 ▧ 8 C
M2.1 ▧ 9 C	K1.1 ■ 14 E	K1.2 ■ 10 D	K1.3 ▧ 8 D	K2.1 ■ 12 C	K2.2 ■ 10 C	K2.3 ▧ 8 C	K3.1 ▧ 11 C	K3.2 ▧ 8 C	N1.1 ▧ 23 F	N1.2 ■ 17 F	N1.3 ■ 12 F	N2.1 ■ 25 E	N2.2 ■ 22 E
N2.3 ▧ 14 E	N3.1 ■ 34 D	N3.2 ■ 20 E	N3.3 ■ 10 D	N4.1 ▧ 22 B	N4.2 ▧ 21 B								

Produkt	DC	DC	OAL	LCF	NOF	DCON MS
	(inch)	(mm)	(mm)	(mm)	(mm)	(mm)
B9011.5	–	1.50	44.0	21.0	4	1.50
B9011/16	1/16	1.59	44.0	21.0	4	1.59
B9012.0	–	2.00	50.0	25.0	4	2.00
B9013/32	3/32	2.38	58.0	29.0	4	2.38
B9012.5	–	2.50	58.0	29.0	4	2.50
B9013.0	–	3.00	62.0	31.0	4	3.00
B9011/8	1/8	3.18	66.0	33.0	4	3.18
B9013.5	–	3.50	71.0	35.0	4	3.50
B9015/32	5/32	3.97	76.0	38.0	6	3.97
B9014.0	–	4.00	76.0	38.0	6	4.00
B9014.5	–	4.50	81.0	41.0	6	4.50
B9013/16	3/16	4.76	87.0	44.0	6	4.76
B9015.0	–	5.00	87.0	44.0	6	5.00
B90113/64	13/64	5.16	87.0	44.0	6	5.16
B9015.5	–	5.50	93.0	47.0	6	5.50

Produkt	DC	DC	OAL	LCF	NOF	DCON MS
	(inch)	(mm)	(mm)	(mm)	(mm)	(mm)
B9017/32	7/32	5.56	93.0	47.0	6	5.56
B90115/64	15/64	5.95	93.0	47.0	6	5.95
B9016.0	–	6.00	93.0	47.0	6	6.00
B9011/4	1/4	6.35	100.0	50.0	6	6.35
B9017.0	–	7.00	107.0	54.0	6	7.00
B9019/32	9/32	7.14	107.0	54.0	6	7.14
B9015/16	5/16	7.94	115.0	58.0	6	7.94
B9018.0	–	8.00	115.0	58.0	6	8.00
B9019.0	–	9.00	124.0	62.0	6	9.00
B9013/8	3/8	9.52	133.0	66.0	6	9.52
B90110.0	–	10.00	133.0	66.0	6	10.00
B90111.0	–	11.00	142.0	71.0	6	11.00
B9017/16	7/16	11.11	142.0	71.0	6	11.11
B90112.0	–	12.00	152.0	76.0	6	12.00
B9011/2	1/2	12.70	152.0	76.0	6	12.70



B301



HSS Ruční výstružník na kuželové kolíky s kuzelem 1:48, Leštěný, Parní temperace povrchu

Výstružník konstruovaný pro dokončování kuželových otvorů s konusem 1:48 (palcové míry kuželových kolíků). Zúžený malý průměr usnadňuje usazení a vystředění v předvrtaném otvoru, zlepšuje výkon a přesnost otvoru. Vhodný pro vystružování mnoha materiálů.

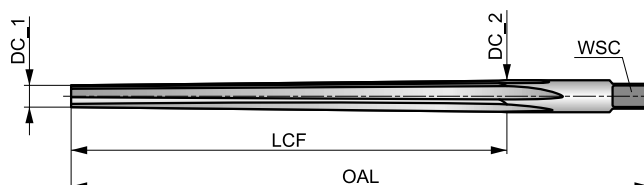

HSS	Bright ST	BS 328
R		A
1:48		

Skupiny obráběných materiálů, startovní rezná rychlost (Vc m/min) a kód posuvu. Tabulku s posuvem na otáčku naleznete od strany 251.

P1.1	P1.2	P1.3	P2.1	P2.2	P2.3	P3.1	P3.2	P3.3	P4.1	P4.2	P4.3	M1.1	M1.2
■	■	■	■	■	■	■	■	■	■	■	■	■	■
M2.1	K1.1	K1.2	K1.3	K2.1	K2.2	K2.3	K3.1	K3.2	N1.1	N1.2	N1.3	N2.1	N2.2
■	■	■	■	■	■	■	■	■	■	■	■	■	■
N2.3	N3.1	N3.2	N3.3	N4.1	N4.2								
■	■	■	■	■	■								

DC <= 1/4 mez tolerance +0.0030; DC >= 9/32 mez tolerance +0.0050.

Produkt	nom d	DC_1	DC_2	OAL	LCF	NOF	WSC	DCON MS
		(mm)	(mm)	(mm)	(mm)		(mm)	(mm)
B3011/16	1/16	1.10	1.63	51.0	25.0	4	1.20	1.63
B3015/64	5/64	1.50	2.03	51.0	25.0	4	1.60	2.03
B3013/32	3/32	1.75	2.41	57.0	32.0	4	2.00	2.41
B3017/64	7/64	2.03	2.82	64.0	38.0	4	2.20	2.82
B3011/8	1/8	2.30	3.23	70.0	44.0	4	2.50	3.23
B3019/64	9/64	2.64	3.63	73.0	48.0	4	2.80	3.63
B3015/32	5/32	2.95	4.01	76.0	51.0	4	3.10	4.01
B30111/64	11/64	3.23	4.42	89.0	57.0	4	3.60	4.42
B3013/16	3/16	3.50	4.95	102.0	70.0	4	4.00	4.95
B3017/32	7/32	4.13	5.59	102.0	70.0	6	4.50	5.59
B3011/4	1/4	4.64	6.43	117.0	86.0	6	5.00	6.43
B3019/32	9/32	5.23	7.42	143.0	105.0	6	5.60	7.42
B3015/16	5/16	5.84	8.03	143.0	105.0	6	6.30	8.03
B30111/32	11/32	6.43	8.81	152.0	114.0	6	7.10	8.81
B3013/8	3/8	7.03	9.68	165.0	127.0	6	8.00	9.68
B30113/32	13/32	7.42	10.46	191.0	146.0	6	8.00	10.46
B3017/16	7/16	8.21	11.25	191.0	146.0	6	9.00	11.25
B3011/2	1/2	9.41	12.85	210.0	165.0	6	10.00	12.85



B903



HSS Ruční výstružník na kuželové kolíky s kuželem 1:50, Leštěný, Parní temperace povrchu

Výstružník konstruovaný pro dokončování kuželových otvorů s kuželem 1:50 (metrické míry kuželových kolíků). Zúžený malý průměr usnadňuje usazení a vystředění v předvrtaném otvoru, zlepšuje výkon a přesnost otvoru. Vhodný pro vystružování mnoha materiálů.

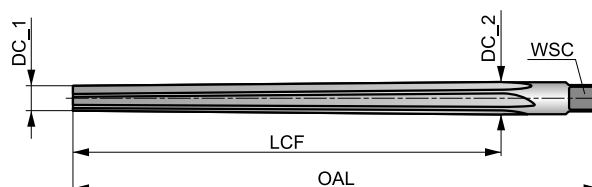

HSS	Bright ST	DIN 9
R		A
1:50		

Skupiny obráběných materiálů, startovní řezná rychlost (Vc m/min) a kód posuvu. Tabulku s posuvem na otáčku naleznete od strany 251.

P1.1	P1.2	P1.3	P2.1	P2.2	P2.3	P3.1	P3.2	P3.3	P4.1	P4.2	P4.3	M1.1	M1.2
■	■	■	■	■	■	■	■	■	■	■	■	■	■
M2.1	K1.1	K1.2	K1.3	K2.1	K2.2	K2.3	K3.1	K3.2	N1.1	N1.2	N1.3	N2.1	N2.2
■	■	■	■	■	■	■	■	■	■	■	■	■	■
N2.3	N3.1	N3.2	N3.3	N4.1	N4.2								
■	■	■	■	■	■								

DCON MS v toleranci h11; DC <= 5mm mez tolerance +0.0750; DC < 5mm mez tolerance +0.1250.

Produkt	nom d	DC_1	DC_2	OAL	LCF	NOF	WSC	DCON MS
		(mm)	(mm)	(mm)	(mm)		(mm)	(mm)
B9031.5	1.5	1.40	2.14	57.0	37.0	4	1.80	2.14
B9032.0	2.0	1.90	2.86	68.0	48.0	4	2.24	2.86
B9032.5	2.5	2.40	3.36	68.0	48.0	4	2.80	3.36
B9033.0	3.0	2.90	4.06	80.0	58.0	4	3.15	4.00
B9034.0	4.0	3.90	5.26	93.0	68.0	4	4.00	5.00
B9035.0	5.0	4.90	6.36	100.0	73.0	4	5.00	6.30
B9036.0	6.0	5.90	8.00	135.0	105.0	6	6.30	7.90
B9038.0	8.0	7.90	10.80	180.0	145.0	6	8.00	10.50
B90310.0	10.0	9.90	13.40	215.0	175.0	6	10.00	13.30
B90312.0	12.0	11.80	16.00	255.0	210.0	8	11.20	16.00
B90313.0	13.0	12.86	16.74	255.0	210.0	8	12.50	16.74
B90314.0	14.0	13.86	17.74	255.0	210.0	8	12.50	17.74
B90316.0	16.0	15.80	20.40	280.0	230.0	8	14.00	20.40
B90320.0	20.0	19.80	24.80	310.0	250.0	8	18.00	24.80



B952

HSS Ruční výstružník na kuželové kolíky s kuzelem 1:50, Leštěný

Výstružník pravotočivý s levotočivou šroubovicí pro hladký řez, přesnější otvor a lepší jakost povrchu. Zúžený náběh usnadňuje usazení a vystředění v předvrtaném otvoru. Vhodný pro vystružování mnoha materiálů.

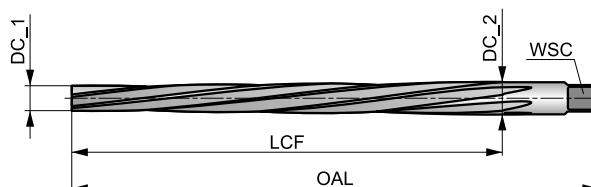

HSS	Bright	DIN 9
R		B
1:50		

Skupiny obráběných materiálů, startovní řezná rychlost (Vc m/min) a kód posuvu. Tabulku s posuvem na otáčku naleznete od strany 251.

P1.1	P1.2	P1.3	P2.1	P2.2	P2.3	P3.1	P3.2	P3.3	P4.1	P4.2	P4.3	M1.1	M1.2
■	■	■	■	■	■	■	■	■	■	■	■	■	■
M2.1	K1.1	K1.2	K1.3	K2.1	K2.2	K2.3	K3.1	K3.2	N1.1	N1.2	N1.3	N2.1	N2.2
■	■	■	■	■	■	■	■	■	■	■	■	■	■
N2.3	N3.1	N3.2	N3.3	N4.1	N4.2								
■	■	■	■	■	■								

DCON MS v toleranci h11; DC <= 2.5mm rovná drážka, tvar A.

Produkt	nom d	DC_1	DC_2	OAL	LCF	NOF	WSC	DCON MS
		(mm)	(mm)					
B9521.2	1.2	1.10	1.74	50.0	32.0	3	2.40	3.15
B9521.5	1.5	1.40	2.14	57.0	37.0	3	2.40	3.15
B9522.0	2.0	1.90	2.86	68.0	48.0	3	2.40	3.15
B9522.5	2.5	2.40	3.36	68.0	48.0	4	2.40	3.15
B9523.0	3.0	2.90	4.06	80.0	58.0	5	3.00	4.00
B9523.5	3.5	3.40	4.66	87.0	63.0	5	3.40	4.50
B9524.0	4.0	3.90	5.26	93.0	68.0	5	3.80	5.00
B9524.5	4.5	4.40	5.80	95.0	70.0	5	4.30	5.60
B9525.0	5.0	4.90	6.36	100.0	73.0	5	4.90	6.30
B9525.5	5.5	5.40	7.20	118.0	90.0	6	5.50	7.10
B9526.0	6.0	5.90	8.00	135.0	105.0	6	6.20	8.00
B9526.5	6.5	6.40	8.60	140.0	110.0	6	6.20	8.00
B9527.0	7.0	6.90	9.40	160.0	125.0	6	7.00	9.00
B9528.0	8.0	7.90	10.80	180.0	145.0	6	8.00	10.00
B9529.0	9.0	8.90	12.10	195.0	160.0	6	9.00	11.20
B95210.0	10.0	9.90	13.40	215.0	175.0	6	10.00	12.50
B95212.0	12.0	11.80	16.00	255.0	210.0	8	11.00	14.00
B95213.0	13.0	12.80	17.00	255.0	210.0	8	12.00	16.00
B95214.0	14.0	13.80	18.00	255.0	210.0	8	12.00	16.00
B95216.0	16.0	15.80	20.40	280.0	230.0	8	14.50	18.00
B95220.0	20.0	19.80	24.80	310.0	250.0	8	18.00	22.40
B95225.0	25.0	24.70	30.70	370.0	300.0	10	22.00	28.00
B95230.0	30.0	29.70	36.10	400.0	320.0	10	24.00	31.50
B95240.0	40.0	39.70	46.50	430.0	340.0	12	32.00	40.00
B95250.0	50.0	49.70	56.90	460.0	360.0	12	39.00	50.00



B122



HSS Kuželový ruční výstružník se zúženou stopkou, Parní temperace povrchu a Bronz

Konstruován pro sestružení otvorů u tenkostěnných plechových dílů před sešroubováním či snýtváním. Malý náběh s kuzelem 1:10 usnadňuje sestružení předvrtaných otvorů. Vhodný pro širokou oblast obráběných materiálů.

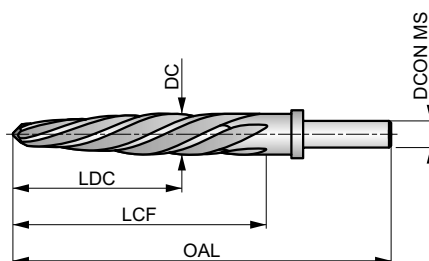

HSS	ST Bronze	ANSI
R		

Skupiny obráběných materiálů, startovní řezná rychlost (Vc m/min) a kód posuvu. Tabulku s posuvem na otáčku naleznete od strany 251.

P1.1 ■ 15 C	P1.2 ■ 16 C	P1.3 ■ 17 C	P2.1 ■ 13 C	P2.2 ■ 11 C	P3.1 ■ 7 B	M1.1 ■ 11 C	M1.2 ■ 10 B	M2.1 ■ 9 B	N1.1 ■ 23 F	N1.2 ■ 17 F	N2.1 ■ 23 E	N2.2 ■ 21 E	N3.1 ■ 34 D
N3.2 ■ 20 E	N4.1 ■ 22 B	N4.2 ■ 21 B											

Produkt	DC (inch)	DC (inch)	OAL (inch)	LCF (inch)	NOF	DCONMS (inch)
B1223/8	3/8	0.3750	4.5/8	2.1/2	4	3/8
B1221/2	1/2	0.5000	5.7/8	3.3/4	5	1/2
B1229/16	9/16	0.5625	5.7/8	3.3/4	5	1/2
B1225/8	5/8	0.6250	6.3/8	4.1/4	5	1/2
B12211/16	11/16	0.6875	6.3/8	4.1/4	5	1/2
B1223/4	3/4	0.7500	6.7/8	4.1/2	5	1/2
B12213/16	13/16	0.8125	6.7/8	4.1/2	5	1/2
B1227/8	7/8	0.8750	6.7/8	4.1/2	5	1/2
B12215/16	15/16	0.9375	6.7/8	4.1/2	5	1/2
B1221	1"	1.0000	6.7/8	4.1/2	5	1/2
B1221.1/16	1.1/16	1.0625	6.7/8	4.1/2	5	1/2



B953



HSS-E Ruční výstružník na kuželové kolíky s kuzelem 1:50, Leštěný

Výstružník pravotočivý s malým úhlem levotočivé šroubovice. Konstruovaný pro dokončování kuželových otvorů s kuzelem 1:50 (metrické míry kuželových kolíků). Zúžený náběh usnadňuje vystředění a zlepšuje produktivitu. Vhodný pro vystružování mnoha materiálů.

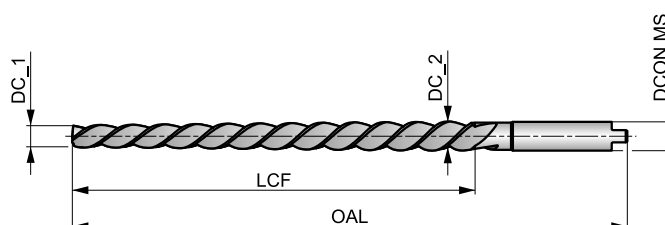

HSS-E	Bright	DIN 2179
R		1:50

Skupiny obráběných materiálů, startovní řezná rychlost (Vc m/min) a kód posuvu. Tabulku s posuvem na otáčku naleznete od strany 251.

P1.1 ■ 10 B	P1.2 ■ 12 B	P1.3 ■ 13 B	P2.1 ■ 9 B	P2.2 ■ 8 B	P2.3 ▣ 6 A	P3.1 ■ 7 A	P3.2 ▣ 6 A	P3.3 ▣ 3 A	P4.1 ■ 4 A	P4.2 ▣ 3 A	P4.3 ▣ 2 A	M1.1 ▣ 11 C	M1.2 ▣ 10 B
M2.1 ▣ 9 B	M2.2 ▣ 8 B	K1.1 ■ 10 C	K1.2 ■ 6 B	K1.3 ▣ 4 B	K2.1 ■ 8 A	K2.2 ■ 6 A	K2.3 ▣ 4 A	K3.1 ■ 7 A	K3.2 ▣ 4 A	N1.1 ▣ 14 D	N1.2 ■ 12 D	N1.3 ■ 9 D	N2.1 ■ 16 C
N2.2 ■ 14 C	N2.3 ▣ 10 C	N3.1 ■ 22 B	N3.2 ■ 14 C	N3.3 ▣ 6 B	N4.1 ▣ 22 B								

DCON MS v toleranci h9.

Produkt	nom d	DC_1	DC_2	OAL	LCF	NOF	DCON MS
		(mm)	(mm)	(mm)	(mm)		(mm)
B9531.0	1.0	0.80	1.46	60.0	33.0	2	1.40
B9531.5	1.5	1.40	2.14	70.0	37.0	2	2.10
B9532.0	2.0	1.90	2.86	86.0	48.0	3	3.15
B9532.5	2.5	2.40	3.36	86.0	48.0	3	3.15
B9533.0	3.0	2.90	4.06	100.0	58.0	3	4.00
B9534.0	4.0	3.90	5.26	112.0	68.0	3	5.00
B9535.0	5.0	4.90	6.36	122.0	73.0	3	6.30
B9536.0	6.0	5.90	8.00	160.0	105.0	3	8.00
B9536.5	6.5	6.40	8.78	188.0	119.0	3	8.50
B9538.0	8.0	7.90	10.80	207.0	145.0	3	10.00
B95310.0	10.0	9.90	13.40	245.0	175.0	3	12.50
B95312.0	12.0	11.80	16.00	290.0	210.0	3	16.00



B180



HSS-E Strojní výstružník s tolerancí H7 a válcovou stopkou, Leštěný

Vysoce produktivní výstružník pro CNC stroje a upínání do přesných upínačů a kleštin. Přesně broušené levotočivé drážky na pravotočivém výstružníku umožňují hladký řez a zlepšují jakost povrchu a přesnost otvoru. Vhodný pro širokou oblast obráběných materiálů.

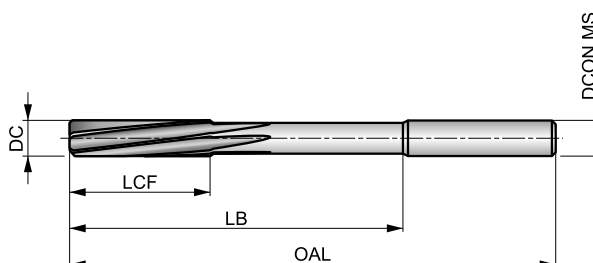

HSS-E	Bright	DIN 212
R	DIN 6535HA	B
H7		

Skupiny obráběných materiálů, startovní řezná rychlost (Vc m/min) a kód posuvu. Tabulku s posuvem na otáčku naleznete od strany 251.

P1.1 ■ 21 C	P1.2 ■ 24 C	P1.3 ■ 25 C	P2.1 ■ 18 C	P2.2 ■ 16 C	P2.3 ■ 14 B	P3.1 ■ 13 B	P3.2 ■ 11 B	P3.3 ■ 9 B	P4.1 ■ 8 B	P4.2 ■ 7 B	P4.3 ■ 5 A	M1.1 ■ 11 C	M1.2 ■ 10 B
M2.1 ■ 9 B	K1.1 ■ 16 E	K1.2 ■ 12 D	K1.3 ■ 9 D	K2.1 ■ 16 C	K2.2 ■ 13 C	K2.3 ■ 10 C	K3.1 ■ 14 C	K3.2 ■ 11 C	N1.1 ■ 24 F	N1.2 ■ 18 F	N1.3 ■ 11 F	N2.1 ■ 27 E	N2.2 ■ 24 E
N2.3 ■ 16 E	N3.1 ■ 47 D	N3.2 ■ 28 E	N3.3 ■ 14 D	N4.1 ■ 30 B									

DCON MS v toleranci h6.

Produkt	DC (mm)	OAL (mm)	LCF (mm)	LB (mm)	NOF	DCON MS (mm)
B1801.5	1.50	40.0	8.0	18.00	3	2.00
B1801.6	1.60	43.0	9.0	20.00	3	2.00
B1801.7	1.70	43.0	9.0	20.00	3	2.00
B1801.8	1.80	46.0	10.0	22.00	4	2.00
B1801.9	1.90	46.0	10.0	22.00	4	2.00
B1802.0	2.00	49.0	11.0	24.00	4	2.00
B1802.1	2.10	49.0	11.0	24.00	4	2.00
B1802.2	2.20	53.0	12.0	26.00	4	3.00
B1802.3	2.30	53.0	12.0	26.00	4	3.00
B1802.4	2.40	57.0	14.0	28.00	4	3.00
B1802.5	2.50	57.0	14.0	28.00	4	3.00
B1802.6	2.60	57.0	14.0	28.00	4	3.00
B1802.7	2.70	61.0	15.0	32.00	6	3.00
B1802.8	2.80	61.0	15.0	32.00	6	3.00
B1802.9	2.90	61.0	15.0	32.00	6	3.00
B1803.0	3.00	61.0	15.0	32.00	6	3.00
B1803.1	3.10	65.0	16.0	35.00	6	4.00
B1803.2	3.20	65.0	16.0	35.00	6	4.00
B1803.3	3.30	65.0	16.0	35.00	6	4.00
B1803.4	3.40	70.0	18.0	40.00	6	4.00
B1803.5	3.50	70.0	18.0	40.00	6	4.00
B1803.6	3.60	70.0	18.0	40.00	6	4.00
B1803.7	3.70	70.0	18.0	40.00	6	4.00
B1803.8	3.80	75.0	19.0	43.00	6	4.00
B1803.9	3.90	75.0	19.0	43.00	6	4.00
B1804.0	4.00	75.0	19.0	43.00	6	4.00
B1804.1	4.10	75.0	19.0	43.00	6	4.00

Produkt	DC (mm)	OAL (mm)	LCF (mm)	LB (mm)	NOF	DCON MS (mm)
B1804.2	4.20	75.0	19.0	43.00	6	4.00
B1804.3	4.30	80.0	21.0	47.00	6	5.00
B1804.4	4.40	80.0	21.0	47.00	6	5.00
B1804.5	4.50	80.0	21.0	47.00	6	5.00
B1804.6	4.60	80.0	21.0	47.00	6	5.00
B1804.7	4.70	80.0	21.0	47.00	6	5.00
B1804.8	4.80	86.0	23.0	52.00	6	5.00
B1804.9	4.90	86.0	23.0	52.00	6	5.00
B1805.0	5.00	86.0	23.0	52.00	6	5.00
B1805.1	5.10	86.0	23.0	52.00	6	5.00
B1805.2	5.20	86.0	23.0	52.00	6	5.00
B1805.3	5.30	86.0	23.0	52.00	6	5.00
B1805.4	5.40	93.0	26.0	57.00	6	6.00
B1805.5	5.50	93.0	26.0	57.00	6	6.00
B1805.6	5.60	93.0	26.0	57.00	6	6.00
B1805.7	5.70	93.0	26.0	57.00	6	6.00
B1805.8	5.80	93.0	26.0	57.00	6	6.00
B1805.9	5.90	93.0	26.0	57.00	6	6.00
B1806.0	6.00	93.0	26.0	57.00	6	6.00
B1806.1	6.10	101.0	28.0	63.00	6	6.00
B1806.2	6.20	101.0	28.0	63.00	6	6.00
B1806.3	6.30	101.0	28.0	63.00	6	6.00
B1806.4	6.40	101.0	28.0	63.00	6	6.00
B1806.5	6.50	101.0	28.0	63.00	6	6.00
B1806.6	6.60	101.0	28.0	63.00	6	6.00
B1806.7	6.70	101.0	28.0	63.00	6	6.00
B1806.8	6.80	109.0	31.0	69.00	6	8.00



Produkt	DC	OAL	LCF	LB	NOF	DCON MS
	(mm)	(mm)	(mm)	(mm)		(mm)
B1806.9	6.90	109.0	31.0	69.00	6	8.00
B1807.0	7.00	109.0	31.0	69.00	6	8.00
B1807.1	7.10	109.0	31.0	69.00	6	8.00
B1807.2	7.20	109.0	31.0	69.00	6	8.00
B1807.3	7.30	109.0	31.0	69.00	6	8.00
B1807.4	7.40	109.0	31.0	69.00	6	8.00
B1807.5	7.50	109.0	31.0	69.00	6	8.00
B1807.6	7.60	117.0	33.0	75.00	6	8.00
B1807.7	7.70	117.0	33.0	75.00	6	8.00
B1807.8	7.80	117.0	33.0	75.00	6	8.00
B1807.9	7.90	117.0	33.0	75.00	6	8.00
B1808.0	8.00	117.0	33.0	75.00	6	8.00
B1808.1	8.10	117.0	33.0	75.00	6	8.00
B1808.2	8.20	117.0	33.0	75.00	6	8.00
B1808.3	8.30	117.0	33.0	75.00	6	8.00
B1808.4	8.40	117.0	33.0	75.00	6	8.00
B1808.5	8.50	117.0	33.0	75.00	6	8.00
B1808.6	8.60	125.0	36.0	81.00	6	10.00
B1808.7	8.70	125.0	36.0	81.00	6	10.00
B1808.8	8.80	125.0	36.0	81.00	6	10.00
B1808.9	8.90	125.0	36.0	81.00	6	10.00

Produkt	DC	OAL	LCF	LB	NOF	DCON MS
	(mm)	(mm)	(mm)	(mm)		(mm)
B1809.0	9.00	125.0	36.0	81.00	6	10.00
B1809.1	9.10	125.0	36.0	81.00	6	10.00
B1809.2	9.20	125.0	36.0	81.00	6	10.00
B1809.3	9.30	125.0	36.0	81.00	6	10.00
B1809.4	9.40	125.0	36.0	81.00	6	10.00
B1809.5	9.50	125.0	36.0	81.00	6	10.00
B1809.6	9.60	133.0	38.0	87.00	6	10.00
B1809.7	9.70	133.0	38.0	87.00	6	10.00
B1809.8	9.80	133.0	38.0	87.00	6	10.00
B1809.9	9.90	133.0	38.0	87.00	6	10.00
B18010.0	10.00	133.0	38.0	87.00	6	10.00
B18011.0	11.00	142.0	41.0	96.00	6	10.00
B18012.0	12.00	151.0	44.0	105.00	6	10.00
B18013.0	13.00	151.0	44.0	105.00	6	10.00
B18014.0	14.00	160.0	47.0	110.00	8	14.00
B18015.0	15.00	162.0	50.0	112.00	8	14.00
B18016.0	16.00	170.0	52.0	120.00	8	14.00
B18017.0	17.00	175.0	54.0	123.00	8	14.00
B18018.0	18.00	182.0	56.0	130.00	8	14.00
B18019.0	19.00	189.0	58.0	131.00	8	16.00
B18020.0	20.00	195.0	60.0	137.00	8	16.00



B170



HSS-E Strojní výstružník s válcovou stopkou a dělením po 0.01 mm, Leštěný

Velikosti výstružníků s dělením po 0.01 mm dovolují vytvořit přesný rozměr a toleranci otvoru. Pravotočivý výstružník s levotočivými břity a přesně broušenou geometrií umožňuje hladký řez a jakostní povrch. Vhodný pro širokou oblast obráběných materiálů.

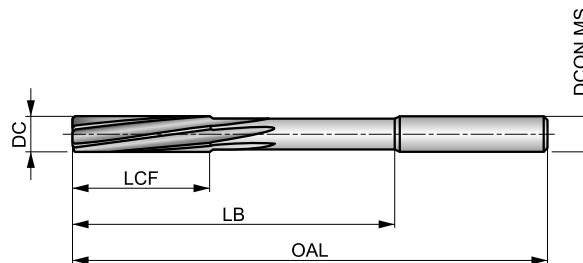

HSS-E	Bright	DIN 212
R		B
$\phi_{.95-5.5}$ $+0.004$ $\phi_{5.51-12}$ $+0.005$		

Skupiny obráběných materiálů, startovní řezná rychlost (Vc m/min) a kód posuvu. Tabulku s posuvem na otáčku naleznete od strany 251.

P1.1 ■ 21 C	P1.2 ■ 24 C	P1.3 ■ 25 C	P2.1 ■ 18 C	P2.2 ■ 16 C	P2.3 ■ 14 B	P3.1 ■ 13 B	P3.2 ■ 11 B	P3.3 ■ 9 B	P4.1 ■ 8 B	P4.2 ■ 7 B	P4.3 ■ 5 A	M1.1 ■ 11 C	M1.2 ■ 10 B
M2.1 ■ 9 B	K1.1 ■ 16 E	K1.2 ■ 12 D	K1.3 ■ 9 D	K2.1 ■ 16 C	K2.2 ■ 13 C	K2.3 ■ 10 C	K3.1 ■ 14 C	K3.2 ■ 11 C	N1.1 ■ 24 D	N1.2 ■ 18 F	N1.3 ■ 11 F	N2.1 ■ 27 E	N2.2 ■ 24 E
N2.3 ■ 16 E	N3.1 ■ 47 D	N3.2 ■ 28 E	N3.3 ■ 14 D	N4.1 ■ 30 B									

DCON MS v toleranci h9.

Produkt	DC	OAL	LCF	LB	NOF	DCON MS
	(mm)	(mm)	(mm)	(mm)		(mm)
B170.98	0.98	34.0	5.5	15.00	3	1.00
B170.99	0.99	34.0	5.5	15.00	3	1.00
B1701.0	1.00	34.0	5.5	15.00	3	1.00
B1701.01	1.01	34.0	5.5	15.00	3	1.00
B1701.02	1.02	34.0	5.5	15.00	3	1.00
B1701.03	1.03	34.0	5.5	15.00	3	1.00
B1701.04	1.04	34.0	5.5	15.00	3	1.00
B1701.05	1.05	34.0	5.5	15.00	3	1.00
B1701.49	1.49	40.0	8.0	18.00	3	1.50
B1701.5	1.50	40.0	8.0	18.00	3	1.50
B1701.51	1.51	43.0	9.0	20.00	3	1.60
B1701.52	1.52	43.0	9.0	20.00	3	1.60
B1701.98	1.98	49.0	11.0	24.00	4	2.00
B1701.99	1.99	49.0	11.0	24.00	4	2.00
B1702.0	2.00	49.0	11.0	24.00	4	2.00
B1702.01	2.01	49.0	11.0	24.00	4	2.00
B1702.02	2.02	49.0	11.0	24.00	4	2.00
B1702.03	2.03	49.0	11.0	24.00	4	2.00
B1702.04	2.04	49.0	11.0	24.00	4	2.00
B1702.05	2.05	49.0	11.0	24.00	4	2.00
B1702.49	2.49	57.0	14.0	28.00	4	2.50
B1702.5	2.50	57.0	14.0	28.00	4	2.50
B1702.51	2.51	57.0	14.0	28.00	4	2.50
B1702.52	2.52	57.0	14.0	28.00	4	2.50
B1702.98	2.98	61.0	15.0	32.00	6	3.00
B1702.99	2.99	61.0	15.0	32.00	6	3.00
B1703.0	3.00	61.0	15.0	32.00	6	3.00

Produkt	DC	OAL	LCF	LB	NOF	DCON MS
	(mm)	(mm)	(mm)	(mm)		(mm)
B1703.01	3.01	65.0	16.0	35.00	6	3.20
B1703.02	3.02	65.0	16.0	35.00	6	3.20
B1703.03	3.03	65.0	16.0	35.00	6	3.20
B1703.04	3.04	65.0	16.0	35.00	6	3.20
B1703.05	3.05	65.0	16.0	35.00	6	3.20
B1703.49	3.49	70.0	18.0	40.00	6	3.50
B1703.5	3.50	70.0	18.0	40.00	6	3.50
B1703.51	3.51	70.0	18.0	40.00	6	3.50
B1703.52	3.52	70.0	18.0	40.00	6	3.50
B1703.98	3.98	75.0	19.0	43.00	6	4.00
B1703.99	3.99	75.0	19.0	43.00	6	4.00
B1704.0	4.00	75.0	19.0	43.00	6	4.00
B1704.01	4.01	75.0	19.0	43.00	6	4.00
B1704.02	4.02	75.0	19.0	43.00	6	4.00
B1704.03	4.03	75.0	19.0	43.00	6	4.00
B1704.04	4.04	75.0	19.0	43.00	6	4.00
B1704.05	4.05	75.0	19.0	43.00	6	4.00
B1704.49	4.49	80.0	21.0	47.00	6	4.50
B1704.5	4.50	80.0	21.0	47.00	6	4.50
B1704.51	4.51	80.0	21.0	47.00	6	4.50
B1704.52	4.52	80.0	21.0	47.00	6	4.50
B1704.98	4.98	86.0	23.0	52.00	6	5.00
B1704.99	4.99	86.0	23.0	52.00	6	5.00
B1705.0	5.00	86.0	23.0	52.00	6	5.00
B1705.01	5.01	86.0	23.0	52.00	6	5.00
B1705.02	5.02	86.0	23.0	52.00	6	5.00
B1705.03	5.03	86.0	23.0	52.00	6	5.00



Produkt	DC	OAL	LCF	LB	NOF	DCON MS
	(mm)	(mm)	(mm)	(mm)		(mm)
B1705.04	5.04	86.0	23.0	52.00	6	5.00
B1705.05	5.05	86.0	23.0	52.00	6	5.00
B1705.49	5.49	93.0	26.0	57.00	6	5.60
B1705.5	5.50	93.0	26.0	57.00	6	5.60
B1705.51	5.51	93.0	26.0	57.00	6	5.60
B1705.52	5.52	93.0	26.0	57.00	6	5.60
B1705.98	5.98	93.0	26.0	57.00	6	5.60
B1705.99	5.99	93.0	26.0	57.00	6	5.60
B1706.0	6.00	93.0	26.0	57.00	6	5.60
B1706.01	6.01	101.0	28.0	63.00	6	6.30
B1706.02	6.02	101.0	28.0	63.00	6	6.30
B1706.03	6.03	101.0	28.0	63.00	6	6.30
B1706.04	6.04	101.0	28.0	63.00	6	6.30
B1706.05	6.05	101.0	28.0	63.00	6	6.30
B1706.49	6.49	101.0	28.0	63.00	6	6.30
B1706.5	6.50	101.0	28.0	63.00	6	6.30
B1706.51	6.51	101.0	28.0	63.00	6	6.30
B1706.52	6.52	101.0	28.0	63.00	6	6.30
B1706.98	6.98	109.0	31.0	69.00	6	7.10
B1706.99	6.99	109.0	31.0	69.00	6	7.10
B1707.0	7.00	109.0	31.0	69.00	6	7.10
B1707.01	7.01	109.0	31.0	69.00	6	7.10
B1707.02	7.02	109.0	31.0	69.00	6	7.10
B1707.03	7.03	109.0	31.0	69.00	6	7.10
B1707.04	7.04	109.0	31.0	69.00	6	7.10
B1707.05	7.05	109.0	31.0	69.00	6	7.10
B1707.49	7.49	109.0	31.0	69.00	6	7.10
B1707.5	7.50	109.0	31.0	69.00	6	7.10
B1707.51	7.51	117.0	33.0	75.00	6	8.00
B1707.52	7.52	117.0	33.0	75.00	6	8.00
B1707.98	7.98	117.0	33.0	75.00	6	8.00
B1707.99	7.99	117.0	33.0	75.00	6	8.00
B1708.0	8.00	117.0	33.0	75.00	6	8.00
B1708.01	8.01	117.0	33.0	75.00	6	8.00
B1708.02	8.02	117.0	33.0	75.00	6	8.00
B1708.03	8.03	117.0	33.0	75.00	6	8.00
B1708.04	8.04	117.0	33.0	75.00	6	8.00
B1708.05	8.05	117.0	33.0	75.00	6	8.00
B1708.49	8.49	117.0	33.0	75.00	6	8.00
B1708.5	8.50	117.0	33.0	75.00	6	8.00

Produkt	DC	OAL	LCF	LB	NOF	DCON MS
	(mm)	(mm)	(mm)	(mm)		(mm)
B1708.51	8.51	125.0	36.0	81.00	6	9.00
B1708.52	8.52	125.0	36.0	81.00	6	9.00
B1708.98	8.98	125.0	36.0	81.00	6	9.00
B1708.99	8.99	125.0	36.0	81.00	6	9.00
B1709.0	9.00	125.0	36.0	81.00	6	9.00
B1709.01	9.01	125.0	36.0	81.00	6	9.00
B1709.02	9.02	125.0	36.0	81.00	6	9.00
B1709.03	9.03	125.0	36.0	81.00	6	9.00
B1709.04	9.04	125.0	36.0	81.00	6	9.00
B1709.05	9.05	125.0	36.0	81.00	6	9.00
B1709.49	9.49	125.0	36.0	81.00	6	9.00
B1709.5	9.50	125.0	36.0	81.00	6	9.00
B1709.51	9.51	133.0	38.0	87.00	6	10.00
B1709.52	9.52	133.0	38.0	87.00	6	10.00
B1709.98	9.98	133.0	38.0	87.00	6	10.00
B1709.99	9.99	133.0	38.0	87.00	6	10.00
B17010.0	10.00	133.0	38.0	87.00	6	10.00
B17010.01	10.01	133.0	38.0	87.00	6	10.00
B17010.02	10.02	133.0	38.0	87.00	6	10.00
B17010.03	10.03	133.0	38.0	87.00	6	10.00
B17010.04	10.04	133.0	38.0	87.00	6	10.00
B17010.05	10.05	133.0	38.0	87.00	6	10.00
B17010.49	10.49	133.0	38.0	87.00	6	10.00
B17010.51	10.51	133.0	38.0	87.00	6	10.00
B17010.52	10.52	133.0	38.0	87.00	6	10.00
B17010.98	10.98	142.0	41.0	96.00	6	10.00
B17010.99	10.99	142.0	41.0	96.00	6	10.00
B17011.0	11.00	142.0	41.0	96.00	6	10.00
B17011.01	11.01	142.0	41.0	96.00	6	10.00
B17011.02	11.02	142.0	41.0	96.00	6	10.00
B17011.03	11.03	142.0	41.0	96.00	6	10.00
B17011.04	11.04	142.0	41.0	96.00	6	10.00
B17011.05	11.05	142.0	41.0	96.00	6	10.00
B17011.49	11.49	142.0	41.0	96.00	6	10.00
B17011.5	11.50	142.0	41.0	96.00	6	10.00
B17011.51	11.51	142.0	41.0	96.00	6	10.00
B17011.52	11.52	142.0	41.0	96.00	6	10.00
B17011.98	11.98	151.0	44.0	105.00	6	10.00
B17011.99	11.99	151.0	44.0	105.00	6	10.00
B17012.0	12.00	151.0	44.0	105.00	6	10.00



B157



HSS-E Strojní výstružník s válcovou stopkou, malým úhlem šroubovice, Tolerance H7, Leštěný

Strojní pravotočivý výstružník s levotočivou spirálou pro zlepšení produktivity při obrábění neželezných kovů, především hliníku ale i dalších materiálů. Kuželový náběh usnadňuje vystředění a zlepšuje kvalitu otvoru.

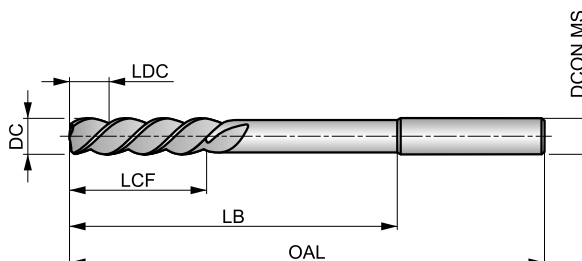

HSS-E	Bright	DIN 212
R		E
H7		

Skupiny obráběných materiálů, startovní řezná rychlost (Vc m/min) a kód posuvu. Tabulku s posuvem na otáčku naleznete od strany 251.

P1.1 ■ 21 C	P1.2 ■ 24 C	P1.3 ■ 25 C	P2.1 ■ 18 C	P2.2 ■ 16 C	P3.1 ■ 13 B	P3.2 ■ 11 B	M1.1 ■ 11 C	M1.2 ■ 10 C	M2.1 ■ 9 C	M2.2 ■ 8 B	M2.3 ■ 7 B	N1.1 ■ 28 F	N1.2 ■ 21 F
N1.3 ■ 14 F	N2.1 ■ 31 E	N2.2 ■ 28 E	N2.3 ■ 20 E										

DCON MS v toleranci h9.

Produkt	DC (mm)	OAL (mm)	LCF (mm)	LDC (mm)	LB (mm)	NOF	DCON MS (mm)
B1572.0	2.00	49.0	11.0	3.50	24.00	3	2.00
B1573.0	3.00	61.0	15.0	4.00	32.00	3	3.00
B1574.0	4.00	75.0	19.0	4.00	43.00	3	4.00
B1575.0	5.00	86.0	23.0	4.50	52.00	3	5.00
B1576.0	6.00	93.0	26.0	6.00	57.00	3	5.60
B1577.0	7.00	109.0	31.0	7.00	69.00	3	7.10
B1578.0	8.00	117.0	33.0	9.00	75.00	3	8.00
B1579.0	9.00	125.0	36.0	9.50	81.00	3	9.00
B15710.0	10.00	133.0	38.0	10.00	87.00	3	10.00
B15711.0	11.00	142.0	41.0	10.50	96.00	3	10.00
B15712.0	12.00	151.0	44.0	11.00	105.00	3	10.00
B15713.0	13.00	151.0	44.0	11.50	105.00	3	10.00
B15714.0	14.00	160.0	47.0	12.00	110.00	3	12.50
B15715.0	15.00	162.0	50.0	12.50	112.00	3	12.50
B15716.0	16.00	170.0	52.0	13.00	120.00	3	12.50
B15717.0	17.00	175.0	54.0	13.50	123.00	3	14.00
B15718.0	18.00	182.0	56.0	14.00	130.00	3	14.00
B15719.0	19.00	189.0	58.0	14.50	131.00	3	16.00
B15720.0	20.00	195.0	60.0	15.00	137.00	3	16.00



B161



HSS-E Strojní výstružník s kuželovou stopkou, Tolerance H7, Leštěný

Přesně broušený pravotočivý výstružník s levotočivou spirálou pro hladký řez a zlepšení rozměrové přesnosti i jakosti povrchu. Vhodný pro širokou oblast obráběných materiálů.

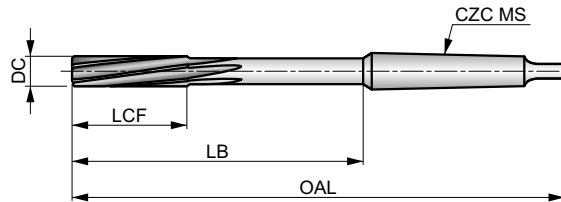

HSS-E	Bright	DIN 208
R		B
H7		

Skupiny obráběných materiálů, startovní řezná rychlost (Vc m/min) a kód posuvu. Tabulku s posuvem na otáčku naleznete od strany 251.

P1.1 ■ 21 C	P1.2 ■ 24 C	P1.3 ■ 25 C	P2.1 ■ 18 C	P2.2 ■ 16 C	P2.3 ▣ 14 B	P3.1 ■ 13 B	P3.2 ■ 11 B	P3.3 ▣ 9 B	P4.1 ■ 8 B	P4.2 ▣ 7 B	P4.3 ▣ 5 A	M1.1 ▣ 11 C	M1.2 ▣ 10 B
M2.1 ▣ 9 B	K1.1 ■ 16 E	K1.2 ■ 12 D	K1.3 ▣ 9 D	K2.1 ■ 16 C	K2.2 ■ 13 C	K2.3 ▣ 10 C	K3.1 ■ 14 C	K3.2 ▣ 11 C	N1.1 ▣ 24 F	N1.2 ■ 18 F	N1.3 ■ 11 F	N2.1 ▣ 27 E	N2.2 ■ 24 E
N2.3 ■ 16 E	N3.1 ■ 47 D	N3.2 ■ 28 E	N3.3 ▣ 14 D	N4.1 ▣ 30 B									

Produkt	DC (mm)	OAL (mm)	LCF (mm)	LB (mm)	NOF	CZC MS
B1613.0	3.00	113.0	15.0	47.50	6	MK 1
B1614.0	4.00	124.0	19.0	58.50	6	MK 1
B1615.0	5.00	133.0	23.0	67.50	6	MK 1
B1616.0	6.00	138.0	26.0	72.50	6	MK 1
B1617.0	7.00	150.0	31.0	84.50	6	MK 1
B1618.0	8.00	156.0	33.0	90.50	6	MK 1
B1619.0	9.00	162.0	36.0	96.50	6	MK 1
B16110.0	10.00	168.0	38.0	102.50	6	MK 1
B16111.0	11.00	175.0	41.0	109.50	6	MK 1
B16112.0	12.00	182.0	44.0	116.50	6	MK 1
B16113.0	13.00	182.0	44.0	116.50	6	MK 1
B16114.0	14.00	189.0	47.0	123.50	8	MK 1
B16115.0	15.00	204.0	50.0	124.00	8	MK 2
B16116.0	16.00	210.0	52.0	130.00	8	MK 2
B16117.0	17.00	214.0	54.0	134.00	8	MK 2
B16118.0	18.00	219.0	56.0	139.00	8	MK 2
B16119.0	19.00	223.0	58.0	143.00	8	MK 2
B16120.0	20.00	228.0	60.0	148.00	8	MK 2
B16121.0	21.00	232.0	62.0	152.00	8	MK 2
B16122.0	22.00	237.0	64.0	157.00	8	MK 2
B16123.0	23.00	241.0	66.0	161.00	8	MK 2
B16124.0	24.00	268.0	68.0	169.00	8	MK 3

Produkt	DC (mm)	OAL (mm)	LCF (mm)	LB (mm)	NOF	CZC MS
B16125.0	25.00	268.0	68.0	169.00	8	MK 3
B16126.0	26.00	273.0	70.0	174.00	8	MK 3
B16127.0	27.00	277.0	71.0	178.00	10	MK 3
B16128.0	28.00	277.0	71.0	178.00	10	MK 3
B16129.0	29.00	281.0	73.0	182.00	10	MK 3
B16130.0	30.00	281.0	73.0	182.00	10	MK 3
B16131.0	31.00	285.0	75.0	186.00	10	MK 3
B16132.0	32.00	317.0	77.0	193.00	10	MK 4
B16133.0	33.00	317.0	77.0	193.00	10	MK 4
B16134.0	34.00	321.0	78.0	197.00	10	MK 4
B16135.0	35.00	321.0	78.0	197.00	10	MK 4
B16136.0	36.00	325.0	79.0	201.00	10	MK 4
B16138.0	38.00	329.0	81.0	205.00	10	MK 4
B16140.0	40.00	329.0	81.0	205.00	10	MK 4
B16142.0	42.00	333.0	82.0	209.00	12	MK 4
B16144.0	44.00	336.0	83.0	212.00	12	MK 4
B16145.0	45.00	336.0	83.0	212.00	12	MK 4
B16146.0	46.00	340.0	84.0	216.00	12	MK 4
B16147.0	47.00	340.0	84.0	216.00	12	MK 4
B16148.0	48.00	344.0	86.0	220.00	12	MK 4
B16150.0	50.00	344.0	86.0	220.00	12	MK 4



B101



HSS-E Strojní výstružník s kuželovou stopkou, Tolerancí H7

Strojní výstružník s kuželovou stopkou dle BS 328. Přesně broušený pravotočivý výstružník s levotočivou šroubovicí pro zlepšení rozměrové přesnosti i jakosti povrchu. Vhodný pro širokou oblast obráběných materiálů.

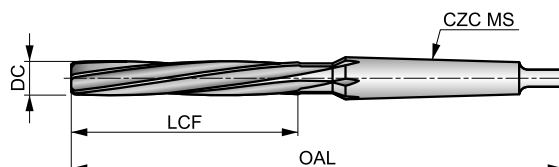

HSS-E	Bright ST	BS 328
R		B
H7		

Skupiny obráběných materiálů, startovní řezná rychlost (Vc m/min) a kód posuvu. Tabulku s posuvem na otáčku naleznete od strany 251.

P1.1 ■ 15 C	P1.2 ■ 16 C	P1.3 ■ 17 C	P2.1 ■ 13 C	P2.2 ■ 11 C	P2.3 ▣ 10 B	P3.1 ■ 7 B	P3.2 ■ 6 B	P3.3 ▣ 5 B	P4.1 ■ 4 B	P4.2 ▣ 4 B	P4.3 ▣ 3 A	M1.1 ▣ 7 B	M1.2 ▣ 6 A
K1.1 ■ 14 E	K1.2 ■ 10 D	K1.3 ▣ 8 D	K2.1 ■ 12 C	K2.2 ■ 10 C	K2.3 ▣ 8 C	K3.1 ■ 11 C	K3.2 ▣ 8 C	N1.1 ▣ 23 F	N1.2 ■ 17 F	N1.3 ■ 9 F	N2.1 ▣ 25 E	N2.2 ■ 18 E	N2.3 ■ 14 E
N3.1 ■ 34 D	N3.2 ■ 20 E	N3.3 ▣ 10 D	N4.1 ▣ 22 B										

Produkt	DC	DC	OAL	LCF	NOF	CZC MS
	(inch)	(mm)	(mm)	(mm)		
B1013.0	–	3.00	112.0	33.0	4	MK 1
B1011/8	1/8	3.18	112.0	33.0	4	MK 1
B1013.5	–	3.50	115.0	35.0	6	MK 1
B1014.0	–	4.00	117.0	38.0	6	MK 1
B1014.5	–	4.50	120.0	41.0	6	MK 1
B1013/16	3/16	4.76	124.0	44.0	6	MK 1
B1015.0	–	5.00	124.0	44.0	6	MK 1
B1015.5	–	5.50	127.0	47.0	6	MK 1
B1016.0	–	6.00	127.0	47.0	6	MK 1
B1011/4	1/4	6.35	130.0	50.0	6	MK 1
B1016.5	–	6.50	130.0	50.0	6	MK 1
B1017.0	–	7.00	134.0	54.0	6	MK 1
B1015/16	5/16	7.94	138.0	58.0	6	MK 1
B1018.0	–	8.00	138.0	58.0	6	MK 1
B1018.5	–	8.50	138.0	58.0	6	MK 1
B1019.0	–	9.00	142.0	62.0	6	MK 1
B1019.5	–	9.50	142.0	62.0	6	MK 1
B1013/8	3/8	9.52	146.0	66.0	6	MK 1
B10110.0	–	10.00	146.0	66.0	6	MK 1
B10110.5	–	10.50	146.0	66.0	6	MK 1
B10111.0	–	11.00	151.0	71.0	6	MK 1
B1017/16	7/16	11.11	151.0	71.0	6	MK 1
B10112.0	–	12.00	156.0	76.0	6	MK 1
B10112.5	–	12.50	156.0	76.0	6	MK 1
B1011/2	1/2	12.70	156.0	76.0	6	MK 1
B10113.0	–	13.00	156.0	76.0	6	MK 1
B10113.5	–	13.50	161.0	81.0	6	MK 1
B10114.0	–	14.00	161.0	81.0	8	MK 1

Produkt	DC	DC	OAL	LCF	NOF	CZC MS
	(inch)	(mm)	(mm)	(mm)		
B1019/16	9/16	14.29	181.0	81.0	8	MK 2
B10114.5	–	14.50	181.0	81.0	8	MK 2
B10115.0	–	15.00	181.0	81.0	8	MK 2
B10115.5	–	15.50	187.0	87.0	8	MK 2
B1015/8	5/8	15.88	187.0	87.0	8	MK 2
B10116.0	–	16.00	187.0	87.0	8	MK 2
B10116.5	–	16.50	187.0	87.0	8	MK 2
B10117.0	–	17.00	187.0	87.0	8	MK 2
B10118.0	–	18.00	193.0	93.0	8	MK 2
B10119.0	–	19.00	193.0	93.0	8	MK 2
B1013/4	3/4	19.05	200.0	100.0	8	MK 2
B10120.0	–	20.00	200.0	100.0	8	MK 2
B10113/16	13/16	20.64	200.0	100.0	8	MK 2
B10121.0	–	21.00	200.0	100.0	8	MK 2
B10122.0	–	22.00	207.0	107.0	8	MK 2
B1017/8	7/8	22.22	207.0	107.0	8	MK 2
B10123.0	–	23.00	207.0	107.0	8	MK 2
B10124.0	–	24.00	242.0	115.0	8	MK 3
B10125.0	–	25.00	242.0	115.0	10	MK 3
B1011	1"	25.40	242.0	115.0	10	MK 3
B10126.0	–	26.00	242.0	115.0	10	MK 3
B10127.0	–	27.00	251.0	124.0	10	MK 3
B10128.0	–	28.00	251.0	124.0	10	MK 3
B1011.1/8	1.1/8	28.58	251.0	124.0	10	MK 3
B10129.0	–	29.00	251.0	124.0	10	MK 3
B10130.0	–	30.00	251.0	124.0	10	MK 3
B10131.0	–	31.00	260.0	133.0	10	MK 3
B1011.1/4	1.1/4	31.75	260.0	133.0	10	MK 3



Produkt	DC	DC	OAL	LCF	NOF	CZC MS
	(inch)	(mm)	(mm)	(mm)		
B10132.0	–	32.00	293.0	133.0	10	MK 4
B10134.0	–	34.00	302.0	142.0	10	MK 4
B1011.3/8	1.3/8	34.93	302.0	142.0	10	MK 4
B10135.0	–	35.00	302.0	142.0	10	MK 4
B10136.0	–	36.00	302.0	142.0	10	MK 4
B10137.0	–	37.00	302.0	142.0	10	MK 4
B10138.0	–	38.00	312.0	152.0	10	MK 4
B1011.1/2	1.1/2	38.10	312.0	152.0	10	MK 4
B10139.0	–	39.00	312.0	152.0	10	MK 4
B10140.0	–	40.00	312.0	152.0	10	MK 4
B10141.0	–	41.00	312.0	152.0	10	MK 4

Produkt	DC	DC	OAL	LCF	NOF	CZC MS
	(inch)	(mm)	(mm)	(mm)		
B10142.0	–	42.00	312.0	152.0	10	MK 4
B10143.0	–	43.00	323.0	163.0	10	MK 4
B10144.0	–	44.00	323.0	163.0	10	MK 4
B1011.3/4	1.3/4	44.45	323.0	163.0	10	MK 4
B10145.0	–	45.00	323.0	163.0	12	MK 4
B10146.0	–	46.00	323.0	163.0	12	MK 4
B10147.0	–	47.00	323.0	163.0	12	MK 4
B10148.0	–	48.00	334.0	174.0	12	MK 4
B10150.0	–	50.00	334.0	174.0	12	MK 4
B1012	2"	50.80	334.0	174.0	12	MK 4



B121



HSS Strojní výstružník s kuželovou stopkou a kuželovým náběhem

Konstruován pro sestružení otvorů u sériově vyráběných dílů, kde jsou spojovány dva nebo více dílů před sešroubováním či snýtváním. Malý náběh s kuzelem 1:10 usnadňuje sestružení předvrtaných otvorů. Vhodný pro širokou oblast obráběných materiálů.

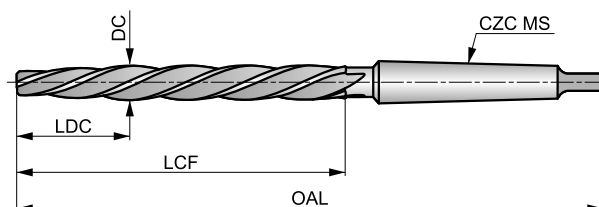

HSS	Bright ST	DIN 311
R		k11

Skupiny obráběných materiálů, startovní řezná rychlost (Vc m/min) a kód posuvu. Tabulku s posuvem na otáčku naleznete od strany 251.

P1.1 ■ 15 C	P1.2 ■ 16 C	P1.3 ■ 17 C	P2.1 ■ 13 C	P2.2 ■ 11 C	P2.3 ▣ 10 B	P3.1 ■ 7 B	P3.2 ■ 6 B	P3.3 ▣ 5 B	P4.1 ■ 4 B	P4.2 ▣ 4 B	P4.3 ▣ 3 A	K1.1 ■ 14 E	K1.2 ■ 10 D
K1.3 ▣ 8 D	K2.1 ■ 12 C	K2.2 ■ 10 C	K2.3 ▣ 8 C	K3.1 ▣ 11 C	K3.2 ▣ 8 C	N1.1 ▣ 23 F	N1.2 ■ 17 F	N1.3 ■ 9 F	N2.1 ▣ 21 E	N2.2 ■ 18 E	N2.3 ▣ 14 E	N3.1 ■ 34 D	N3.2 ■ 20 E
N3.3 ▣ 10 D	N4.1 ▣ 21 B												

S náběhovým kuzelem 1:10 (LCD).

Produkt	DC (mm)	OAL (mm)	LCF (mm)	LDC (mm)	NOF	CZC MS
B12110.0	10.00	171.0	95.0	30.00	4	MK 1
B12111.0	11.00	176.0	100.0	33.00	4	MK 1
B12112.0	12.00	199.0	105.0	39.00	4	MK 2
B12113.0	13.00	199.0	105.0	39.00	4	MK 2
B12114.0	14.00	209.0	115.0	42.00	4	MK 2
B12115.0	15.00	219.0	125.0	45.00	4	MK 2
B12116.0	16.00	229.0	135.0	48.00	4	MK 2
B12117.0	17.00	251.0	135.0	51.00	4	MK 3
B12118.0	18.00	261.0	145.0	58.00	4	MK 3
B12119.0	19.00	261.0	145.0	58.00	4	MK 3
B12120.0	20.00	271.0	155.0	62.00	4	MK 3
B12121.0	21.00	271.0	155.0	62.00	4	MK 3
B12122.0	22.00	281.0	165.0	66.00	4	MK 3
B12123.0	23.00	281.0	165.0	66.00	4	MK 3
B12124.0	24.00	296.0	180.0	72.00	4	MK 3
B12125.0	25.00	296.0	180.0	72.00	4	MK 3
B12126.0	26.00	296.0	180.0	72.00	4	MK 3
B12130.0	30.00	311.0	195.0	78.00	5	MK 3



B954



HSS-E Strojní výstružník na kuželové kolíky s kuzelem 1:50

Výstružník se zvýšenou přesností a produktivitou dosaženou speciální geometrií - pravotočivý výstružník s levotočivými břity. Konstruovaný pro dokončování kuželových otvorů s kuzelem 1:50 (metrické míry kuželových kolíků). Vhodný pro vystružování mnoha materiálů.

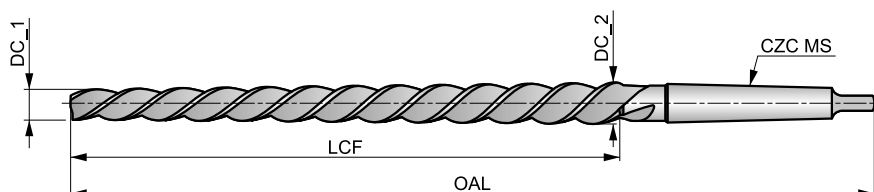

HSS-E	Bright	DIN 2180
R		1:50

Skupiny obráběných materiálů, startovní řezná rychlost (Vc m/min) a kód posuvu. Tabulku s posuvem na otáčku naleznete od strany 251.

P1.1 ■ 10 B	P1.2 ■ 12 B	P1.3 ■ 13 B	P2.1 ■ 9 B	P2.2 ■ 8 B	P2.3 ▣ 6 A	P3.1 ■ 7 A	P3.2 ■ 6 A	P3.3 ▣ 3 A	P4.1 ■ 4 A	P4.2 ▣ 3 A	P4.3 ▣ 2 A	M1.1 ▣ 11 C	M1.2 ▣ 10 B
M2.1 ▣ 9 B	M2.2 ▣ 8 B	K1.1 ■ 10 C	K1.2 ■ 6 B	K1.3 ▣ 4 B	K2.1 ■ 8 A	K2.2 ■ 6 A	K2.3 ▣ 4 A	K3.1 ■ 11 A	K3.2 ▣ 8 A	N1.1 ▣ 14 F	N1.2 ■ 12 F	N1.3 ■ 9 F	N2.1 ■ 16 E
N2.2 ■ 14 E	N2.3 ▣ 10 E	N3.1 ■ 22	N3.2 ■ 14 E	N3.3 ▣ 6	N4.1 ▣ 22 B								

Produkt	nom d	DC_1	DC_2	OAL	LCF	NOF	CZC MS
		(mm)	(mm)	(mm)	(mm)		
B9545.0	5.0	4.90	6.36	155.0	73.0	3	MK 1
B9546.0	6.0	5.90	8.00	187.0	105.0	3	MK 1
B9548.0	8.0	7.90	10.80	227.0	145.0	3	MK 1
B95410.0	10.0	9.90	13.40	257.0	175.0	3	MK 1
B95412.0	12.0	11.80	16.00	315.0	210.0	3	MK 2
B95413.0	13.0	12.86	16.74	295.0	194.0	3	MK 2
B95414.0	14.0	13.86	17.74	295.0	194.0	3	MK 2
B95416.0	16.0	15.80	20.40	335.0	230.0	3	MK 2
B95420.0	20.0	19.80	24.80	377.0	250.0	3	MK 3
B95425.0	25.0	24.70	30.70	427.0	300.0	3	MK 3
B95430.0	30.0	29.70	36.10	475.0	320.0	4	MK 4



B955



HSS-E Nástrčný výstružník v toleranci H7, Leštěný, Parní temperace povrchu

Nástrčný výstružník upínaný do vhodného upínacího trnu. Pravotočivý výstružník s levotočivými břity a přesně broušenou geometrií umožňuje hladký řez. Náběh 45° pro snadné vystředění a přesný rozměr otvoru a jakostní povrch. Vhodný pro širokou oblast obráběných materiálů včetně ocelí.

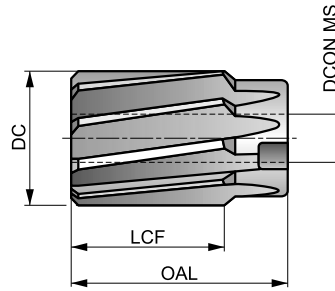

HSS-E	Bright ST	DIN 219
R	B	H7

Skupiny obráběných materiálů, startovní řezná rychlost (Vc m/min) a kód posuvu. Tabulku s posuvem na otáčku naleznete od strany 251.

P1.1 ■ 15 C	P1.2 ■ 16 C	P1.3 ■ 17 C	P2.1 ■ 13 C	P2.2 ■ 11 C	P2.3 ▧ 10 B	P3.1 ■ 7 B	P3.2 ■ 6 B	P3.3 ▧ 5 B	P4.1 ■ 4 B	P4.2 ▧ 4 B	P4.3 ▧ 3 A	M1.1 ▧ 11 C	M1.2 ▧ 10 B
M2.1 ▧ 9 B	K1.1 ■ 10 E	K1.2 ■ 8 D	K1.3 ▧ 7 D	K2.1 ■ 10 C	K2.2 ■ 9 C	K2.3 ▧ 6 C	K3.1 ▧ 10 C	K3.2 ▧ 7 C	N1.1 ▧ 17 F	N1.2 ■ 17 F	N1.3 ■ 10 F	N2.1 ▧ 23 E	N2.2 ■ 21 E
N2.3 ■ 13 E	N3.1 ■ 34 D	N3.2 ■ 20 E	N3.3 ▧ 10 D	N4.1 ▧ 24 C									

Produkt	DC (mm)	OAL (mm)	LCF (mm)	NOF	DCON MS (mm)
B95525.0	25.00	45.0	32.0	8	13.00
B95526.0	26.00	45.0	32.0	8	13.00
B95527.0	27.00	45.0	32.0	8	13.00
B95528.0	28.00	45.0	32.0	8	13.00
B95529.0	29.00	45.0	32.0	8	13.00
B95530.0	30.00	45.0	32.0	8	13.00
B95531.0	31.00	50.0	36.0	10	16.00
B95532.0	32.00	50.0	36.0	10	16.00
B95534.0	34.00	50.0	36.0	10	16.00
B95535.0	35.00	50.0	36.0	10	16.00
B95536.0	36.00	56.0	40.0	10	19.00
B95537.0	37.00	56.0	40.0	10	19.00
B95538.0	38.00	56.0	40.0	10	19.00
B95540.0	40.00	56.0	40.0	10	19.00

Produkt	DC (mm)	OAL (mm)	LCF (mm)	NOF	DCON MS (mm)
B95542.0	42.00	56.0	40.0	10	19.00
B95544.0	44.00	63.0	45.0	12	22.00
B95545.0	45.00	63.0	45.0	12	22.00
B95548.0	48.00	63.0	45.0	12	22.00
B95550.0	50.00	63.0	45.0	12	22.00
B95552.0	52.00	71.0	50.0	12	27.00
B95555.0	55.00	71.0	50.0	12	27.00
B95558.0	58.00	71.0	50.0	12	27.00
B95560.0	60.00	71.0	50.0	12	27.00
B95565.0	65.00	80.0	56.0	14	32.00
B95570.0	70.00	80.0	56.0	14	32.00
B95575.0	75.00	90.0	63.0	14	40.00
B95580.0	80.00	90.0	63.0	14	40.00



B956



Upínací trn pro výstružník B955

Upínací trn pro nástrčné výstružníky. Konstruován s kuželovou stopkou pro upnutí přímo do vřetene stroje. Náhradní díly k upínači (klíče, matice, podložky) naleznete v katalogu pod označením B957.

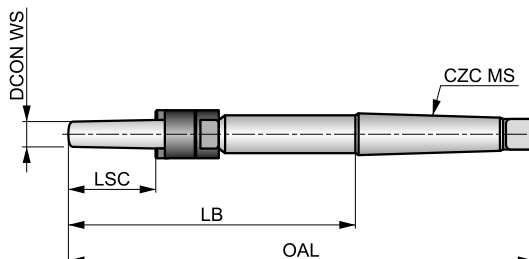

HSS-E	Bright	DIN 217

Produkt	DCON WS (mm)	OAL (mm)	LSC (mm)	LB (mm)	CZC MS
B95613.0	13.00	250.0	45	151.00	MK 3
B95616.0	16.00	261.0	50	162.00	MK 3
B95619.0	19.00	298.0	56	174.00	MK 4
B95622.0	22.00	312.0	63	188.00	MK 4
B95627.0	27.00	359.0	71	203.00	MK 5
B95632.0	32.00	376.0	80	220.00	MK 5
B95640.0	40.00	396.0	90	240.00	MK 5



B957

DORMER



Náhradní díly pro upínací trn B956

Náhradní díly B957 pro upínací trn B956 obsahují klíč, matici a podložku. Mohou být objednávány jednotlivě po velikostech. Všechny náhradní díly jsou vyráběny dle požadovaných norem.

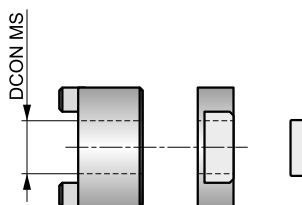

Produkt	Nr.	DCON MS
		(mm)
B957N3DRIVER	3	13.00
B957N3NUT	3	–
B957N3WASHER	3	–
B957N4DRIVER	4	16.00
B957N4NUT	4	–
B957N4WASHER	4	–
B957N5DRIVER	5	19.00
B957N5NUT	5	–
B957N5WASHER	5	–
B957N6DRIVER	6	22.00
B957N6NUT	6	–
B957N6WASHER	6	–
B957N7DRIVER	7	27.00
B957N7NUT	7	–
B957N7WASHER	7	–
B957N8DRIVER	8	32.00
B957N8NUT	8	–
B957N8WASHER	8	–
B957N9DRIVER	9	40.00
B957N9NUT	9	–
B957N9WASHER	9	–



G400

DORMER



Karbidový záhlubník 90° s válcovou stopkou, Leštěný

Výkonný záhlubník 90° leštěný, konstruovaný pro použití na CNC strojích, kde je požadována vysoká produktivita a kvalita. Může být použitý pro záhlubování v abrazivních a tvrdých materiálech. Záhlubník je konstruován na srážení hran otvorů pro standardní šrouby s 90° hlavou.

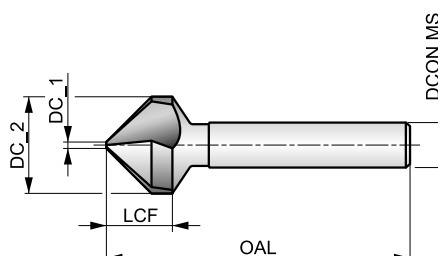

HM	Bright	DIN 335C
R	90°	

Skupiny obráběných materiálů, startovní řezná rychlost (Vc m/min) a kód posuvu. Tabulku s posuvem na otáčku naleznete od strany 251.

P1.1 ■ 64 E	P1.2 ■ 72 E	P1.3 ■ 74 E	P2.1 ■ 55 E	P2.2 ■ 48 D	P2.3 ■ 43 B	P3.1 ■ 45 D	P3.2 ■ 36 D	P3.3 ■ 30 B	P4.1 ■ 26 D	P4.2 ■ 23 B	P4.3 ■ 18 A	M1.1 ■ 24 C	M1.2 ■ 21 C
M2.1 ■ 22 C	M2.2 ▣ 18 C	M2.3 ▣ 15 B	M3.1 ■ 20 B	M3.2 ▣ 17 B	M3.3 ▣ 15 B	M4.1 ▣ 15 A	M4.2 ▣ 13 A	K1.1 ■ 45 F	K1.2 ■ 33 D	K1.3 ■ 25 D	K2.1 ■ 46 C	K2.2 ■ 37 C	K2.3 ▣ 30 C
K3.1 ■ 41 C	K3.2 ■ 31 C	K3.3 ▣ 25 C	K4.1 ■ 38 C	K4.2 ■ 28 C	K4.3 ■ 21 C	K4.4 ▣ 18 C	K4.5 ▣ 15 C	K5.1 ■ 43 C	K5.2 ■ 32 C	K5.3 ■ 25 C	N1.1 ▣ 75 G	N1.2 ■ 55 G	N1.3 ■ 40 F
N2.1 ■ 40 F	N2.2 ■ 36 F	N2.3 ■ 26 F	N3.1 ■ 42 F	N3.2 ■ 25 F	N3.3 ▣ 13 D	N4.3 ■ 17 E	S1.1 ■ 12 C	S1.2 ■ 10 A	S1.3 ▣ 9 A	S2.1 ■ 8 B	S2.2 ▣ 7 A	S3.1 ■ 6 B	S3.2 ▣ 5 A
S4.1 ■ 5 B	S4.2 ▣ 4 A	H1.1 ■ 12 A	H2.1 ■ 7 A	H2.2 ▣ 6 B	H3.1 ■ 8 A	H3.2 ▣ 7 B	H4.1 ■ 5 A	H4.2 ▣ 4 B					

DCON MS v toleranci h6.

Produkt	DC_2 (mm)	DC_1 (mm)	LCF (mm)	OAL (mm)	DCON MS (mm)	NOF
G4006.3	6.30	1.50	5.0	45.0	5.00	3
G4008.3	8.30	2.00	6.0	50.0	6.00	3
G40010.4	10.40	2.50	7.1	50.0	6.00	3
G40012.4	12.40	2.80	8.0	56.0	8.00	3
G40016.5	16.50	3.20	10.0	60.0	10.00	3
G40020.5	20.50	3.50	12.5	63.0	10.00	3
G40025.0	25.00	3.80	15.0	67.0	10.00	3
G40031.0	31.00	4.20	18.0	71.0	12.00	3



G135



HSS Záhlubník 60° s válcovou stopkou, Leštěný

Záhlubník 60° pro zahlubování otvorů pro speciální šrouby a srážení hran v otvorech do průměru 25.0 mm. Může být použit jako strojní i pro ruční nářadí. Vhodný pro širokou oblast obráběných materiálů.

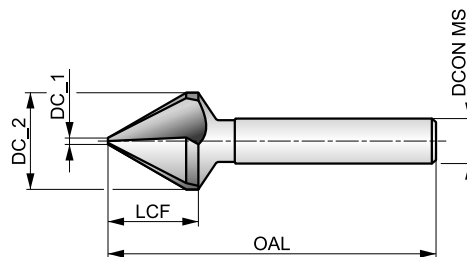

HSS	Bright	DIN 334C
R	60°	

Skupiny obráběných materiálů, startovní řezná rychlost (Vc m/min) a kód posuvu. Tabulku s posuvem na otáčku naleznete od strany 251.

P1.1 ■ 23 E	P1.2 ■ 26 E	P1.3 ■ 27 E	P2.1 ■ 20 E	P2.2 ■ 18 D	P2.3 ▣ 16 B	P3.1 ■ 16 D	P3.2 ▣ 13 D	P3.3 ▣ 11 B	P4.1 ■ 10 D	P4.2 ▣ 8 B	M1.1 ▣ 8 C	M1.2 ▣ 6 C	M2.1 ▣ 7 C
M2.2 ▣ 6 C	K1.1 ▣ 20 F	K1.2 ▣ 15 D	K2.1 ▣ 21 C	K2.2 ▣ 17 C	K3.1 ▣ 18 C	K3.2 ▣ 14 C	K5.1 ▣ 19 C	K5.2 ▣ 15 C	N1.1 ▣ 40 G	N1.2 ■ 30 G	N1.3 ▣ 20 F	N2.1 ■ 20 F	N2.2 ▣ 18 F
N3.1 ■ 21 F	N3.2 ■ 12 F	N3.3 ▣ 6 D	N4.1 ▣ 40 G	N4.2 ▣ 35 G									

DCON MS v toleranci h9.

Produkt	DC_2 (mm)	DC_1 (mm)	LCF (mm)	OAL (mm)	DCON MS (mm)	NOF
G1356.3	6.30	1.60	6.8	45.0	5.00	3
G1358.0	8.00	2.00	8.5	50.0	6.00	3
G13510.0	10.00	2.50	7.6	50.0	6.00	3
G13512.5	12.50	3.20	11.7	56.0	8.00	3
G13516.0	16.00	4.00	14.5	63.0	10.00	3
G13520.0	20.00	5.00	17.5	67.0	10.00	3
G13525.0	25.00	6.30	20.5	71.0	10.00	3



G335



HSS-E Záhlučník 60° s válcovou stopkou, Povlakovaný TiN

Záhlučník 60° pro zahlubování speciálních otvorů a srážení hran. Povlakovaný TiN pro zvýšení výkonu a prodloužení životnosti. Může být použit jako strojní i pro upínání do ručního nářadí. Vhodný pro širokou oblast obráběných materiálů.

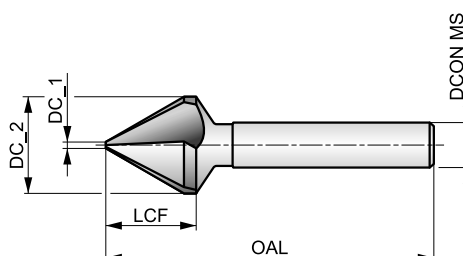

HSS	TiN	DIN 334C
R	60°	

Skupiny obráběných materiálů, startovní řezná rychlost (Vc m/min) a kód posuvu. Tabulku s posuvem na otáčku naleznete od strany 251.

P1.1 ■ 33 E	P1.2 ■ 37 E	P1.3 ■ 38 E	P2.1 ■ 28 E	P2.2 ■ 25 D	P2.3 ■ 22 B	P3.1 ■ 23 D	P3.2 ■ 18 D	P3.3 ■ 15 B	P4.1 ■ 13 D	P4.2 ■ 11 B	P4.3 ■ 9 B	M1.1 ■ 10 C	M1.2 ■ 8 C
M2.1 ■ 19 C	M3.1 ■ 8 B	K1.1 ■ 34 F	K1.2 ■ 25 D	K1.3 ■ 19 D	K2.1 ■ 35 C	K2.2 ■ 28 C	K2.3 ■ 23 C	K3.1 ■ 31 C	K3.2 ■ 24 C	K3.3 ■ 19 C	K4.1 ■ 29 C	K4.2 ■ 22 C	K4.3 ■ 16 C
K5.1 ■ 32 C	K5.2 ■ 24 C	K5.3 ■ 19 C	N1.1 ■ 53 G	N1.2 ■ 40 G	N1.3 ■ 27 F	N2.1 ■ 27 F	N2.2 ■ 24 F	N2.3 ■ 17 F	N3.1 ■ 28 F	N3.2 ■ 16 F	N3.3 ■ 8 D	N4.1 ■ 58 G	N4.2 ■ 50 G

DCON MS v toleranci h9.

Produkt	DC_2 (mm)	DC_1 (mm)	LCF (mm)	OAL (mm)	DCON MS (mm)	NOF
G3356.3	6.30	1.60	6.8	45.0	5.00	3
G3358.0	8.00	2.00	8.5	50.0	6.00	3
G33510.0	10.00	2.50	7.6	50.0	6.00	3
G33512.5	12.50	3.20	11.7	56.0	8.00	3
G33516.0	16.00	4.00	14.5	63.0	10.00	3
G33520.0	20.00	5.00	17.5	67.0	10.00	3
G33525.0	25.00	6.30	20.5	71.0	10.00	3



G137



HSS Záhlubník 60° s kuželovou stopkou, Leštěný

Leštěný záhlubník 60° pro zahlubování otvorů pro speciální šrouby a srážení hran u vyvrtaných otvorů. Kuželová stopka umožňuje použití pro stroje, kde se záhlubník upíná přímo do vřetene. Vhodný pro zahlubování otvorů v mnoha materiálech.

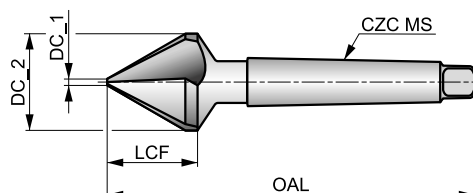

HSS	Bright	DIN 334D
R	60°	

Skupiny obráběných materiálů, startovní řezná rychlost (Vc m/min) a kód posuvu. Tabulku s posuvem na otáčku naleznete od strany 251.

P1.1 ■ 23 E	P1.2 ■ 26 E	P1.3 ■ 27 E	P2.1 ■ 20 E	P2.2 ■ 18 D	P2.3 ▣ 16 B	P3.1 ■ 16 D	P3.2 ▣ 13 D	P3.3 ▣ 11 B	P4.1 ■ 10 D	P4.2 ▣ 8 B	M1.1 ▣ 8 C	M1.2 ▣ 6 C	M2.1 ▣ 7 C
M2.2 ▣ 6 C	K1.1 ▣ 20 F	K1.2 ▣ 15 D	K2.1 ▣ 21 C	K2.2 ▣ 17 C	K3.1 ▣ 18 C	K3.2 ▣ 14 C	K5.1 ▣ 19 C	K5.2 ▣ 15 C	N1.1 ▣ 40 G	N1.2 ■ 30 G	N1.3 ▣ 20 F	N2.1 ■ 20 F	N2.2 ▣ 18 F
N3.1 ■ 21 F	N3.2 ■ 12 F	N3.3 ▣ 6 D	N4.1 ▣ 40 G	N4.2 ▣ 35 G									

Produkt	DC_2 (mm)	DC_1 (mm)	LCF (mm)	OAL (mm)	CZC MS	NOF
G13716.0	16.00	4.00	14.5	90.0	MK 1	3
G13720.0	20.00	5.00	17.5	106.0	MK 2	3
G13725.0	25.00	6.30	20.0	112.0	MK 2	3
G13731.5	31.50	10.00	23.0	118.0	MK 2	3
G13740.0	40.00	12.50	28.5	150.0	MK 3	3
G13750.0	50.00	16.00	36.0	160.0	MK 3	3
G13763.0	63.00	20.00	43.0	190.0	MK 4	3
G13780.0	80.00	25.00	54.0	200.0	MK 4	3



G154



HSS Záhlubník 82° s válcovou stopkou, Leštěný

Záhlubník 82° pro hlavy šroubů s rovnou hlavou a pro zahlubování otvorů. Univerzální nástroj, který může být použit jako strojní i pro upínání do ručního nářadí. Vhodný pro širokou oblast obráběných materiálů.

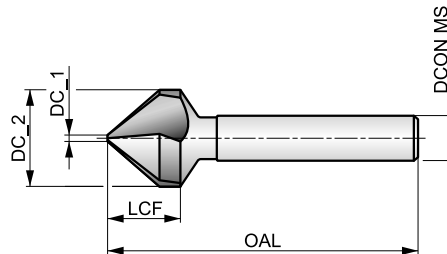

HSS	Bright	DIN 335C
R	82°	

Skupiny obráběných materiálů, startovní řezná rychlost (Vc m/min) a kód posuvu. Tabulku s posuvem na otáčku naleznete od strany 251.

P1.1 ■ 23 E	P1.2 ■ 26 E	P1.3 ■ 27 E	P2.1 ■ 20 E	P2.2 ■ 18 D	P2.3 ▧ 16 B	P3.1 ■ 16 D	P3.2 ■ 13 D	P3.3 ▧ 11 B	P4.1 ■ 10 D	P4.2 ▧ 8 B	M1.1 ▧ 8 C	M1.2 ▧ 6 C	M2.1 ▧ 7 C
M2.2 ▧ 16 C	K1.1 ▧ 20 F	K1.2 ▧ 15 D	K2.1 ▧ 21 C	K2.2 ▧ 17 C	K3.1 ▧ 18 C	K3.2 ▧ 14 C	K5.1 ▧ 14 C	K5.2 ▧ 10 C	N1.1 ▧ 40 G	N1.2 ■ 30 G	N1.3 ▧ 20 F	N2.1 ■ 20 F	N2.2 ▧ 18 F
N3.1 ■ 21 F	N3.2 ■ 12 F	N3.3 ▧ 6 D	N4.1 ▧ 40 G	N4.2 ▧ 35 G									

DCON MS v toleranci h9.

Produkt	DC_2 (mm)	DC_1 (mm)	LCF (mm)	OAL (mm)	DCON MS (mm)	NOF
G1546.3	6.30	1.50	5.5	45.0	5.00	3
G1548.3	8.30	2.00	6.5	50.0	6.00	3
G15410.4	10.40	2.50	7.6	50.0	6.00	3
G15412.4	12.40	2.80	8.5	56.0	8.00	3
G15416.5	16.50	3.20	10.5	60.0	10.00	3
G15420.5	20.50	3.50	13.0	63.0	10.00	3
G15425.0	25.00	3.80	15.5	67.0	10.00	3



G129



HSS Záhlubník 90°, Jednobřítý s válcovou stopkou, Leštěný

Leštěný záhlubník 90° pro zahlubování běžných otvorů a srážení hran u vyvrtaných otvorů. Geometrie s jedním břitem snižuje vibrace a zajišťuje hladký řez. Vhodný pro měkké nízkouhlíkové oceli a středně pevné neželezné kovy.

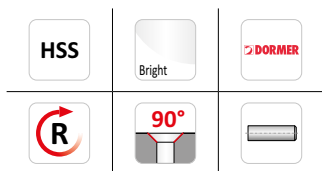
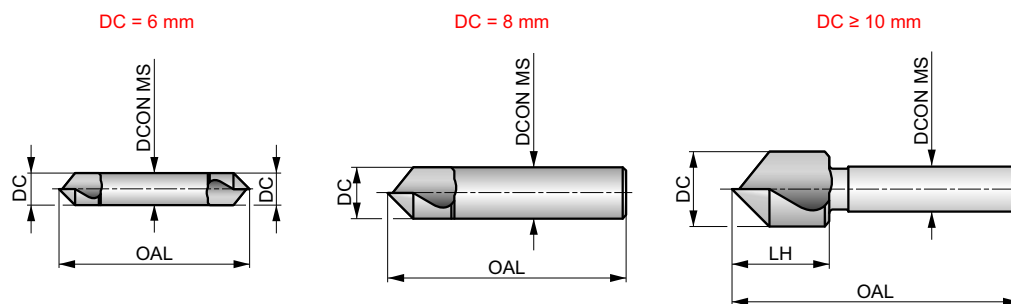

Skupiny obráběných materiálů, startovní řezná rychlost (Vc m/min) a kód posuvu. Tabulku s posuvem na otáčku naleznete od strany 251.

P1.1 ■ 21 D	P1.2 ■ 24 D	P1.3 ■ 25 D	P2.1 ■ 18 D	P2.2 ■ 16 C	P2.3 ▣ 14 A	P3.1 ■ 13 B	P3.2 ▣ 11 B	M1.1 ▣ 8 B	M1.2 ▣ 6 B	M2.1 ▣ 7 B	K1.1 ▣ 18 D	K1.2 ▣ 13 C	K2.1 ▣ 19 A
K2.2 ▣ 15 A	K3.1 ▣ 16 A	K3.2 ▣ 12 A	N1.1 ■ 34 D	N1.2 ■ 25 D	N1.3 ▣ 16 C	N2.1 ▣ 16 C	N2.2 ▣ 14 C	N3.1 ■ 17 C	N3.2 ■ 9 C	N3.3 ▣ 5 B	N4.1 ▣ 35 D	N4.2 ▣ 30 D	

DCON MS v toleranci h9.

Produkt	DC (mm)	LH (mm)	OAL (mm)	DCON MS (mm)	NOF
G1296.0	6.00	–	45.0	6.00	1
G1298.0	8.00	–	50.0	8.00	1
G12910.0	10.00	17.0	49.0	8.00	1
G12912.5	12.50	17.0	49.0	8.00	1
G12916.0	16.00	20.0	56.0	10.00	1
G12920.0	20.00	24.0	60.0	10.00	1
G12925.0	25.00	25.0	75.0	12.00	1
G12931.5	31.50	29.0	80.0	12.00	1



G149



HSS-E Záhlubník 90° s otvorem a válcovou stopkou, Leštěný

Záhlubník 90° pro zahlubování bežných otvorů a srážení hran u vyvrtných otvorů. Speciální geometrie s otvorem směřuje třísku od bříty a zajišťuje hladký řez. Vhodný pro širokou oblast obráběných materiálů.

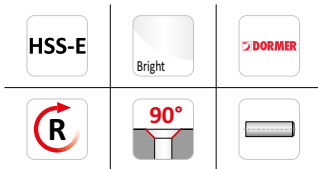
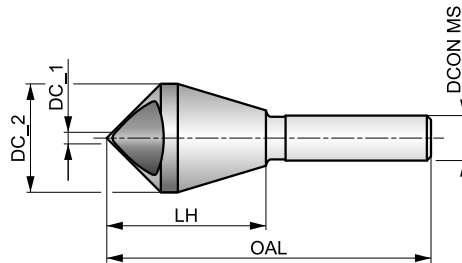

Skupiny obráběných materiálů, startovní řezná rychlost (Vc m/min) a kód posuvu. Tabulku s posuvem na otáčku naleznete od strany 251.

P1.1 ▣21 D	P1.2 ▣24 D	P1.3 ▣25 D	P2.1 ▣18 D	P2.2 ▣16 C	P2.3 ▣14 A	P3.1 ▣16 B	P3.2 ▣13 B	M1.1 ▣8 B	M1.2 ▣6 B	M2.1 ▣7 B	K1.1 ▣18 D	K2.1 ▣19 A	K3.1 ▣16 A
K5.1 ▣14 A	N1.1 ▣34 D	N1.2 ▣25 D	N1.3 ▣16 C	N2.1 ▣16 C	N2.2 ▣14 C	N3.1 ▣17 C	N3.2 ▣9 C	N3.3 ▣5 B	N4.1 ▣17 D	N4.2 ▣5 D			

Produkt	DC_2 (mm)	DC_1 (mm)	LH (mm)	OAL (mm)	DCON MS (mm)	DC (mm)	NOF
G1495	5.00	2.00	19.0	45.0	6.00	10.00	1
G14910	10.00	5.00	23.0	48.0	8.00	14.00	1
G14915	15.00	10.00	34.0	65.0	10.00	21.00	1
G14920	20.00	15.00	43.0	84.0	12.00	28.00	1
G14925	25.00	20.00	48.0	102.0	15.00	35.00	1
G14930	30.00	25.00	61.0	115.0	15.00	44.00	1
G14935	35.00	30.00	65.0	127.0	15.00	48.00	1
G14940	40.00	35.00	66.0	136.0	15.00	53.00	1
G14950	50.00	40.00	85.0	166.0	20.00	60.00	1



G136



HSS Záhlubník 90° s válcovou stopkou, Leštěný

Záhlubník 90° pro zahlubování běžných otvorů a srážení hran u vyvrtaných otvorů. Univerzální nástroj, který může být použit jako strojní i pro upínání do ručního nářadí. Zúžená stopka pro možnost zahlubování větších otvorů i při použití standartních upínačů a sklíčidel. Vhodný pro širokou oblast obráběných materiálů.

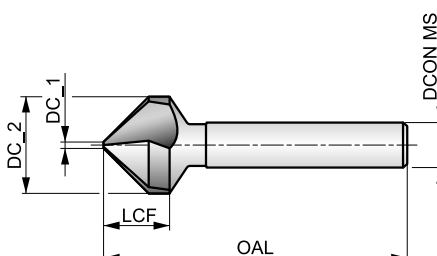

HSS	Bright	DIN 335C
R	90°	

Skupiny obráběných materiálů, startovní řezná rychlost (Vc m/min) a kód posuvu. Tabulku s posuvem na otáčku naleznete od strany 251.

P1.1 ■ 23 E	P1.2 ■ 26 E	P1.3 ■ 27 E	P2.1 ■ 20 E	P2.2 ■ 18 D	P2.3 ■ 16 B	P3.1 ■ 16 D	P3.2 ■ 13 D	P3.3 ■ 11 B	P4.1 ■ 10 D	P4.2 ■ 8 B	M1.1 ■ 8 C	M1.2 ■ 6 C	M2.1 ■ 7 C
M2.2 ■ 16 C	K1.1 ■ 20 F	K1.2 ■ 15 D	K2.1 ■ 21 C	K2.2 ■ 17 C	K3.1 ■ 18 C	K3.2 ■ 14 C	K5.1 ■ 19 C	K5.2 ■ 15 C	N1.1 ■ 40 G	N1.2 ■ 30 G	N1.3 ■ 20 F	N2.1 ■ 20 F	N2.2 ■ 18 F
N3.1 ■ 21 F	N3.2 ■ 12 F	N3.3 ■ 6 D	N4.1 ■ 40 G	N4.2 ■ 35 G									

DCON MS v toleranci h9.

Produkty nabízíme i v sadě. Vyhledejte G236.

Produkt	DC_2	DC_1	LCF	OAL	DCON MS	NOF
	(mm)	(mm)	(mm)	(mm)	(mm)	
G1364.3	4.30	1.30	4.0	40.0	4.00	3
G1365.0	5.00	1.50	4.5	40.0	4.00	3
G1365.3	5.30	1.50	4.5	40.0	4.00	3
G1365.8	5.80	1.50	5.0	45.0	5.00	3
G1366.0	6.00	1.50	5.0	45.0	5.00	3
G1366.3	6.30	1.50	5.5	45.0	5.00	3
G1367.0	7.00	1.80	5.5	50.0	6.00	3
G1367.3	7.30	1.80	6.1	50.0	6.00	3
G1368.0	8.00	2.00	6.1	50.0	6.00	3
G1368.3	8.30	2.00	6.5	50.0	6.00	3
G1369.4	9.40	2.20	7.2	50.0	6.00	3
G13610.0	10.00	2.50	7.6	50.0	6.00	3
G13610.4	10.40	2.50	7.6	50.0	6.00	3

Produkt	DC_2	DC_1	LCF	OAL	DCON MS	NOF
	(mm)	(mm)	(mm)	(mm)	(mm)	
G13611.5	11.50	2.80	8.0	56.0	8.00	3
G13612.4	12.40	2.80	8.5	56.0	8.00	3
G13613.4	13.40	2.90	9.0	56.0	8.00	3
G13615.0	15.00	3.20	9.5	60.0	10.00	3
G13616.5	16.50	3.20	10.5	60.0	10.00	3
G13619.0	19.00	3.50	11.7	63.0	10.00	3
G13620.5	20.50	3.50	13.0	63.0	10.00	3
G13623.0	23.00	3.80	13.7	67.0	10.00	3
G13625.0	25.00	3.80	15.5	67.0	10.00	3
G13626.0	26.00	3.80	15.5	67.0	10.00	3
G13628.0	28.00	4.00	16.5	71.0	12.00	3
G13630.0	30.00	4.20	18.5	71.0	12.00	3
G13631.0	31.00	4.20	18.5	71.0	12.00	3



G560



HSS Záhlubník 90° s válcovou stopkou, Povlakovaný TiAIN

Záhlubník 90° pro zahlubování běžných otvorů a srážení hran u vyvrtaných otvorů. Univerzální nástroj povlakovaný TiAIN pro zvýšení výkonu a prodloužení životnosti. Může být použit jako strojní i pro upínání do ručního nářadí. Zúžená stopka pro možnost zahlubování větších otvorů i při použití standardních upínačů a sklíčidel. Vhodný pro širokou oblast obráběných materiálů.

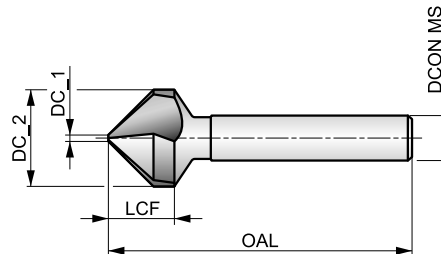

HSS	TiAIN	DIN 335C
R	90°	

Skupiny obráběných materiálů, startovní řezná rychlost (Vc m/min) a kód posuvu. Tabulku s posuvem na otáčku naleznete od strany 251.

P1.1 ■ 40 E	P1.2 ■ 45 E	P1.3 ■ 46 E	P2.1 ■ 34 E	P2.2 ■ 30 D	P2.3 ■ 27 B	P3.1 ■ 28 D	P3.2 ■ 22 D	P3.3 ■ 19 B	P4.1 ■ 16 D	P4.2 ■ 14 B	P4.3 ■ 11 B	M1.1 ■ 11 C	M1.2 ■ 9 C
M2.1 ■ 10 C	M2.2 ■ 9 C	M2.3 ■ 8 B	K1.1 ■ 41 F	K1.2 ■ 30 D	K1.3 ■ 23 D	K2.1 ■ 42 C	K2.2 ■ 34 C	K2.3 ■ 27 C	K3.1 ■ 37 C	K3.2 ■ 28 C	K3.3 ■ 23 C	K4.1 ■ 34 C	K4.2 ■ 26 C
K4.3 ■ 19 C	K5.1 ■ 39 C	K5.2 ■ 29 C	K5.3 ■ 23 C	N1.1 ■ 60 G	N1.2 ■ 45 G	N1.3 ■ 30 F	N2.1 ■ 30 F	N2.2 ■ 27 F	N2.3 ■ 19 F	N3.1 ■ 32 F	N3.2 ■ 18 F	N3.3 ■ 19 D	N4.1 ■ 62 G
N4.2 ■ 15 G													

DCON MS v toleranci h9.

Produkty nabízíme i v sadě. Vyhledejte G236.

Produkt	DC_2 (mm)	DC_1 (mm)	LCF (mm)	OAL (mm)	DCON MS (mm)	NOF
G5606.3	6.30	1.50	5.5	45.0	5.00	3
G5608.0	8.00	2.00	6.1	50.0	6.00	3
G5608.3	8.30	2.00	6.5	50.0	6.00	3
G56010.0	10.00	2.50	7.6	50.0	6.00	3
G56010.4	10.40	2.50	7.6	50.0	6.00	3
G56012.4	12.40	2.80	8.5	56.0	8.00	3
G56016.5	16.50	3.20	10.5	60.0	10.00	3
G56020.5	20.50	3.50	13.0	63.0	10.00	3
G56025.0	25.00	3.80	15.5	67.0	10.00	3
G56031.0	31.00	4.20	18.5	71.0	12.00	3



G106



HSS Záhlubník 90° s tříhrannou upínací stopkou, Leštěný

Záhlubník 90° pro zahlubování běžných otvorů a srážení hran na vrтанých otvorech. Stopka se třemi broušenými ploškami zlepšuje upnutí v tříčelistových vrtacích sklíčidlech. Vhodný pro širokou oblast obráběných materiálů.

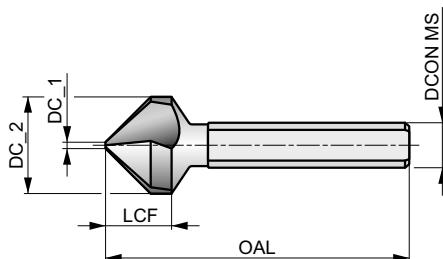

HSS	Bright	DIN 335C
R	90°	

Skupiny obráběných materiálů, startovní řezná rychlost (Vc m/min) a kód posuvu. Tabulku s posuvem na otáčku naleznete od strany 251.

P1.1 ■ 23 E	P1.2 ■ 26 E	P1.3 ■ 27 E	P2.1 ■ 20 E	P2.2 ■ 18 D	P2.3 ▣ 16 B	P3.1 ■ 16 D	P3.2 ■ 13 D	P3.3 ▣ 11 B	P4.1 ■ 10 D	P4.2 ▣ 8 B	M1.1 ▣ 8 C	M1.2 ▣ 6 C	M2.1 ▣ 7 C
M2.2 ▣ 6 C	K1.1 ■ 20 F	K1.2 ■ 15 D	K2.1 ▣ 21 C	K2.2 ▣ 17 C	K3.1 ▣ 18 C	K3.2 ▣ 14 C	K5.1 ▣ 19 C	K5.2 ▣ 15 C	N1.1 ▣ 40 G	N1.2 ■ 30 G	N1.3 ▣ 20 F	N2.1 ▣ 20 F	N2.2 ▣ 18 F
N3.1 ■ 21 F	N3.2 ▣ 12 F	N3.3 ▣ 6 D	N4.1 ▣ 40 G	N4.2 ▣ 35 G									

DCON MS v toleranci h9.

Produkty nabízíme i v sadě. Vyhledejte G236.

Produkt	DC_2 (mm)	DC_1 (mm)	LCF (mm)	OAL (mm)	DCON MS (mm)	NOF
G1066.3	6.30	1.50	5.6	45.0	5.00	3
G1068.3	8.30	2.00	6.9	50.0	6.00	3
G10610.4	10.40	2.50	7.8	50.0	6.00	3
G10612.4	12.40	2.80	8.6	56.0	8.00	3
G10616.5	16.50	3.20	11.1	60.0	10.00	3
G10620.5	20.50	3.50	12.9	63.0	10.00	3
G10625.0	25.00	3.80	15.7	67.0	10.00	3
G10631.0	31.00	4.20	18.5	71.0	12.00	3
G10634.0	34.00	4.50	19.0	103.0	16.00	3
G10637.0	37.00	4.50	21.2	118.0	16.00	3
G10640.0	40.00	4.50	20.0	118.0	16.00	3
G10650.0	50.00	5.00	23.6	126.0	16.00	3



G506



HSS Záhlubník 90° s tříhrannou upínací stopkou, Povlakovaný TiAlN

Záhlubník 90° pro zahlubování běžných otvorů a srážení hran na vrtaných otvorech. Stopka se třemi broušenými ploškami zlepšuje upnutí v tříčelistových vrtacích sklíčidlech, zejména pokud je použito ruční nářadí. Povlak TiAlN pro zvýšení výkonu a prodloužení životnosti. Vhodný pro širokou oblast obráběných materiálů.

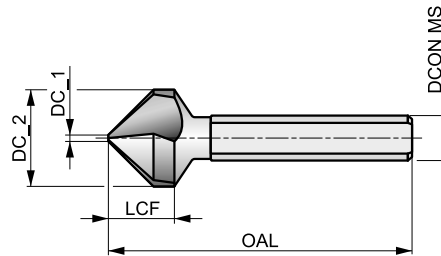

HSS	TiAlN	DIN 335C
R	90°	

Skupiny obráběných materiálů, startovní řezná rychlost (Vc m/min) a kód posuvu. Tabulku s posuvem na otáčku naleznete od strany 251.

P1.1 ■ 40 E	P1.2 ■ 45 E	P1.3 ■ 46 E	P2.1 ■ 34 E	P2.2 ■ 30 D	P2.3 ■ 27 B	P3.1 ■ 28 D	P3.2 ■ 22 D	P3.3 ■ 19 B	P4.1 ■ 16 D	P4.2 ■ 14 B	P4.3 ▣ 11 B	M1.1 ▣ 11 C	M1.2 ▣ 9 C
M2.1 ▣ 10 C	M2.2 ▣ 9 C	M2.3 ▣ 8 B	K1.1 ■ 41 F	K1.2 ■ 30 D	K1.3 ▣ 23 D	K2.1 ■ 42 C	K2.2 ■ 34 C	K2.3 ▣ 27 C	K3.1 ■ 37 C	K3.2 ■ 28 C	K3.3 ▣ 23 C	K4.1 ▣ 34 C	K4.2 ▣ 26 C
K4.3 ▣ 19 C	K5.1 ■ 39 C	K5.2 ■ 29 C	K5.3 ▣ 23 C	N1.1 ▣ 60 G	N1.2 ▣ 45 G	N1.3 ■ 30 F	N2.1 ■ 30 F	N2.2 ■ 27 F	N2.3 ■ 19 F	N3.1 ■ 32 F	N3.2 ■ 18 F	N3.3 ▣ 19 D	N4.1 ▣ 62 G
N4.2 ▣ 55 G													

DCON MS v toleranci h9.

Produkty nabízíme i v sadě. Vyhledejte G236.

Produkt	DC_2	DC_1	LCF	OAL	DCON MS	NOF
	(mm)	(mm)	(mm)	(mm)	(mm)	
G5066.3	6.30	1.50	5.6	45.0	5.00	3
G5068.3	8.30	2.00	6.9	50.0	6.00	3
G50610.4	10.40	2.50	7.8	50.0	6.00	3
G50612.4	12.40	2.80	8.6	56.0	8.00	3
G50616.5	16.50	3.20	11.1	60.0	10.00	3
G50620.5	20.50	3.50	12.9	63.0	10.00	3
G50625.0	25.00	3.80	15.7	67.0	10.00	3
G50631.0	31.00	4.20	18.5	71.0	12.00	3
G50634.0	34.00	4.50	19.0	103.0	16.00	3
G50637.0	37.00	4.50	21.2	118.0	16.00	3
G50640.0	40.00	4.50	20.0	118.0	16.00	3
G50650.0	50.00	5.00	23.6	126.0	16.00	3



G142



HSS Záhlubník 90° s válcovou stopkou, Leštěný, pro nerez oceli

Záhlubník 90° pro zahlubování bežných otvorů a srážení hran u vyvrtaných otvorů. Zvětšené podbroušení pro ostřejší břit zlepšuje řezný proces v materiálech s tendencí k nalepování třísek (nerez oceli a nezelezné kovy). Může být použit jako strojní i pro upínání do ručního nářadí.

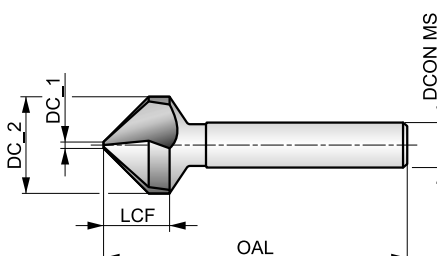

HSS	Bright	DIN 335C
R	90°	

Skupiny obráběných materiálů, startovní řezná rychlost (Vc m/min) a kód posuvu. Tabulku s posuvem na otáčku naleznete od strany 251.

P1.1 ■ 23 E	P1.2 ■ 26 E	P1.3 ■ 27 E	P2.1 ■ 20 E	P2.2 ■ 18 D	P2.3 ▣ 16 B	P3.1 ■ 16 D	P3.2 ■ 13 D	P3.3 ▣ 11 B	P4.1 ■ 10 D	P4.2 ▣ 8 B	M1.1 ■ 11 C	M1.2 ■ 9 C	M2.1 ■ 10 C
M2.2 ▣ 8 C	M3.1 ■ 7 B	M3.2 ▣ 6 B	M4.1 ▣ 4 A	N1.1 ■ 40 G	N1.2 ■ 30 G	N1.3 ▣ 20 F	N2.1 ▣ 20 F	N2.2 ▣ 18 F	N2.3 ▣ 20 F	N3.1 ■ 34 F	N3.2 ■ 20 F	N3.3 ■ 10 D	N4.1 ■ 40 G
N4.2 ■ 35 G													

DCON MS v toleranci h9.

Produkt	DC_2 (mm)	DC_1 (mm)	LCF (mm)	OAL (mm)	DCON MS (mm)	NOF
G1424.8	4.80	1.30	4.5	40.0	4.00	3
G1425.0	5.00	1.50	4.5	40.0	4.00	3
G1426.0	6.00	1.50	5.0	45.0	5.00	3
G1426.3	6.30	1.50	5.5	45.0	5.00	3
G1427.0	7.00	1.80	5.5	50.0	6.00	3
G1427.3	7.30	1.80	6.1	50.0	6.00	3
G1428.0	8.00	2.00	6.1	50.0	6.00	3
G1428.3	8.30	2.00	6.5	50.0	6.00	3
G14210.0	10.00	2.50	7.6	50.0	6.00	3
G14210.4	10.40	2.50	7.6	50.0	6.00	3
G14211.5	11.50	2.80	8.0	56.0	8.00	3
G14212.4	12.40	2.80	8.5	56.0	8.00	3
G14215.0	15.00	3.20	9.5	60.0	10.00	3
G14216.5	16.50	3.20	10.5	60.0	10.00	3
G14219.0	19.00	3.50	11.7	63.0	10.00	3
G14220.5	20.50	3.50	13.0	63.0	10.00	3
G14223.0	23.00	3.80	13.7	67.0	10.00	3
G14225.0	25.00	3.80	15.5	67.0	10.00	3
G14231.0	31.00	4.20	18.5	71.0	12.00	3



G570



HSS-E Záhlučník 90° s válcovou stopkou, Povlakovaný AlTiCN

Záhlučník 90° pro zahlubování běžných otvorů a srážení hran u vyvrtaných otvorů. Může být použit jako strojní i pro upínání do ručního nářadí. Vhodný zejména pro zahlubování otvorů v tvrdých a abrazivních materiálech. Povlak AlTiCN pro vyšší výkon a prodloužení životnosti.

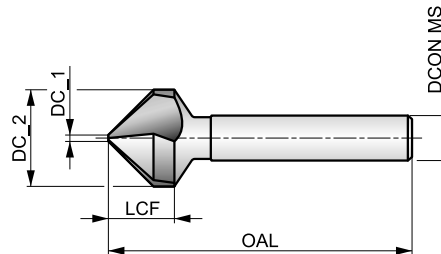

HSS-E	AlTiCN	DIN 335C
R	90°	

Skupiny obráběných materiálů, startovní řezná rychlost (Vc m/min) a kód posuvu. Tabulku s posuvem na otáčku naleznete od strany 251.

P1.1 ■ 40 E	P1.2 ■ 45 E	P1.3 ■ 46 E	P2.1 ■ 34 E	P2.2 ■ 30 D	P2.3 ■ 27 B	P3.1 ■ 28 D	P3.2 ■ 22 D	P3.3 ■ 19 B	P4.1 ■ 16 D	P4.2 ■ 14 B	P4.3 ■ 11 B	M1.1 ■ 23 C	M1.2 ■ 20 C
M2.1 ■ 21 C	M2.2 ■ 17 C	M2.3 ■ 14 A	M3.1 ■ 14 B	M3.2 ■ 12 B	M3.3 ■ 11 B	M4.1 ■ 15 A	M4.2 ■ 13 A	K1.1 ■ 41 C	K1.2 ■ 30 C	K1.3 ■ 23 C	K2.1 ■ 42 C	K2.2 ■ 34 C	K2.3 ■ 27 C
K3.1 ■ 37 C	K3.2 ■ 28 C	K3.3 ■ 23 C	K4.1 ■ 34 C	K4.2 ■ 26 C	K4.3 ■ 19 C	K5.1 ■ 39 C	K5.2 ■ 29 C	K5.3 ■ 23 C	N1.1 ■ 60 G	N1.2 ■ 45 G	N1.3 ■ 30 F	N2.1 ■ 30 F	N2.2 ■ 27 F
N2.3 ■ 19 F	N3.1 ■ 32 F	N3.2 ■ 18 F	N3.3 ■ 9 D										

DCON MS v toleranci h9.

Produkt	DC_2 (mm)	DC_1 (mm)	LCF (mm)	OAL (mm)	DCON MS (mm)	NOF
G5706.3	6.30	1.50	6.5	45.0	5.00	3
G5708.3	8.30	2.00	8.2	50.0	6.00	3
G57010.4	10.40	2.50	9.7	50.0	6.00	3
G57012.4	12.40	2.80	10.6	56.0	8.00	3
G57016.5	16.50	3.20	13.9	60.0	10.00	3
G57020.5	20.50	3.50	17.1	63.0	10.00	3
G57025.0	25.00	3.80	21.4	67.0	10.00	3
G57031.0	31.00	4.20	24.4	71.0	12.00	3



G107



HSS-E Záhlubník 90°, Šestihránná stopka, Leštěný

Univerzální záhlubník se šestihránnou stopkou pro snadnější upínání. 90° záhlubník pro sražení hran a oťepů u vyvrtaných otvorů. Vhodný pro širokou oblast obráběných materiálů.

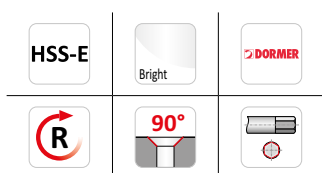
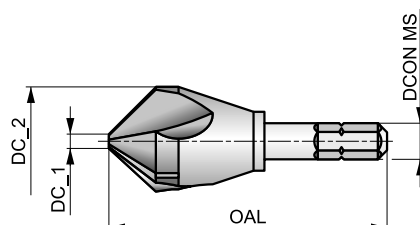

Skupiny obráběných materiálů, startovní řezná rychlost (Vc m/min) a kód posuvu. Tabulku s posuvem na otáčku naleznete od strany 251.

P1.1 ■ 23 E	P1.2 ■ 26 E	P1.3 ■ 27 E	P2.1 ■ 20 E	P2.2 ■ 18 D	P2.3 ▣ 16 B	P3.1 ■ 16 D	P3.2 ■ 13 D	P3.3 ▣ 11 B	P4.1 ■ 10 D	P4.2 ▣ 8 B	M1.1 ▣ 11 C	M1.2 ▣ 9 C	M2.1 ▣ 10 C
M2.2 ▣ 9 C	M2.3 ▣ 8 B	K1.1 ■ 20 F	K1.2 ▣ 15 D	K2.1 ■ 21 C	K2.2 ▣ 17 C	K3.1 ■ 18 C	K3.2 ▣ 14 C	K4.1 ▣ 15 C	K5.1 ■ 19 C	K5.2 ▣ 15 C	N1.1 ▣ 40 G	N1.2 ■ 30 G	N1.3 ▣ 20 F
N2.1 ▣ 20 F	N2.2 ▣ 18 F	N2.3 ▣ 20 F	N3.1 ■ 21 F	N3.2 ▣ 12 F	N3.3 ▣ 6 D	N4.1 ▣ 40 G	N4.2 ▣ 35 G						

6,35; Šestihránná stopka 1/4"; DIN 74.

Produkt	DC_2	DC_1	OAL	DCONMS	CZC MS	NOF
	(mm)	(mm)	(mm)	(inch)		
G1076.3	6.30	1.50	50.0	1/4"	M2-M3	3
G1078.3	8.30	2.00	50.0	1/4"	M4	3
G10710.4	10.40	2.50	50.0	1/4"	M5	3
G10712.4	12.40	2.80	50.0	1/4"	M6	3
G10716.5	16.50	3.20	50.0	1/4"	M8	3
G10720.5	20.50	3.50	50.0	1/4"	M10	3



G600



HSS Záhlubník 90°, Extra dlouhý, Leštěný

Prodloužená stopka dává možnost zahlubit otvory v těžko přístupných místech. 90° záhlubník pro zahlubování standardních otvorů pro šrouby a pro srážení hran. Vhodný pro širokou oblast obráběných materiálů.

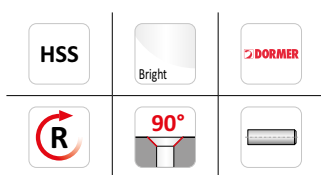
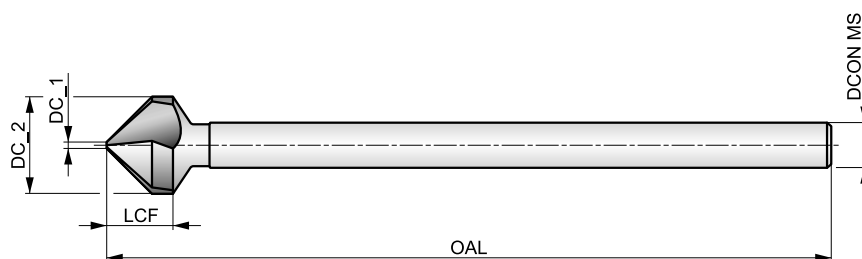

Skupiny obráběných materiálů, startovní řezná rychlost (Vc m/min) a kód posuvu. Tabulku s posuvem na otáčku naleznete od strany 251.

P1.1 ■ 20 E	P1.2 ■ 22 E	P1.3 ■ 23 E	P2.1 ■ 17 E	P2.2 ■ 15 D	P2.3 ■ 13 B	P3.1 ■ 12 D	P3.2 ■ 9 D	P3.3 ■ 8 B	P4.1 ■ 7 D	P4.2 ■ 6 B	M1.1 ■ 8 C	M1.2 ■ 6 C	M2.1 ■ 7 C
M2.2 ■ 16 C	K1.1 ■ 17 E	K1.2 ■ 12 C	K2.1 ■ 18 B	K2.2 ■ 14 B	K3.1 ■ 15 B	K3.2 ■ 11 B	K5.1 ■ 16 B	K5.2 ■ 12 B	N1.1 ■ 35 G	N1.2 ■ 25 G	N1.3 ■ 15 F	N2.1 ■ 15 F	N2.2 ■ 13 F
N3.1 ■ 16 E	N3.2 ■ 10 E	N3.3 ■ 5 C											

DCON MS v toleranci h9.

Produkt	DC_2 (mm)	DC_1 (mm)	LCF (mm)	OAL (mm)	DCON MS (mm)	NOF
G6006.3	6.30	1.30	5.6	154.0	5.00	3
G6008.3	8.30	1.80	6.9	155.0	6.00	3
G60010.4	10.40	2.20	7.8	157.0	6.00	3
G60012.4	12.40	2.50	8.6	158.0	8.00	3
G60015.0	15.00	2.80	10.3	159.0	10.00	3
G60016.5	16.50	2.80	11.1	161.0	10.00	3
G60020.5	20.50	3.00	12.9	164.0	10.00	3
G60025.0	25.00	3.20	15.7	168.0	10.00	3



G132



HSS Záhlubník 90° s válcovou stopkou a zvýšeným počtem břitů, Leštěný

Záhlubník 90° pro zahlubování běžných otvorů a srážení hran u vyvrtaných otvorů. Zvýšený počet drážek pro snížení možnosti vibrací a hladší řez. Může být použit jako strojní i pro upínání do ručního nářadí. Vhodný pro širokou oblast obráběných materiálů.

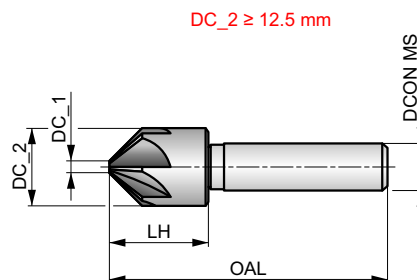
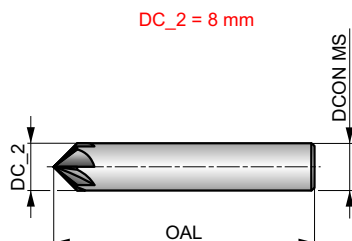

HSS	Bright	DIN 335A
R	90°	

Skupiny obráběných materiálů, startovní řezná rychlost (Vc m/min) a kód posuvu. Tabulku s posuvem na otáčku naleznete od strany 251.

P2.2 ▣ 18 E	P2.3 ▣ 16 D	P3.2 ▣ 13 D	P3.3 ▣ 11 B	P4.1 ▣ 10 D	P4.2 ▣ 8 C	P4.3 ▣ 7 B	M3.3 ▣ 3 A	M4.1 ▣ 4 A	K1.1 ▣ 20 F	K1.2 ▣ 15 D	K1.3 ▣ 11 D	K2.2 ▣ 17 C	K2.3 ▣ 14 D
K3.1 ▣ 18 E	K3.2 ▣ 14 E	K3.3 ▣ 11 D	K4.1 ▣ 17 C	K4.2 ▣ 13 C	K5.1 ▣ 19	K5.2 ▣ 15	K5.3 ▣ 11 D	N1.3 ▣ 20 F	N2.3 ▣ 13 F	N3.2 ▣ 12 F	N4.3 ▣ 5 G		

DCON MS v toleranci h9.

Produkt	DC_2 (mm)	DC_1 (mm)	LH (mm)	OAL (mm)	DCON MS (mm)	NOF
G1328.0	8.00	–	–	48.0	8.00	5
G13212.5	12.50	2.00	15.5	48.0	8.00	5
G13216.0	16.00	3.20	19.5	56.0	10.00	7
G13220.0	20.00	5.00	23.0	60.0	10.00	7



G138



HSS Záhlubník 90° s kuželovou stopkou, Leštěný

Záhlubník 90° pro zahlubování běžných otvorů a srážení hran na vrтанých otvorech. Kuželová stopka umožňuje použití na strojích, kde jsou nástroje upínány přímo do vřetene. Vhodný pro širokou oblast obráběných materiálů.

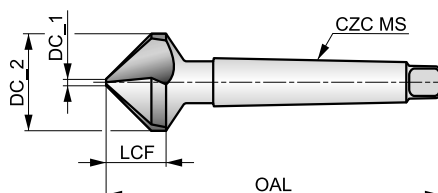

HSS	Bright	DIN 335D
R	90°	

Skupiny obráběných materiálů, startovní řezná rychlost (Vc m/min) a kód posuvu. Tabulku s posuvem na otáčku naleznete od strany 251.

P1.1 ■ 23 E	P1.2 ■ 26 E	P1.3 ■ 27 E	P2.1 ■ 20 E	P2.2 ■ 18 D	P2.3 ▧ 16 B	P3.1 ■ 16 D	P3.2 ▧ 13 D	P3.3 ▧ 11 B	P4.1 ■ 10 D	P4.2 ▧ 8 B	M1.1 ▧ 8	M1.2 ▧ 6	M2.1 ▧ 7
M2.2 ▧ 6	K1.1 ▧ 20 F	K1.2 ▧ 15 D	K2.1 ▧ 21 C	K2.2 ▧ 17 C	K3.1 ▧ 18 C	K3.2 ▧ 14 C	K5.1 ▧ 19 C	K5.2 ▧ 15 C	N1.1 ▧ 40 G	N1.2 ■ 30 G	N1.3 ▧ 20 F	N2.1 ■ 20 F	N2.2 ▧ 18 F
N3.1 ■ 21 F	N3.2 ■ 12 F	N3.3 ▧ 6 D	N4.1 ▧ 40 G	N4.2 ▧ 35 G									

Produkt	DC_2 (mm)	DC_1 (mm)	LCF (mm)	OAL (mm)	CZC MS	NOF
G13825.0	25.00	3.80	15.5	106.0	MK 2	3
G13830.0	30.00	4.20	18.5	112.0	MK 2	3
G13831.0	31.00	4.20	20.0	112.0	MK 2	3
G13834.0	34.00	4.50	19.5	118.0	MK 2	3
G13837.0	37.00	4.80	21.7	118.0	MK 2	3
G13840.0	40.00	10.00	20.5	140.0	MK 3	3
G13850.0	50.00	14.00	24.1	150.0	MK 3	3
G13863.0	63.00	16.00	28.5	180.0	MK 4	3
G13880.0	80.00	22.00	36.0	190.0	MK 4	3



G338



HSS Záhlubník 90° s kuželovou stopkou, Povlakovaný TiN

Záhlubník 90° pro zahlubování běžných otvorů a srážení hran na vrtaných otvorech. Zvýšená životnost i při vysokých řezných rychlostech. Kuželová stopka umožňuje použití na strojích, kde jsou nástroje upínány přímo do vřetene. Povlakovaný TiN pro zvýšení výkonu a prodloužení životnosti. Vhodný pro širokou oblast obráběných materiálů.

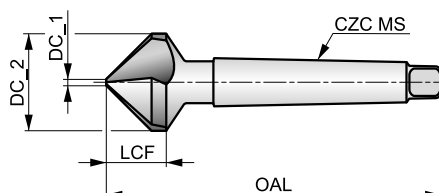

HSS	TiN	DIN 335D
R	90°	

Skupiny obráběných materiálů, startovní řezná rychlost (Vc m/min) a kód posuvu. Tabulku s posuvem na otáčku naleznete od strany 251.

P1.1 ■ 33 E	P1.2 ■ 37 E	P1.3 ■ 38 E	P2.1 ■ 28 E	P2.2 ■ 25 D	P2.3 ■ 22 B	P3.1 ■ 23 D	P3.2 ■ 18 D	P3.3 ■ 15 B	P4.1 ■ 13 D	P4.2 ■ 11 B	P4.3 ▣ 9 B	M1.1 ▣ 11 C	M1.2 ▣ 9 C
M2.1 ▣ 10 C	M2.2 ▣ 9 C	M2.3 ▣ 8 B	K1.1 ■ 34 F	K1.2 ■ 25 D	K1.3 ▣ 19 D	K2.1 ■ 35 C	K2.2 ■ 28 C	K2.3 ▣ 23 C	K3.1 ■ 31 C	K3.2 ■ 24 C	K3.3 ▣ 19 C	K4.1 ▣ 29 C	K4.2 ▣ 22 C
K4.3 ▣ 16 C	K5.1 ■ 32 C	K5.2 ■ 24 C	K5.3 ▣ 19 C	N1.1 ■ 53 G	N1.2 ■ 40 G	N1.3 ■ 27 F	N2.1 ■ 27 F	N2.2 ■ 24 F	N2.3 ■ 17 F	N3.1 ■ 28 F	N3.2 ■ 16 F	N3.3 ▣ 8 D	N4.1 ▣ 58 G
N4.2 ▣ 50 G													

Produkt	DC_2 (mm)	DC_1 (mm)	LCF (mm)	OAL (mm)	CZC MS	NOF
G33825.0	25.00	3.80	15.5	106.0	MK 2	3
G33831.0	31.00	4.20	20.0	112.0	MK 2	3
G33837.0	37.00	4.80	21.7	118.0	MK 2	3
G33840.0	40.00	10.00	20.5	140.0	MK 3	3
G33850.0	50.00	14.00	24.1	150.0	MK 3	3
G33863.0	63.00	16.00	28.5	180.0	MK 4	3



G171



HSS Záhlubník 100° s válcovou stopkou, Povlakovaný TiAlN

Záhlubník 100° pro zahlubování běžných otvorů a srážení hran. Univerzální nástroj povlakovaný TiAlN pro zvýšení výkonu a prodloužení životnosti. Může být použit jako strojní i pro upínání do ručního nářadí. Vhodný pro širokou oblast obráběných materiálů.

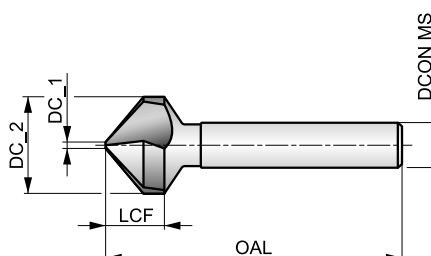

HSS	TiAlN	DIN 335C
R	100°	

Skupiny obráběných materiálů, startovní řezná rychlost (Vc m/min) a kód posuvu. Tabulku s posuvem na otáčku naleznete od strany 251.

P1.1 ■ 40 E	P1.2 ■ 45 E	P1.3 ■ 46 E	P2.1 ■ 34 E	P2.2 ■ 30 D	P2.3 ■ 27 B	P3.1 ■ 28 D	P3.2 ■ 22 D	P3.3 ■ 19 B	P4.1 ■ 16 D	P4.2 ■ 14 B	P4.3 ▣ 11 B	M1.1 ▣ 11 C	M1.2 ▣ 9 C
M2.1 ▣ 10 C	K1.1 ■ 41 F	K1.2 ■ 30 D	K1.3 ▣ 23 D	K2.1 ■ 42 C	K2.2 ■ 34 C	K2.3 ▣ 27 C	K3.1 ■ 37 C	K3.2 ■ 28 C	K3.3 ▣ 23 C	K4.1 ▣ 34 C	K4.2 ▣ 26 C	K4.3 ▣ 19 C	K5.1 ■ 39 C
K5.2 ■ 29 C	K5.3 ▣ 23 C	N1.1 ▣ 60 G	N1.2 ▣ 45 G	N1.3 ■ 30 F	N2.1 ■ 30 F	N2.2 ■ 27 F	N2.3 ■ 19 F	N3.1 ■ 32 F	N3.2 ■ 18 F	N3.3 ▣ 9 D	N4.1 ▣ 62 G	N4.2 ▣ 55 G	

DCON MS v toleranci h9.

Produkt	DC_2 (mm)	DC_1 (mm)	LCF (mm)	OAL (mm)	DCON MS (mm)	NOF
G1716.3	6.30	1.50	4.5	44.0	5.00	3
G1718.3	8.30	2.00	5.5	49.0	6.00	3
G17110.4	10.40	2.50	6.6	49.0	6.00	3
G17112.4	12.40	2.80	7.0	53.0	8.00	3
G17116.5	16.50	3.20	9.0	56.0	10.00	3
G17120.5	20.50	3.50	11.0	61.0	10.00	3
G17125.0	25.00	3.80	13.5	65.0	10.00	3



G314



HSS Kuželový záhlubník pro tenké plechy, Letěný

Postupný kuželový záhlubník pro rozšiřování otvoru v postupných krocích až na požadovaný průměr. Zúžená válcová stopka umožňuje upnutí do standardních upínačů a sklíčidel. Vhodné pro rozšiřování otvorů v mnoha tenkostěnných materiálech.

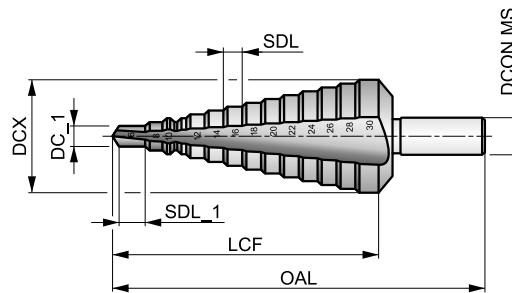

HSS	Bright	DORMER
R	20°	

Skupiny obráběných materiálů, startovní řezná rychlost (Vc m/min) a kód posuvu. Tabulku s posuvem na otáčku naleznete od strany 251.

P1.1 ■ 20	P1.2 ■ 22	P1.3 ■ 23	P2.1 ■ 17	P2.2 ■ 15	P2.3 ■ 13	P3.1 ■ 12	P3.2 ■ 9	M1.1 ■ 8	M1.2 ■ 6	M2.1 ■ 7	K1.1 ■ 17	N1.1 ■ 30	N1.2 ■ 23
N1.3 ■ 15	N2.1 ■ 31	N2.2 ■ 28	N3.1 ■ 34	N3.2 ■ 20	N3.3 ■ 10	N4.1 ■ 30	N4.2 ■ 20						

SDI = rozsah průměrů.

Produkt	Nr.	DC_1	DCX	SDL	SDI	SDL_1	LCF	OAL	DCON MS
		(mm)	(mm)	(mm)	(mm)	(mm)	(mm)	(mm)	(mm)
G314412	412	4.00	12.00	5.00	4 - 5 - 6 - 7 - 8 - 9 - 10 - 11 - 12	5.00	61.0	80.0	6.00
G3141220	1220	12.00	20.00	4.00	12 - 13 - 14 - 15 - 16 - 17 - 18 - 19 - 20	4.00	55.0	76.0	9.00
G3142030	2030	20.00	30.00	4.00	20 - 21 - 22 - 23 - 24 - 25 - 26 - 27 - 28 - 29 - 30	4.00	67.0	88.0	12.00
G3143040	3040	30.00	40.00	4.00	30 - 31 - 32 - 33 - 34 - 35 - 36 - 37 - 38 - 39 - 40	4.00	74.0	98.0	13.00
G314420	420	4.00	20.00	4.00	4 - 6 - 8 - 10 - 12 - 14 - 16 - 18 - 20	4.00	48.0	76.0	8.00
G314630	630	6.00	30.00	4.00	6 - 8 - 10 - 12 - 14 - 16 - 18 - 20 - 22 - 24 - 26 - 28 - 30	4.00	73.0	98.0	10.00
G314M	M	9.00	36.00	3.00	9 - 12 - 15 - 18 - 21 - 24 - 27 - 30 - 33 - 36	3.00	57.0	86.0	12.00



G125



HSS Záhlubník 180° s válcovou stopkou, Leštěný

Záhlubník 180°, na zahloubení otvorů pro hlavy šroubů. Záhlubník má pevnou vodící část (dostupný pro různé tolerance předvrtaných otvorů), která napomáhá vést záhlubník ve standartních metrických otvorech. Vhodný pro zahlubování otvorů v mnoha materiálech.

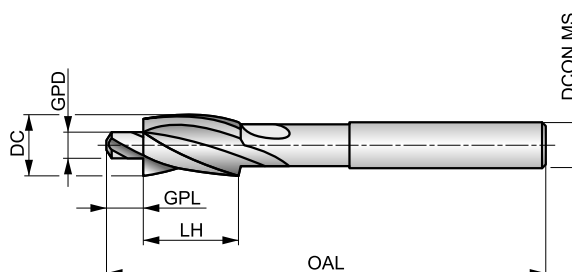

HSS	Bright	DIN 373
R	180°	

Skupiny obráběných materiálů, startovní rezná rychlost (Vc m/min) a kód posuvu. Tabulku s posuvem na otáčku naleznete od strany 251.

P1.1 ■ 20 E	P1.2 ■ 22 E	P1.3 ■ 23 E	P2.1 ■ 17 E	P2.2 ■ 15 D	P2.3 ■ 13 C	P3.1 ■ 12 D	P3.2 ■ 9 D	P3.3 ■ 8 C	P4.1 ■ 7 D	P4.2 ■ 6 C	M1.1 ■ 8 D	M1.2 ■ 6 D	M2.1 ■ 7 D
M2.2 ■ 6 D	M2.3 ■ 5 C	K1.1 ■ 17 E	K1.2 ■ 12 E	K1.3 ■ 11 E	K2.1 ■ 15 D	K2.2 ■ 12 D	K2.3 ■ 10 C	K3.1 ■ 13 D	K3.2 ■ 10 D	K4.1 ■ 12 D	K4.2 ■ 9 D	K5.1 ■ 14 D	K5.2 ■ 10 D
N1.1 ■ 30 G	N1.2 ■ 23 G	N1.3 ■ 15 G	N2.1 ■ 31 G	N2.2 ■ 28 G	N2.3 ■ 20 G	N3.1 ■ 34 C	N3.2 ■ 20 C	N3.3 ■ 10 C	N4.1 ■ 30 C	N4.2 ■ 20 C			

DCON MS v toleranci h9.

Produkt	DC (mm)	GPD (mm)	CZC MS	GPL (mm)	OAL (mm)	LH (mm)	DCON MS (mm)	NOF
G1256.5X2.5 ³⁾	6.50	2.50	M 3 t	4.50	71.0	14.0	5.00	3
G1256.5X3.2 ¹⁾	6.50	3.20	M 3 f	4.50	71.0	14.0	5.00	3
G1256.5X3.4 ²⁾	6.50	3.40	M 3 m	4.50	71.0	14.0	5.00	3
G1258.0X3.3 ³⁾	8.00	3.30	M 4 t	5.00	71.0	14.0	5.00	3
G1258.0X4.3 ¹⁾	8.00	4.30	M 4 f	5.00	71.0	14.0	5.00	3
G1258.0X4.5 ²⁾	8.00	4.50	M 4 m	5.00	71.0	14.0	5.00	3
G12510.0X4.2 ³⁾	10.00	4.20	M 5 t	5.50	80.0	18.0	8.00	3
G12510.0X5.3 ¹⁾	10.00	5.30	M 5 f	5.50	80.0	18.0	8.00	3
G12510.0X5.5 ²⁾	10.00	5.50	M 5 m	5.50	80.0	18.0	8.00	3
G12511.0X5.0 ³⁾	11.00	5.00	M 6 t	6.00	80.0	18.0	8.00	3
G12511.0X6.4 ¹⁾	11.00	6.40	M 6 f	6.00	80.0	18.0	8.00	3
G12511.0X6.6 ²⁾	11.00	6.60	M 6 m	6.00	80.0	18.0	8.00	3
G12515.0X6.8 ³⁾	15.00	6.80	M 8 t	8.00	100.0	22.0	12.50	3
G12515.0X8.4 ¹⁾	15.00	8.40	M 8 f	8.00	100.0	22.0	12.50	3
G12515.0X9.0 ²⁾	15.00	9.00	M 8 m	8.00	100.0	22.0	12.50	3
G12518.0X8.5 ³⁾	18.00	8.50	M 10 t	10.00	100.0	22.0	12.50	3
G12518.0X10.5 ¹⁾	18.00	10.50	M 10 f	10.00	100.0	22.0	12.50	3
G12518.0X11.0 ²⁾	18.00	11.00	M 10 m	10.00	100.0	22.0	12.50	3
G12520.0X10.2 ³⁾	20.00	10.20	M 12 t	10.00	100.0	22.0	12.50	3
G12520.0X13.0 ¹⁾	20.00	13.00	M 12 f	10.00	100.0	22.0	12.50	3
G12520.0X13.5 ²⁾	20.00	13.50	M 12 m	10.00	100.0	22.0	12.50	3

¹⁾ f = pro průchozí otvory, jemně.
²⁾ m = pro průchozí otvory, střední.
³⁾ t = otvor pod závit.



G236



Sada Záhlubníků v kulatém plastovém boxu

Sada obsahuje různé velikosti 90° záhlubníků. Dostupných je 5 různých sad s typy G106, G136 či G560. Vhodný pro širokou oblast obráběných materiálů.

A = typy v sadě, B = počet v sadě, C = rozměry v sadě.

Produkt	Nr.	A	B	C
G2361	1	G136	6	6.30 mm, 8.30 mm, 10.40 mm, 12.40 mm, 16.50 mm, 20.50 mm
G2362	2	G136	4	6.30 mm, 10.40 mm, 16.50 mm, 20.50 mm
G2363	3	G560	6	6.30 mm, 8.30 mm, 10.40 mm, 12.40 mm, 16.50 mm, 20.50 mm
G2364	4	G106	6	6.30 mm, 8.30 mm, 10.40 mm, 12.40 mm, 16.50 mm, 20.50 mm
G2365	5	G506	6	6.30 mm, 8.30 mm, 10.40 mm, 12.40 mm, 16.50 mm, 20.50 mm



TABULKA POSUVŮ VÝSTRUŽNÍKŮ

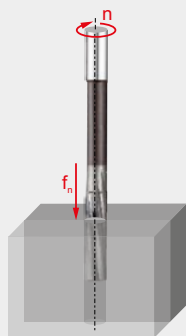

Posuv na otáčku (f_n v mm/ot)
V závislosti na pracovních podmínkách
může být nutné tyto hodnoty upravit
 $\pm 15\%$.

Jak pomoci této tabulky najít posuv na otáčku (f_n):

1. Vyhleďte svůj kód alfa na stránce produktu (například: 21C_{„C“} je alfa kód).
2. V horním řádku tabulky najdete nejbližší průměr pro vaši řeznou aplikaci.
3. Vyhleďte svůj alfa kód v levém sloupci tabulky.
4. Průsečík (buňka) průměru a alfa kódu je posuv na otáčku (f_n).

		ø DC (mm)																		
		1.00	1.50	2.00	3.00	4.00	5.00	6.00	7.00	8.00	10.00	12.00	15.00	16.00	20.00	25.00	30.00	40.00	50.00	80.00
Posuvy	A	0.030	0.045	0.055	0.078	0.090	0.100	0.125	0.137	0.150	0.170	0.185	0.210	0.220	0.250	0.280	0.320	0.390	0.440	0.500
	B	0.035	0.055	0.072	0.110	0.130	0.150	0.165	0.172	0.180	0.210	0.240	0.270	0.280	0.310	0.360	0.400	0.500	0.550	0.600
	C	0.040	0.065	0.085	0.135	0.160	0.185	0.200	0.210	0.220	0.260	0.285	0.325	0.335	0.390	0.440	0.480	0.600	0.680	0.750
	D	0.050	0.080	0.110	0.160	0.180	0.200	0.235	0.253	0.270	0.320	0.360	0.400	0.410	0.470	0.540	0.600	0.730	0.850	0.950
	E	0.065	0.100	0.140	0.180	0.215	0.250	0.300	0.325	0.350	0.390	0.430	0.485	0.500	0.530	0.640	0.750	0.910	1.100	1.200
	F	0.090	0.140	0.180	0.260	0.305	0.350	0.395	0.417	0.440	0.500	0.550	0.610	0.630	0.700	0.800	0.930	1.200	1.500	1.650

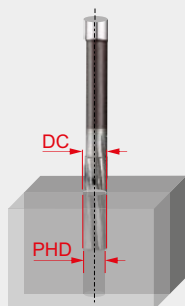

Přídavek na obrábění při použití
strojního výstružníku (MA v mm)
Průměr předvrtaného otvoru
 $PHD = DC - MA$

Jak pomoci této tabulky dosáhnout správného průměru předvrtaného otvoru (PHD):

1. V horním řádku tabulky najdete rozsah průměrů pro vaši řeznou aplikaci.
2. V levém sloupci tabulky vyhleďte kód skupiny ISO (například: U nerezové oceli je kód skupiny ISO „M“).
3. Průsečík (buňka) rozsahu průměrů a kódu skupiny ISO je přídavek na obrábění (MA).
4. Průměr předvrtaného otvoru (PHD) dostanete odečtením přídavku na obrábění od průměru pro vystružování.

(Příklad: pro 6mm díru v oceli (P) je PHD 5,85 mm)

		ø DC (mm)															
		1.00	5.00	5.00	8.00	8.00	12.00	12.00	16.00	16.00	30.00	30.00	80.00				
Skup. podle ISO	P	0.10			0.15			0.20			0.20			0.30			0.30
	M	0.08			0.10			0.10			0.20			0.20			0.30
	K	0.10			0.15			0.20			0.20			0.30			0.30
	N	0.10			0.15			0.20			0.20			0.30			0.30
	S	0.05			0.10			0.10			0.15			0.20			0.20
	H	0.05			0.05			0.10			0.10			0.15			0.20

Věnujte pozornost obráběcím tolerancím vrtáků, průměr nástroje není stejný jako vyráběný průměr otvoru!

Pozn.: Doporučený přídavek při použití ručního výstružníku je 0,05 až 0,10 mm.



TABULKA POSUVŮ ZÁHLUBNÍKŮ

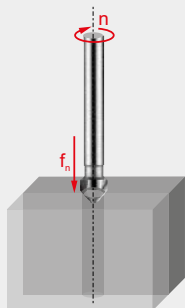

Posuv na otáčku (f_n v mm/ot)
V závislosti na pracovních podmínkách
může být nutné tyto hodnoty upravit
 $\pm 15\%$.

Jak pomocí této tabulky najít posuv na otáčku (f_n):

1. Vyhledejte svůj kód alfa na stránce produktu (například: 23E, „E“ je alfa kód).
2. V horním řádku tabulky najdete nejbližší průměr pro vaši řeznou aplikaci.
3. Vyhledejte svůj alfa kód v levém sloupci tabulky.
4. Průsečík (buňka) průměru a alfa kódu je posuv na otáčku (f_n).

		ø DC (mm)									
		6.00	8.00	10.00	16.00	20.00	25.00	32.00	40.00	60.00	80.00
Posuvy	A	0.030	0.040	0.050	0.060	0.080	0.090	0.100	0.120	0.140	0.160
	B	0.040	0.050	0.060	0.080	0.100	0.120	0.140	0.160	0.180	0.200
	C	0.050	0.060	0.080	0.100	0.120	0.140	0.160	0.180	0.200	0.220
	D	0.060	0.080	0.100	0.120	0.150	0.180	0.200	0.220	0.250	0.280
	E	0.080	0.100	0.120	0.150	0.180	0.200	0.250	0.270	0.300	0.320
	F	0.090	0.110	0.130	0.160	0.190	0.210	0.260	0.290	0.330	0.360
	G	0.100	0.120	0.150	0.180	0.200	0.220	0.280	0.320	0.360	0.400
	H	0.120	0.150	0.180	0.200	0.220	0.250	0.300	0.350	0.400	0.450

Definice výstružníku / názvosloví

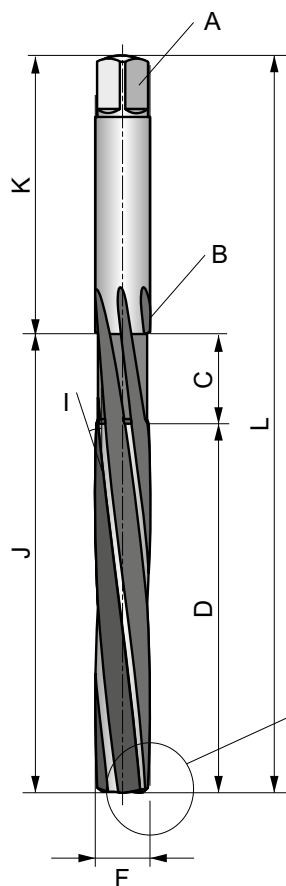

A	Pohon unášečem nebo čtyřhranem
B	Průměr zúžení
C	Délka zúžení
D	Délka řezné části
E	Délka kuželového náběhu
F	Průměr

G	Kuželový náběh
H	Úhel kuželového náběhu
I	Úhel spirály
J	Délka těla
K	Délka stopky
L	Celková délka

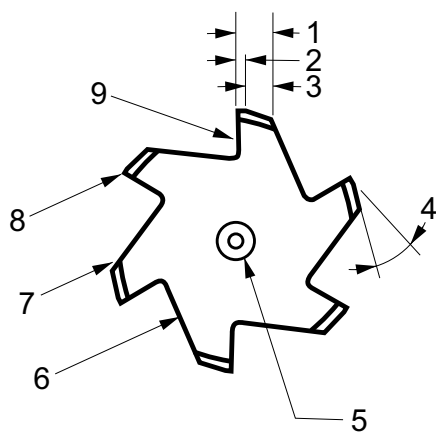
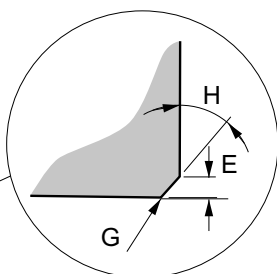

1	Šířka hřbetu
2	Kruhová fazetka
3	Odlehčení
4	Úhel hřbetu
5	Středový otvor
6	Drážka
7	Zadní hrana
8	Řezná hrana
9	Čelo

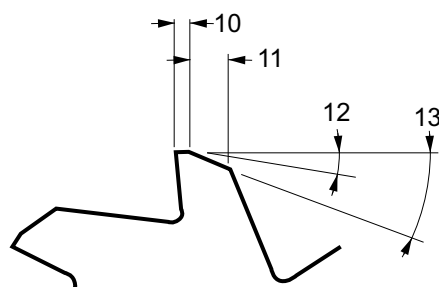

10	Šířka primárního odlehčení
11	Šířka sekundárního odlehčení
12	Primární úhel hřbetu
13	Sekundární úhel hřbetu



VYSTRUŽOVÁNÍ – TECHNICKÉ INFORMACE

Vystružování

Nejlépejších výsledků s výstružníky dosáhnete, když jim umožníte "pracovat". Nejběžnější chybou, ke které dochází před vystružováním, je předvrtat příliš velký otvor. Pokud je v otvoru ponecháno nedostatečné množství materiálu, pak výstružník bude drhnout, bude vykazovat předčasné známky opotřebení a průměr se zmenší. Stejně důležité je neponechat v otvoru příliš velké množství materiálu k obrobení. (Viz obrábění materiálu níže).

1. Zvolte optimální výstružník a optimální rychlost a posuv pro danou operaci. Dbejte na to, aby předvrtané otvory měly správný průměr.
2. Součástka musí být pevně upnuta a vřetenem by nemělo vykazovat žádnou vůli.
3. Sklíčidlo, ve kterém je upnuta stopka výstružníku, musí být kvalitní. Pokud výstružník ve sklíčidle prokluzuje a posuv je automatický, může dojít ke zlomení výstružníku.

4. Omezte vyložení z vřetena stroje na minimum.
5. Použijte doporučenou řeznou kapalinu, která prodlužuje trvanlivost výstružníku, a zajistěte, aby se kapalina dostala k břitům. Vystružování nepatří mezi těžké obrábění, a proto obvykle stačí roztok rozpustného oleje v poměru 1:40. Při vystružování šedé litiny - pokud se obrábí na sucho - lze použít stlačený vzduch.
6. Dbejte na to, aby se drážky výstružníku nezanášely třískami.
7. Před přebroušením výstružníku, zkontrolujte koncentricitu mezi hroty. Ve většině případů je třeba přebrousit pouze úkos náběhu.
8. Dbejte na to, aby výstružníky byly ostré. Časté přebroušování je výhodné, ale je dobré vědět, že výstružník řeže pouze úkosem náběhu, ale ne fazetami. Proto je třeba přebrousovat pouze náběh. Přesnost přebroušování je důležitá pro kvalitu otvoru a pro životnost.

Úběr materiálu

Doporučený úběr materiálu při vystružování závisí na druhu materiálu a kvalitě povrchu předvrtaného otvoru. Obecné instrukce pro úběr materiálu naleznete v následující tabulce:

Velikost vystruženého otvoru (mm)	S předvrtáním	S předvrtáním výhrubníkem
Pod 4	0.1	0.1
Od 4 do 11	0.2	0.15
Od 11 do 39	0.3	0.2
Od 39 do 50	0.4	0.3

Velikost vystruženého otvoru (palce)	S předvrtáním	S předvrtáním výhrubníkem
Pod 3/16"	0.004"	0.004"
Od 3/16v po 1/2"	0.008"	0.006"
Od 1/2v po 1 1/2"	0.010"	0.008"
Od 1 1/2" po 2"	0.016"	0.010"

Ruční/strojní vystružování

I když ruční a strojní výstružníky nabízejí stejné možnosti, pokud jde o velikost dokončeného otvoru, je nutné zvážit použití každého z nich podle daného použití. Ruční výstružník má z důvodu vyrovnání dlouhý kuželový náběh, zatímco strojní výstružník má pouze zkosení 45 stupňů. Strojní výstružník řeže pouze na zkosení, zatímco ruční výstružník řeže na zkosení i na kuželovém náběhu.

VYSTRUŽOVÁNÍ – OMEZENÍ TOLERANCE – TECHNICKÉ INFORMACE

Mezní tolerance

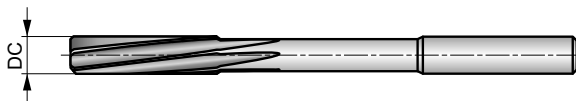

1. Průměry standardních výstružníků

Průměr (DC) se měří na obvodu fazetky hned za kuželovým náběhem. Tolerance jsou podle normy DIN 1420 a je určen k výrobě děr H7.

Tolerance výstružníku			
Průměr (d1)		Mezní tolerance (mm)	
Přes	Do a včetně	Vysoké +	Nízké +
–	3	0.008	0.004
3	6	0.010	0.005
6	10	0.012	0.006
10	18	0.015	0.008

Tolerance výstružníku			
Průměr (d1)		Mezní tolerance (mm)	
Přes	Do a včetně	Vysoké +	Nízké +
18	30	0.017	0.009
30	50	0.021	0.012
50	80	0.025	0.014

2. U otvoru s tolerancí H7

Nejběžnější tolerance dokončeného otvoru odpovídá toleranci H7 (viz tabulka níže). Pro určení ostatních tolerančních polí a jejich šíři použijte následující tabulky.

Tolerance otvoru			
Průměr (d1)		Mezní tolerance (mm)	
Přes	Do a včetně	Vysoké +	Nízké +
–	3	0.010	0
3	6	0.012	0
6	10	0.015	0
10	18	0.018	0

Tolerance otvoru			
Průměr (d1)		Mezní tolerance (mm)	
Přes	Do a včetně	Vysoké +	Nízké +
18	30	0.021	0
30	50	0.025	0
50	80	0.030	0

3. Potřebujete-li najít rozměry speciálního výstružníku, který bude obrábět ve specifických tolerancích např. D8, můžete použít tento osvědčený návod.

Šířka tolerance (mikrony)	Tolerance průměru (μm)							
	nad 1 vč.3	nad 3 vč. 6	nad 6 vč 10	nad 10 vč. 18	nad 18 vč. 30	nad 30 vč. 50	nad 50 vč. 80	nad 80 vč. 120
IT5	4	5	6	8	9	11	13	15
IT6	6	8	9	11	13	16	19	22
IT7	10	12	15	18	21	25	30	35
IT8	14	18	22	27	33	39	46	54
IT9	25	30	36	43	52	62	74	87
IT10	40	48	58	70	84	100	120	140
IT11	60	75	90	110	130	160	190	220
IT12	100	120	150	180	210	250	300	350

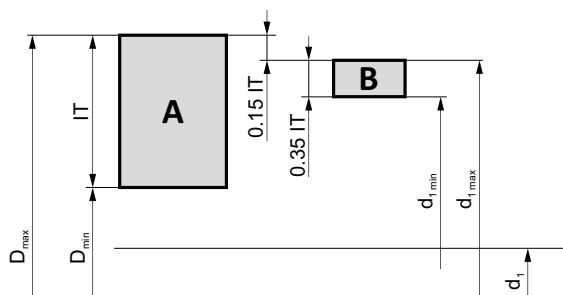

- A = Tolerance otvoru
- B = Tolerance Výstružníku
- IT = Šířka tolerančního pole
- D_{max} = Maximální průměr otvoru
- D_{min} = Minimální průměr otvoru
- d_1 = Nominální průměr
- d_{1max} = Maximální průměr výstružníku
- d_{1min} = Minimální průměr výstružníku

např. otvor o 10 mm s tolerancí D8, max. průměr =10,062, min. průměr = 10,040, tolerance otvoru IT8 = 0,022

Maximální limit: 0,15 x tolerance otvoru (IT8) = 0,0033 zaokrouhleno = 0,004

Minimální limit: 0,35 x tolerance otvoru (IT8) = 0,0077, zaokrouhleno na 0,008

Maximální limit pro výstružník = 10,062 - 0,004 = 10,058

Minimální limit pro výstružník = 10,058 - 0,008 = 10,050

Použití – výběr výstružníku

Nejběžnější typy výstružníků mají levou spirálu, protože hlavní aplikace zahrnují průchozí otvory vyžadující posouvání třísek vpřed. Pro slepé otvory se doporučují výstružníky s rovnými drážkami nebo pravými spirálami.

Nejúčinnější podmínky pro vystružování závisí na použití, materiálu, kvalitě požadovaného otvoru, úběru materiálu, mazání a dalších faktorech. Obecný průvodce povrchovými rychlostmi a posuvy pro

strojní výstružníky je uveden v tabulkách pro WMG a posuv výstružníků (viz katalog nebo Selector) a tabulkách pro úběr materiálu.

Extrémně nerovnoměrné rozteče výstružníků znamenají, že rozdělení není u každého zubu stejné. Protože neexistují žádné dva zuby, které jsou umístěny proti sobě, vytváří výstružník otvor s odchytkou zaoblení mezi 1 a 2 μm . Toto je ve srovnání s rozptylem až 10 μm u konvenčních nerovnoměrných roztečích.

Karbidové výstružníky – porovnávací rozteč / rozteč EU

nerovnoměrné rozteče
chyba kruhovitosti až 10 μm

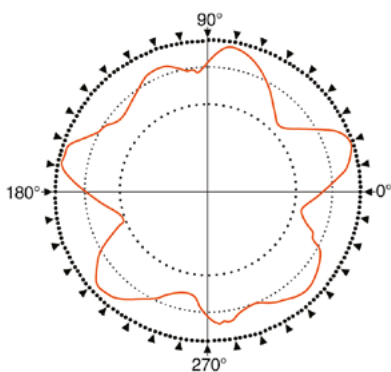

Výsledky kruhovitosti

extrémně nerovnoměrné rozteče
chyba kruhovitosti až 1–2 μm

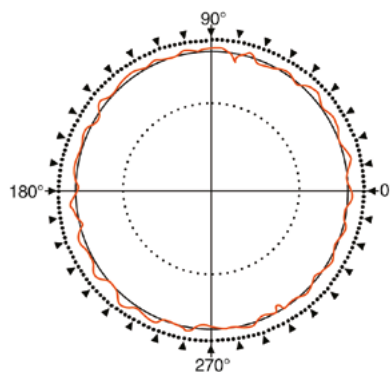

Výsledky kruhovitosti



VYSTRUŽOVÁNÍ – OBECNÉ POZNÁMKY – TECHNICKÉ INFORMACE

Řešení problémů při vystružování

Problém	Příčina	Náprava
Zlomený nebo zkroucený unašeč	Špatné spojení mezi stopkou a nástavcem	Ujistěte se, že stopka i nástavec jsou čisté a nepoškozené.
Rychlé opotřebení nástroje	Nedostatečné množství materiálu k obrábění	Zvětšete objem materiálu k obrobení.
Větší otvor	Rozhození průměru břitů	Přebruste podle správných specifikací.
	Špatné upnutí do vřetena stroje	Opravte a správně nastavte vřeteno.
	Ohyb v nástrojovém držáku	Vyměňte nástrojový držák.
	Stopka nástroje je poškozena	Vyměňte či přebruste stopku.
	Nástroj vykazuje oválnost	Vyměňte nebo přebruste nástroj.
	Asymetrický úhel náběhu	Přebruste podle správných specifikací.
	Příliš velký posuv nebo rychlost	Upravte řezné podmínky podle katalogu.
Menší otvor	Nedostatečné množství materiálu k obrábění	Zvětšete objem materiálu k obrobení.
	Při vystružování vznikají příliš vysoké teploty. Otvor se rozšiřuje a smršťuje	Zvyšte průtok chladiva.
	Průměr nástroje je menší a nástroj opotřebovaný	Přebruste podle správných specifikací.
	Příliš malý posuv a nízká řezná rychlost	Upravte řezné podmínky podle katalogu.
	Předvrtaný otvor je příliš malý	Uberte množství materiálu k obrobení.
Oválné a kuželové otvory	Špatné upnutí do vřetena stroje	Opravte a správně nastavte vřeteno.
	Nesouosost mezi otvorem a nástrojem	Použijte výstružník na nýtové spoje.
	Asymetrický úhel náběhu	Přebruste podle správných specifikací.
Špatná kvalita povrchu otvoru	Příliš mnoho materiálu k obrobení	Uberte množství materiálu k obrobení.
	Opotřebovaný nástroj	Přebruste podle správných specifikací.
	Příliš malý úhel čela	Přebruste podle správných specifikací.
	Příliš řídká emulze nebo řezný olej	Zvyšte koncentraci.
	Posuv a/nebo rychlost příliš nízká	Upravte řezné podmínky podle katalogu.
	Řezná rychlost příliš vysoká	Upravte řezné podmínky podle katalogu.
Nástroj je upnut a zlomí se	Opotřebovaný nástroj	Přebruste podle správných specifikací.
	Zpětný kužel nástroje je příliš malý	Zkontrolujte a vyměňte/upravte nástroj.
	Šířka lůžka je příliš velká	Zkontrolujte a vyměňte/upravte nástroj.
	Materiál součástky se stlačuje	Kompenzujte vychýlení tím, že použijte nastavitelný výstružník.
	Předvrtaný otvor je příliš malý	Uberte množství materiálu k obrobení.
	Heterogenní materiál s tvrdými inkluzemi	Použijte výstružník ze slinutého karbidu.



VŠEOBECNÁ ČÁST – TECHNICKÉ INFORMACE

	Materiál	Tvrdost (HV10)	C %	W %	Mo %	Cr %	V %	Co %	Materiál nástroje
	M2	810 – 850	0.9	6.4	5.0	4.2	1.8	–	HSS
	M35	830 – 870	0.93	6.4	5.0	4.2	1.8	4.8	HSCO
	M42	870 – 960	1.08	1.5	9.4	3.9	1.2	8.0	

Vlastnosti	HSS materiály	Karbidové materiály	K10/30F (často použito pro monolitní nástroje)
Tvrdost (HV30)	800-950	1300 – 1800	1600
Hustota (g/cm ³)	8.0 – 9.0	7.2 – 15	14.45
Pevnost v tlaku (N/mm ²)	3000 – 4000	3000 – 8000	6250
Pevnost v ohybu (N/mm ²)	2500 – 4000	1000 – 4700	4300
Tepelná odolnost (°C)	550	1000	900
E modul (KN/mm ²)	260 – 300	460 – 630	580
Velikost zrna (µm)	–	0.2 – 10	0.8

Kombinace tvrdých částic (WC) a pojivového kovu (Co) poskytuje následující změny charakteristik.

Charakteristika	Vyšší obsah WC poskytuje	Vyšší obsah Co poskytuje
Tvrdost	Vyšší tvrdost	Nižší tvrdost
Pevnost v tlaku (CS)	Vyšší CS	Nižší CS
Pevnost v ohybu (BS)	Nižší BS	Vyšší BS

Vlastnosti materiálu také ovlivňují velikost zrna. Malé velikosti zrna znamenají vyšší tvrdost a hrubá zrna poskytují větší houževnatost.

Příklady povrchových úprav / vlastností povlaků

Povrchové úpravy	Barva	Materiál povlaku	Tvrdost (HV)	Tloušťka (µm)	Struktura povlaku	Koeficient tření oproti oceli	Max. tepl. apl. (°C)
	Zlatá	TiN	2300	1-4	Monovrstva	0.4	600
	Šedo-černá	TiAlN	3300	3	Nanostruktura	0.3-0.35	900



VŠEOBECNÁ ČÁST – TECHNICKÉ INFORMACE

Průmyslové standardní tolerance pro hřídele a otvory

Hodnoty tolerance jsou uvedeny v mikrometrech (µm)

Přepočít pro mikrometry...1 µm = 0,001 mm / 0,000039"

Tolerance	Průměr (mm)							
	> 1 ≤ 3	> 3 ≤ 6	> 6 ≤ 10	> 10 ≤ 18	> 18 ≤ 30	> 30 ≤ 50	> 50 ≤ 80	> 80 ≤ 120
	Průměr (inch)							
	> 0.039" ≤ 0.118"	> 0.118" ≤ 0.236"	> 0.236" ≤ 0.394"	> 0.394" ≤ 0.709"	> 0.709" ≤ 1.181"	> 1.181" ≤ 1.968"	> 1.968" ≤ 3.149"	> 3.149" ≤ 4.724"
Hodnoty tolerance (µm)								
e8	-14 / -28	-20 / -38	-25 / -47	-32 / -59	-40 / -73	-50 / -89	-60 / -106	-72 / -126
f6	-6 / -12	-10 / -18	-13 / -22	-16 / -27	-20 / -33	-25 / -41	-30 / -49	-36 / -58
f7	-6 / -16	-10 / -22	-13 / -28	-16 / -34	-20 / -41	-25 / -50	-30 / -60	-36 / -71
h6	0 / -6	0 / -8	0 / -9	0 / -11	0 / -13	0 / -16	0 / -19	0 / -22
h7	0 / -10	0 / -12	0 / -15	0 / -18	0 / -21	0 / -25	0 / -30	0 / -35
h8	0 / -14	0 / -18	0 / -22	0 / -27	0 / -33	0 / -39	0 / -46	0 / -54
h9	0 / -25	0 / -30	0 / -36	0 / -43	0 / -52	0 / -62	0 / -74	0 / -87
h10	0 / -40	0 / -48	0 / -58	0 / -70	0 / -84	0 / -100	0 / -120	0 / -140
h11	0 / -60	0 / -75	0 / -90	0 / -110	0 / -130	0 / -160	0 / -190	0 / -220
h12	0 / -100	0 / -120	0 / -150	0 / -180	0 / -210	0 / -250	0 / -300	0 / -350
k10	+ 40 / 0	+ 48 / 0	+ 58 / 0	+ 70 / 0	+ 84 / 0	+ 100 / 0	+ 120 / 0	+ 140 / 0
k12	+ 100 / 0	+ 120 / 0	+ 150 / 0	+ 180 / 0	+ 210 / 0	+ 250 / 0	+ 300 / 0	+ 350 / 0
m7	+ 2 / + 12	+ 4 / + 16	+ 6 / + 21	+ 7 / + 25	+ 8 / + 29	+ 9 / + 34	+ 11 / + 41	+ 13 / + 48
js14	+ / -125	+ / -150	+ / -180	+ / -215	+ / -260	+ / -310	+ / -370	+ / -435
js16	+ / -300	+ / -375	+ / -450	+ / -550	+ / -650	+ / -800	+ / -950	+ / -1100
H7	+ 10 / 0	+ 12 / 0	+ 15 / 0	+ 18 / 0	+ 21 / 0	+ 25 / 0	+ 30 / 0	+ 35 / 0
H8	+ 14 / 0	+ 18 / 0	+ 22 / 0	+ 27 / 0	+ 33 / 0	+ 39 / 0	+ 46 / 0	+ 54 / 0
H9	+ 25 / 0	+ 30 / 0	+ 36 / 0	+ 43 / 0	+ 52 / 0	+ 62 / 0	+ 74 / 0	+ 87 / 0
H12	+ 100 / 0	+ 120 / 0	+ 150 / 0	+ 180 / 0	+ 210 / 0	+ 250 / 0	+ 300 / 0	+ 350 / 0
P9	-6 / -31	-12 / -42	-15 / -51	-18 / -61	-22 / -74	-26 / -86	-32 / -106	-37 / -124
S7	-13 / -22	-15 / -27	-17 / -32	-21 / -39	-27 / -48	-34 / -59	-42 / -72	-58 / -93



VŠEOBECNÁ ČÁST – TECHNICKÉ INFORMACE

Tabulka řezných rychlostí

		Vc															
m/min		5	8	10	15	20	25	30	40	50	60	70	80	90	100	110	150
SFM (feet/min.)		16	26	32	50	66	82	98	130	165	197	230	262	296	330	362	495
Ø		ot/min															
mm	inch																
1.00	–	1592	2546	3183	4775	6366	7958	9549	12732	15916	19099	22282	25465	28648	31831	35014	47747
1.50	–	1061	1698	2122	3183	4244	5305	6366	8488	10610	12732	14854	16977	19099	21221	23343	31831
2.00	–	796	1273	1592	2387	3183	3979	4775	6366	7958	9549	11141	12732	14324	15916	17507	23873
2.50	–	637	1019	1273	1910	2546	3183	3820	5093	6366	7639	8913	10186	11459	12732	14006	19099
3.00	–	531	849	1061	1592	2122	2653	3183	4244	5305	6366	7427	8488	9549	10610	11671	15916
3.18	1/8	500	801	1001	1501	2002	2502	3003	4004	5005	6006	7007	8008	9009	10010	11011	15015
3.50	–	455	728	909	1364	1819	2274	2728	3638	4547	5457	6366	7276	8185	9095	10004	13642
4.00	–	398	637	796	1194	1592	1989	2387	3183	3979	4775	5570	6366	7162	7958	8754	11937
4.50	–	354	566	707	1061	1415	1768	2122	2829	3537	4244	4951	5659	6366	7074	7781	10610
4.76	3/16	334	535	669	1003	1337	1672	2006	2675	3344	4012	4681	5350	6018	6687	7356	10031
5.00	–	318	509	637	955	1273	1592	1910	2546	3183	3820	4456	5093	5730	6366	7003	9549
6.00	–	265	424	531	796	1061	1326	1592	2122	2653	3183	3714	4244	4775	5305	5836	7958
6.35	1/4	251	401	501	752	1003	1253	1504	2005	2506	3008	3509	4010	4511	5013	5514	7519
7.00	–	227	364	455	682	909	1137	1364	1819	2274	2728	3183	3638	4093	4547	5002	6821
7.94	5/16	200	321	401	601	802	1002	1203	1604	2004	2405	2806	3207	3608	4009	4410	6013
8.00	–	199	318	398	597	796	995	1194	1592	1989	2387	2785	3183	3581	3979	4377	5968
9.00	–	177	283	354	531	707	884	1061	1415	1768	2122	2476	2829	3183	3537	3890	5305
9.53	3/8	167	267	334	501	668	835	1002	1336	1670	2004	2338	2672	3006	3340	3674	5010
10.00	–	159	255	318	477	637	796	955	1273	1592	1910	2228	2546	2865	3183	3501	4775
11.11	7/16	143	229	287	430	573	716	860	1146	1433	1719	2006	2292	2579	2865	3152	4298
12.00	–	133	212	265	398	531	663	796	1061	1326	1592	1857	2122	2387	2653	2918	3979
12.70	1/2	125	201	251	376	501	627	752	1003	1253	1504	1754	2005	2256	2506	2757	3760
14.00	–	114	182	227	341	455	568	682	909	1137	1364	1592	1819	2046	2274	2501	3410
14.29	9/16	111	178	223	334	446	557	668	891	1114	1337	1559	1782	2005	2228	2450	3341
15.00	–	106	170	212	318	424	531	637	849	1061	1273	1485	1698	1910	2122	2334	3183
15.88	5/8	100	160	200	301	401	501	601	802	1002	1203	1403	1604	1804	2004	2205	3007
16.00	–	99	159	199	298	398	497	597	796	995	1194	1393	1592	1790	1989	2188	2984
17.46	11/16	91	146	182	273	365	456	547	729	912	1094	1276	1458	1641	1823	2005	2735
18.00	–	88	141	177	265	354	442	531	707	884	1061	1238	1415	1592	1768	1945	2653
19.05	3/4	84	134	167	251	334	418	501	668	835	1003	1170	1337	1504	1671	1838	2506
20.00	–	80	127	159	239	318	398	477	637	796	955	1114	1273	1432	1592	1751	2387
24.00	–	66	106	133	199	265	332	398	531	663	796	928	1061	1194	1326	1459	1989
25.00	–	64	102	127	191	255	318	382	509	637	764	891	1019	1146	1273	1401	1910
27.00	–	59	94	118	177	236	295	354	472	589	707	825	943	1061	1179	1297	1768
30.00	–	53	85	106	159	212	265	318	424	531	637	743	849	955	1061	1167	1592
32.00	–	50	80	99	149	199	249	298	398	497	597	696	796	895	995	1094	1492
36.00	–	44	71	88	133	177	221	265	354	442	531	619	707	796	884	973	1326
40.00	–	40	64	80	119	159	199	239	318	398	477	557	637	716	796	875	1194
50.00	–	32	51	64	95	127	159	191	255	318	382	446	509	573	637	700	955



VŠEOBECNÁ ČÁST – TECHNICKÉ INFORMACE

Tvrdość a pevnost v tahu

HV	HRC	HB	Pevnost v tahu	
			N/mm ²	Tons /sq. in.
Vickers	Rockwell	Brinell		
940	68	–	–	–
900	67	–	–	–
864	66	–	–	–
829	65	–	–	–
800	64	–	–	–
773	63	–	–	–
745	62	–	–	–
720	61	–	–	–
698	60	–	–	–
675	59	–	–	–
655	58	–	2200	142
650	–	618	2180	141
640	–	608	2145	139
639	57	607	2140	138
630	–	599	2105	136
620	–	589	2070	134
615	56	584	2050	133
610	–	580	2030	131
600	–	570	1995	129
596	55	567	1980	128
590	–	561	1955	126
580	–	551	1920	124
578	54	549	1910	124
570	–	542	1880	122
560	53	532	1845	119
550	–	523	1810	117
544	52	517	1790	116
540	–	513	1775	115
530	–	504	1740	113
527	51	501	1730	112
520	–	494	1700	110
514	50	488	1680	109
510	–	485	1665	108
500	–	475	1630	105
497	49	472	1620	105
490	–	466	1595	103
484	48	460	1570	102
480	–	456	1555	101
473	47	449	1530	99
470	–	447	1520	98
460	–	437	1485	96
458	46	435	1480	96
450	–	428	1455	94
446	45	424	1440	93
440	–	418	1420	92

HV	HRC	HB	Pevnost v tahu	
			N/mm ²	Tons /sq. in.
Vickers	Rockwell	Brinell		
434	44	413	1400	91
423	43	402	1360	88
413	42	393	1330	86
403	41	383	1300	84
392	40	372	1260	82
382	39	363	1230	80
373	38	354	1200	78
364	37	346	1170	76
355	36	337	1140	74
350	–	333	1125	73
345	35	328	1110	72
340	–	323	1095	71
336	34	319	1080	70
330	–	314	1060	69
327	33	311	1050	68
320	–	304	1030	67
317	32	301	1020	66
310	31	295	995	64
302	30	287	970	63
300	–	285	965	62
295	–	280	950	61
293	29	278	940	61
290	–	276	930	60
287	28	273	920	60
285	–	271	915	59
280	27	266	900	58
275	–	261	880	57
272	26	258	870	56
270	–	257	865	56
268	25	255	860	56
265	–	252	850	55
260	24	247	835	54
255	23	242	820	53
250	22	238	800	52
245	–	233	785	51
243	21	231	780	50
240	–	228	770	50
235	–	223	755	49
230	–	219	740	48
225	–	214	720	47
220	–	209	705	46
215	–	204	690	45
210	–	199	675	44
205	–	195	660	43
200	–	190	640	41



**VRTÁKY HYDRA
DESTIČKOVÉ VRTÁKY**





VÝROBA OTVORŮ – OBSAH

6		WMG A ISO 13399
12	MONOLITNÍ VRTÁKY	NÁVOD
15		MONOLITNÍ KARBIDOVÉ VRTÁKY
66		HSS VRTÁKY
176		ŘEZNÉ KAPALINY
186		TECHNICKÉ INFORMACE
190		VÝSTRUŽNÍKY A ZÁHLUBNÍKY
264	DESTIČKOVÉ VRTÁKY	NÁVOD
271		VRTÁKY HYDRA
297		TECHNICKÉ INFORMACE
307		DESTIČKOVÉ VRTÁKY
327		TECHNICKÉ INFORMACE
350	VYVRTÁVACÍ SYSTÉMY	NÁVOD
359		VYVRTÁVACÍ HLAVY
376		PŘÍSLUŠENSTVÍ PRO VYVRTÁVÁNÍ
381		BŘITOVÉ DESTIČKY
404		UPÍNACÍ TRNY
418		VYVRTÁVACÍ SADY
429		TECHNICKÉ INFORMACE



BŘITOVÉ DESTIČKY – PŘEHLED STRÁNKY



1

SCET

	IC	D1	L	S
	[mm]	[mm]	[mm]	[mm]
0502	5.556	2.40	5.56	2.38
0602	6.350	2.90	6.35	2.38
0703	7.937	3.50	7.94	3.18
09T3	9.525	4.50	9.53	3.97
1204	12.700	5.60	12.70	4.76
1505	15.875	5.60	15.88	5.56

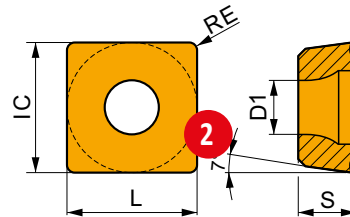

Vhodné startovací podmínky pro řeznou rychlost (Vc), posuv (f) a hloubka řezu (Ap). Další výpočty naleznete v naší aplikaci Kalkulátor řezných podmínek.

Product	RE (mm)	P			M			K			N			S			H		
		vc	f	ap	vc	f	ap	vc	f	ap	vc	f	ap	vc	f	ap			
		[m/min]	[mm/rev]	[mm]	[m/min]	[mm/rev]	[mm]	[m/min]	[mm/rev]	[mm]	[m/min]	[mm/rev]	[mm]	[m/min]	[mm/rev]	[mm]	[m/min]	[mm/rev]	[mm]

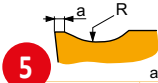

SD utvařeč s univerzální geometrií pro vnější destičky.

SCET 050204-UD	0,12
SCET 060204-UD	0,15
SCET 070308-UD	0,15
SCET 09T308-UD	0,15
SCET 120408-UD	0,20
SCET 150512-UD	0,20

10

SCET 050204-UD	D8330	0.4	165	0.08	-	-	-	-	155	0.08	-	-	-	-	-	-	-	-	-
	D9335	0.4	240	0.08	-	-	-	-	225	0.08	-	-	-	-	-	-	-	-	-
SCET 060204-UD	D8330	0.4	165	0.11	-	-	-	-	155	0.11	-	-	-	-	-	-	-	-	-
	D9335	0.4	240	0.11	-	-	-	-	225	0.11	-	-	-	-	-	-	-	-	-
SCET 070308-UD	D8330	0.8	165	0.13	-	-	-	-	155	0.13	-	-	-	-	-	-	-	-	-
	D9335	0.8	240	0.13	-	-	-	-	225	0.13	-	-	-	-	-	-	-	-	-
SCET 09T308-UD	D8330	0.8	165	0.14	-	-	-	-	155	0.14	-	-	-	-	-	-	-	-	-
	D9335	0.8	240	0.14	-	-	-	-	225	0.14	-	-	-	-	-	-	-	-	-
SCET 120408-UD	D8330	0.8	165	0.16	-	-	-	-	155	0.16	-	-	-	-	-	-	-	-	-
	D9335	0.8	240	0.16	-	-	-	-	225	0.16	-	-	-	-	-	-	-	-	-
SCET 150512-UD	D8330	1.2	165	0.18	-	-	-	-	155	0.18	-	-	-	-	-	-	-	-	-
	D9335	1.2	240	0.18	-	-	-	-	225	0.18	-	-	-	-	-	-	-	-	-

11

SCET120408-UD:D9335

Při objednávce použijte celý kód specifikace destičky!

Materiál

Zahrňte dvojtečku

Kód břitové destičky
ISO



BŘITOVÉ DESTIČKY – PŘEHLED STRÁNKY

Poz.	Popis	Poz.	Popis
1	Označení destičky	7	Kód břitové destičky ISO
2	Schematické vyobrazení destičky	8	Materiál
3	Tabulka s velikostmi destiček (mm)	9	Rádus destičky (mm)
4	Obrázek znázornění destičky	10	Popis geometrie
5	Profil hlavní řezné hrany	11	Aplikační oblast destičky
6	Ikony – konkrétní vlastnosti a typ řezné hrany		



DESTIČKOVÉ VRTÁKY – PŘEHLED STRÁNKY

1

802D



PRAMET

3

S



5

2xD 802D Vrták s destičkami a vnitřním chlazením

Vysoce výkonný vrták s destičkami pro vrtání slepých a průchozích otvorů. Také může být potenciálně použit pro křížení otvorů, vrtání mimo osu, spirálovou interpolaci, zajištění pod úhlem, vrtání do vypouklých a šikmých ploch, vrtání v přerušovaném řezu, srážení úkosů a vyvrtávání. Dostupný v Ø15 - Ø40 mm a délce 2xD.

4

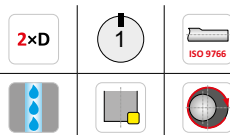
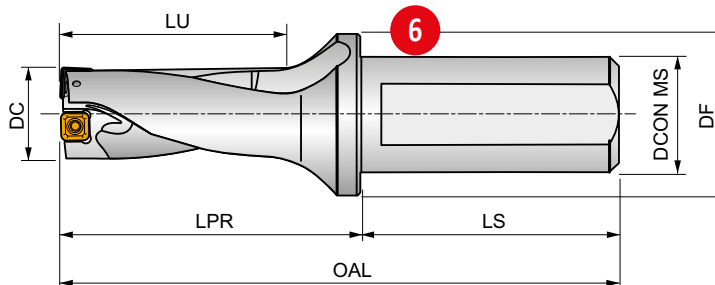

7



8

Product	DC	APMX	OAL	LPR	LS	LU	DCON MS	DF	\bar{D}	D^+					
	[mm]	[mm]	[mm]	[mm]	[mm]	[mm]	[mm]	[mm]	[mm]	[mm]					
802D-15-30-S25	15	30.00	121	65	56	34.5	25	35	0.25	0.35	EP253253	GI300	GI313	0.30	HM001
802D-16-32-S25	16	32.00	123	67	56	37	25	35	0.45	0.45	EP253253	GI300	GI313	0.30	HM001
802D-17-34-S25	17	34.00	125	69	56	39.5	25	35	0.50	0.50	EP253253	GI301	GI314	0.31	HM002
802D-18-36-S25	18	36.00	127	71	56	42	25	35	0.35	0.25	EP253253	GI301	GI314	0.31	HM002
802D-19-38-S25	19	38.00	129	73	56	44.5	25	35	0.15	0.45	EP253253	GI301	GI314	0.32	HM002

9

10

11

12

13

14

15

16

GI300	XPET 0502AP	SCET 050204-UD
GI301	XPET 0602AP	SCET 050204-UD
GI302	XPET 0602AP	SCET 060204-UD
GI303	XPET 0703AP	SCET 060204-UD
GI304	XPET 0703AP	SCET 070308-UD
GI305	XPET 0903AP	SCET 070308-UD
GI306	XPET 0903AP	SCET 09T308-UD
GI307	XPET 11T3AP	SCET 09T308-UD
GI308	XPET 11T3AP	SCET 120408-UD
GI309	XPET 12T3AP	SCET 120408-UD
GI313	XPET 0502AP-SD	SCET 050204-SD
GI314	XPET 0602AP-SD	SCET 050204-SD
GI315	XPET 0602AP-SD	SCET 060204-SD
GI316	XPET 0703AP-SD	SCET 060204-SD
GI317	XPET 0703AP-SD	SCET 070308-SD
GI318	XPET 0903AP-SD	SCET 070308-SD
GI319	XPET 0903AP-SD	SCET 09T308-SD
GI320	XPET 11T3AP-SD	SCET 09T308-SD
GI321	XPET 11T3AP-SD	SCET 120408-SD
GI322	XPET 12T3AP-SD	SCET 120408-SD

17

18

GI300	XPET 0502AP	SCET 050204-UD
GI301	XPET 0602AP	SCET 050204-UD
GI302	XPET 0602AP	SCET 060204-UD
GI303	XPET 0703AP	SCET 060204-UD

19



DESTIČKOVÉ VRTÁKY – PŘEHLED STRÁNKY

Poz.	Popis	Poz.	Popis
1	Označení vrtáku	11	Radiální nastavení (mm)
2	Doporučení skupin materiálů	12	Nastavitelná objímka
3	Upínací systém destičky	13	Skupina kompatibilních destiček s utvářečem UD ^{1), 2)}
4	Popis nástroje	14	Skupina kompatibilních destiček s utvářečem SD ^{1), 2)}
5	Zobrazení produktu	15	Hmotnost (kg)
6	Schematické vyobrazení nástroje	16	Skupina náhradních dílů ¹⁾
7	Parametry produktu	17	Kompatibilní destičky s utvářečem UD
8	Aplikace produktu	18	Kompatibilní destičky s utvářečem SD
9	Kód nástroje	19	Náhradní díly
10	Rozměry nástroje		

¹⁾ Kód skupiny kompatibilních destiček a náhradních dílů se používá pouze pro účely tohoto katalogu. Nelze jej použít pro objednávky.

²⁾ Vnější (SCET) a vnitřní (XPET) destičky musí mít vždy stejný utvářeč (Pozor: UD utvářeč není viditelně zahrnut v označení destiček XPET – např. XPET 0502AP.); informace potřebné pro správnou volbu utvářeče (UD versus SD) najdete na obalu destičky.



1

H851

DORMER



Těleso vrtáku HYDRA 1.5xD s vnitřním chlazením, Povrchová úprava lesklé niklování

Použití pro upnutí hlav HYDRA R950, R960 a R970. Několik velikostí hlav může být upínáno do téhož tělesa vrtáku. Vnitřní chlazení pro zlepšení chladicího efektu. Povrchová úprava lesklým niklováním brání korozi a zlepšuje odvod třísek.

2

HYDRA

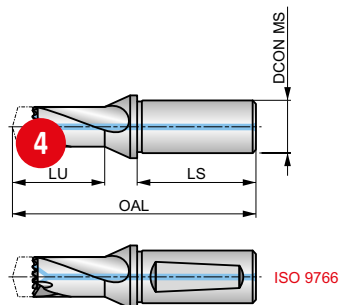

HSS	DORMER	1.5xD
Bright Ni	ISO 9766	R

5

Součásti balení jsou 4 ks šroubků a 1 ks šroubovaku, DCON MS v toleranci h6.

Product	DCONMS	DCON MS	LU	OAL	LS	ADINTMS
	[inch]	[mm]	[mm]	[mm]	[mm]	
H85131/64	5/8	15.88	25.50	88.5	47.6	Cylindrical
H8511/2	5/8	15.88	25.80	88.8	47.6	Cylindrical
H85117/32	5/8	15.88	30.90	93.9	47.6	Cylindrical
H85112.0	–	16.00	25.50	88.5	48.0	ISO 9766
H85112.5	–	16.00	25.80	88.8	48.0	ISO 9766
H85113.0	–	16.00	27.00	90.0	48.0	ISO 9766
H85114.0	–	16.00	30.90	93.9	48.0	ISO 9766
H8519/16	3/4	19.05	30.30	93.9	50.8	Cylindrical
H85139/64	3/4	19.05	32.30	97.3	50.8	Cylindrical
H85111/16	3/4	19.05	39.00	101.4	50.8	Cylindrical
H85123/32	3/4	19.05	39.00	104.0	50.8	Cylindrical
H85115.0	–	20.00	32.30	97.3	50.0	ISO 9766
H85116.0	–	20.00	34.90	99.9	50.0	ISO 9766
H85117.0	–	20.00	36.40	101.4	50.0	ISO 9766
H85118.0	–	20.00	39.00	104.0	50.0	ISO 9766
H85119.0	–	25.00	40.40	111.4	56.0	ISO 9766
H85120.0	–	25.00	43.00	114.0	56.0	ISO 9766
H85121.0	–	25.00	44.50	115.5	56.0	ISO 9766

6

7

Poz.	Popis
1	Označení vrtáku
2	Popis produktu
3	Zobrazení produktu
4	Schematické vyobrazení nástroje

Poz.	Popis
5	Parametry produktu
6	Kód produktu
7	Rozměry produktu



VÝMĚNNÁ HLAVA A DESTIČKOVÉ VRTÁKY – PŘEHLED IKON

OBECNÉ IKONY



Hlavní použití



Podmíněné použití



Špička vrtáku 140°

SKUPINA ZÁKLADNÍCH NOREM (BSG)



Normy Dormer

OZNAČENÍ UPÍNÁNÍ



Upínání šroubkem typu S

POVLAK



Lesklé niklování



Speciální povlak TiAlN (+ silikon + chrom)

VLASTNOST DODÁVKY CHLADICÍ KAPALINY (CSP)



Vnitřní chlazení

TŘÍDA TOLERANČNÍHO POLE ŘEZNÉHO PRŮMĚRU (TCDC)



h7 – Toleranční pole nástrojů pro průmyslovou normu (na základě rozsahu průměrů)

SMĚR ŘEZU



Pravostranné otáčení / řez

OBECNÉ VLASTNOSTI NÁSTROJŮ



1 efektivní zub na otáčku



Monoblokové provedení



Možnost použití pro excentrické obrábění



Univerzální stopka

ŘEZNÁ HRANA DESTIČKY



Zaoblená hrana s fazetkou

VLASTNOSTI DESTIČKY



Pro houževnaté obráběné materiály (dlouhá tříška)



Obtížné pracovní podmínky



Univerzální možnost širokého rozsahu

KÓD MATERIÁLU (BMC)



Tvrký materiál (monolitní karbid)



Materiál nástroje HSS

VRTACÍ OPERACE



Vyvrtávání slepého otvoru



Vrtání slepého otvoru



Vyvrtávání



Vyvrtávání přes příčné otvory



Vyvrtávání do rohu



Výstup vrtáku na šikmém povrchu



Vrtání přes stávající otvor



Vrtání skládaných materiálů



Vrtání na zakřiveném povrchu



Vrtání na šikmém povrchu



Spirálové interpolační vyvrtávání



Spirálové interpolační vrtání



Srážení hran (zkosení)



Přerušovaný řez



Vyvrtávání průchozích otvorů



Vrtání průchozích otvorů



Vrtání svařovaných spojů



VRTÁKY HYDRA A DESTIČKOVÉ VRTÁKY – PŘEHLED IKON

OSTATNÍ IKONY



Upínací moment šroubku (Nm)

STOPKA



Válcová stopka s přírubou



Válcové stopky ISO 9766 (s ploškou nebo bez ní)



Stopka DIN 6535 – HB (Weldon) nebo HE (pišťalová drážka)

TECHNICKÉ STRÁNKY



Posuv (mm/ot)



Vyšší řezná rychlost, mírně snížená tuhost soustavy (kolísavá hloubka řezu)



Nížší řezná rychlost, nízká tuhost soustavy (přerušovaný řez)



Velmi vysoká řezná rychlost, excelentní tuhost soustavy (stabilní záběrové podmínky)



Střední řezná rychlost, snížená tuhost soustavy (mírně přerušovaný řez)



Nízká řezná rychlost, velmi nízká tuhost soustavy (velmi špatné záběrové podmínky)



Vysoká řezná rychlost, dobrá tuhost soustavy (stabilní záběrové podmínky)

POMĚR POUŽITELNÉ DÉLKY A PRŮMĚRU (ULDR)

1.5xD

Poměr použitelné hloubky nástroje k průměru $1,5 \times D$

5xD

Poměr použitelné hloubky nástroje k průměru $5 \times D$

2xD

Poměr použitelné hloubky nástroje k průměru $2 \times D$

12xD

Poměr použitelné hloubky nástroje k průměru $12 \times D$

8xD

Poměr použitelné hloubky nástroje k průměru $8 \times D$

4xD

Poměr použitelné hloubky nástroje k průměru $4 \times D$

3xD

Poměr použitelné hloubky nástroje k průměru $3 \times D$



VRTÁKY HYDRA



HYDRA

VYSOCE VÝKONNÉ VÝMĚNNÉ VRTACÍ HLAVY

Stávající řadu vrtáků Hydra jsme doplnili o nové délky těl. Délka 12×D pro vrtání hlubokých otvorů a tělo délky 1,5×D pro vyšší tuhost vrtání mělkých otvorů desek a silných plechů.

Těla vrtáků umožňují upnout celou škálu hlav z monolitního karbidu pro obrábění oceli, korozivzdorné oceli a litiny.

VLASTNOSTI A VÝHODY

- **Stabilní vysoký výkon**, i po několika výměnách hlavy.
- **Snížení nákladů** – jedno tělo vrtáku umožňuje upnout několik velikostí karbidových hlav.
- **Univerzálnost** – válcová stopka s plochou umožňující vícenásobné upnutí nástroje.
- **Snadné a rychlé výměny hlavy** s minimálním přerušením výrobního procesu. Hlavy lze vyměnit bez vysunutí těla vrtáku ze stroje.
- Přesné dosednutí hlavy na tělo maximalizuje tuhost, což umožňuje dosáhnout **špičkové přesnosti otvorů** a přesných tolerancí.

MATERIÁL

HLAVA Z PRÉMIOVÉHO MIKROZRNNÉHO KARBIDU

- Mikrozrnny karbid nabízí skvělou kombinaci tvrdosti a houževnatosti, což má za následek vysokou odolnost proti opotřebení a delší životnost nástrojů.

TĚLO VRTÁKU Z TVRZENÉ OCELI

- Tvrzená ocel s vysoce lesklým niklováním pro vysokou odolnost proti opotřebení a korozi.

POVLAKOVÁNÍ

POVLAK NA BÁZI TITAN ALUMINIUM NITRIDU (TiAlN) ZAJIŠŤUJE:

- Vysokou houževnatost a odolnost proti oxidaci.
- Výjimečnou ochranu při obrábění abrazivních materiálů například litiny.
- Vysokou tvrdost při vysokých teplotách vznikajících při vrtání do litiny.
- Prodlouženou životnost a produktivitu nástroje.

TYPY HLAV



R950

OCEL



R960

KOROZIVZDORNÁ
OCEL



R970

LITINA

GEOMETRIE

KONSTRUKCE ROHŮ

- Silnější konstrukce rohů zvyšuje stabilitu při vrtání a snižuje síly při výstupu z materiálu.
- Díky tomu lze dosáhnout vyšší kvality koncového povrchu a předchází se vzniku otřepů, k němuž může dojít při vrtání do materiálů se zrnitou mikrostrukturou.

GEOMETRIE HROTU

- 140° geometrie špičky usnadňuje vystředování a snižuje přitlačnou sílu při vrtání do většiny materiálů.

KOMPLETNÍ ŘADA

- Dostupné v délkách 1,5×D, 3×D, 5×D, 8×D a 12×D s otvory pro přívod chladicí kapaliny, která zvyšuje účinnost v řezu a zlepšuje odvod třísek, čímž se zvyšuje produktivita.
- Metrické: 12,00 mm až 42,00 mm.
- Palcové: 15/32 in až 1.5/8 in.
- Nejlepších výsledků lze dosáhnout s použitím hydraulických upínacích pouzder. Upínat lze také do držáků typu ER a Weldon.



DÉLKY TĚL

1.5×D



3×D



5×D



8×D



12×D





VRTÁKY HYDRA – NAVIGÁTOR PRO MATERIÁL NÁSTROJE



Materiály nástroje

Rychlořezná ocel		Středně legovaná rychlořezná ocel, která má dobrou obrobiteľnosť a dobrý výkon. HSS vykazuje vlastnosti, jako je tvrdost, houževnatost a odolnost vůči opotřebení, díky nimž je atraktivní v široké škále aplikací například u vrtáků a závitníků.
-------------------------	---	--

Karbidové materiály

Karbidové materiály (nebo tvrdé materiály)		<p>Substrát vyrobený slinovaním pomocí práškové metalurgie sestávající z kompozitu kovového karbidu s pojivovým kovem. Nejvýznamnější surovinou je wolfram-karbid (WC). Wolfram-karbid přispívá k tvrdosti materiálu. Karbid tantalu (TaC), karbid titanu (TiC) a karbid niobu (NbC) doplňují WC a upravují vlastnosti podle požadavku. Tyto tři materiály se nazývají kubické karbidy. Kobalt (Co) působí jako pojivo a udržuje materiál pohromadě.</p> <p>Karbidové materiály se často vyznačují vysokou pevností v tlaku, vysokou tvrdostí, a tedy vysokou odolností vůči opotřebení, ale také omezenou pevností v ohybu a houževnatostí. Karbid se používá u závitníků, výstružníků, fréz, vrtáků a závitových fréz.</p>
---	---	--

Povrchové povlaky

Lesklé niklování		Leskle niklovaný povrch chrání tělo z kalené oceli před rzi, korozi a také zlepšuje odvod třísek.
Ti-phon (TiAlCrSiN)		Ti-phon je povlak podobný TiAlN, avšak s přidáním chromu (Cr) a křemíku (Si), který je speciálně vyvinut pro vrtáky Hydra, aby se zabránilo tvorbě nárůstku a výrazně zlepšil tok třísek. Tento povlak vykazuje vysokou tvrdost za tepla, vysokou odolnost proti oxidaci a vynikající mazivost při použití u nástrojů pro obráběcí aplikace zahrnující velkou mechanickou a tepelná napětí, vysoké řezné rychlosti a vysoké rychlosti posuvu. Tyto vlastnosti povlaku se promítají do vynikající odolnosti vůči opotřebení a pevnosti hran.



DORMER PRAMET



VŠECHNY NÁSTROJE NA JEDNOM MÍSTĚ

Celý sortiment monolitních nástrojů a vyměnitelných břitových destiček najdete v mobilní aplikaci Kalkulačka řezných podmínek. Obsahuje více než 40 000 položek! S touto aplikací bude Vaše obrábění snadnější. **Jednoduše spolehliví.**

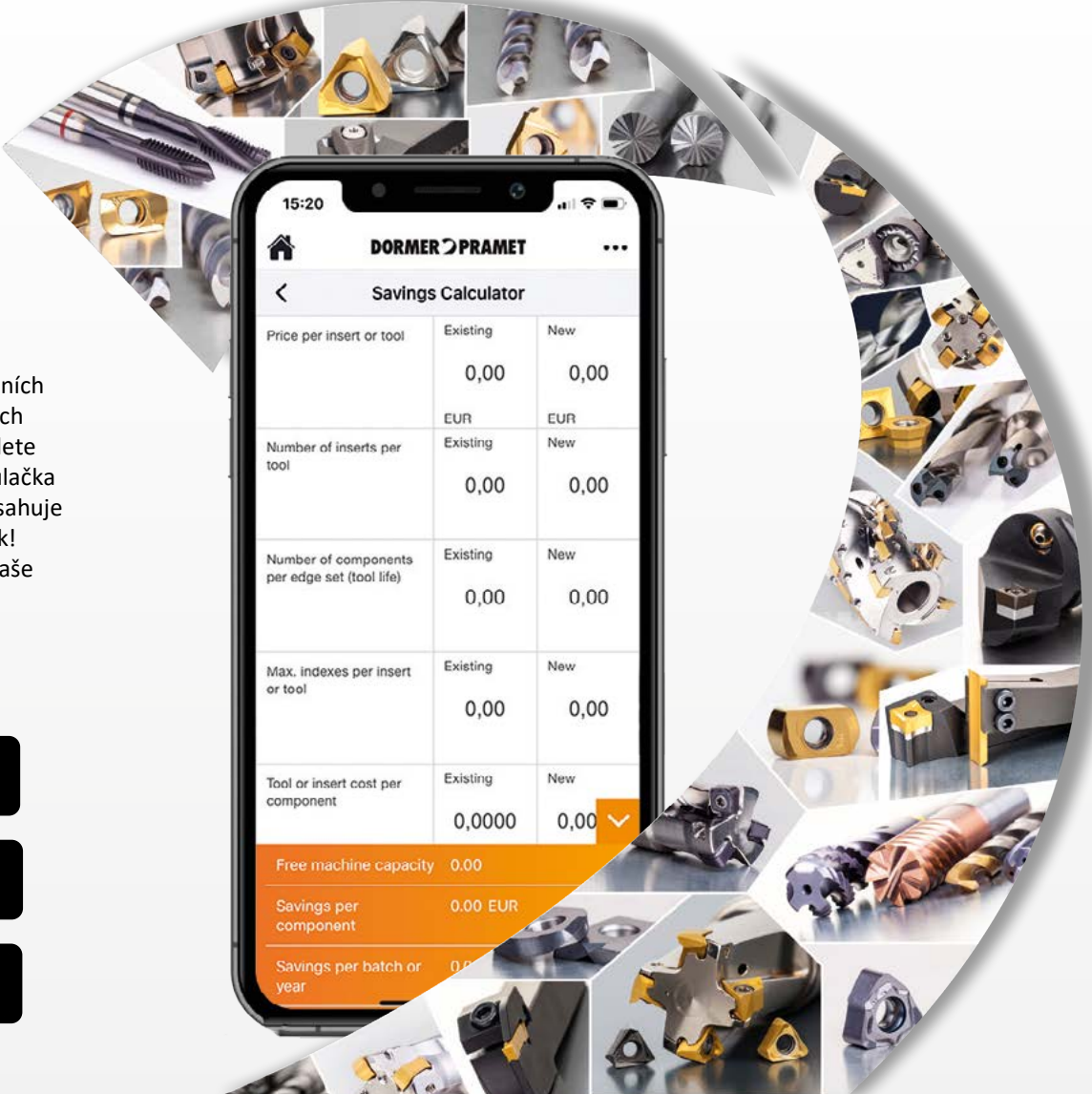
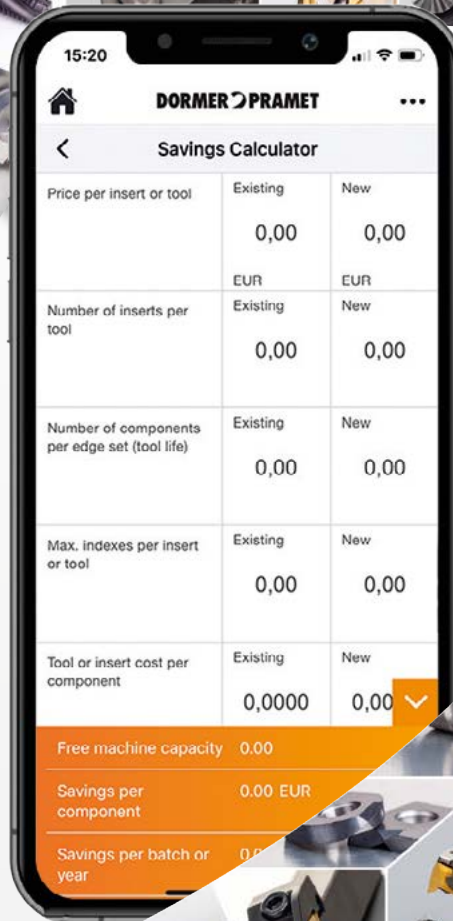



Materiál nástroje (BMC)	HM	HM	HM	HSS	HSS	HSS	HSS	HSS					
Norma (BSG)	DORMER	DORMER	DORMER	DORMER	DORMER	DORMER	DORMER	DORMER					
Hĺoubka vrtání (ULDR)				1.5xD	3xD	5xD	8xD	12xD					
Úhel vrcholu	140°	140°	140°										
Povlak	Ti-phon	Ti-phon	Ti-phon	Bright Ni	Bright Ni	Bright Ni	Bright Ni	Bright Ni					
Stopka				ISO 9766	DIN 6535HB DIN 6535HE	DIN 6535HB DIN 6535HE	DIN 6535HB DIN 6535HE	DIN 6535HB DIN 6535HE					
Směr chodu (otáček)	R	R	R	R	R	R	R	R					
Chlazení (CSP)													
Kód produktové řady	R950	R960	R970	H851	H853	H855	H858	H8512	H860	H861			
	12.00 - 42.00, 15/32 - 1.5/8	12.00 - 30.50, 15/32 - 1.3/16	12.00 - 42.00, 15/32 - 1.5/8	12.00 - 30.50, 15/32 - 1.3/16	12.00 - 42.50, 15/32 - 1.5/8	12.00 - 42.50, 15/32 - 1.5/8	13.50 - 42.50, 35/64 - 1.5/8	13.50 - 25.65, 35/64 - 1.1/64	N1 - N7	N1 - N6			
	281	283	285	287	289	291	293	294	295	296			
P	P1	■	■										
	P2	■	■										
	P3	■											
	P4	■											
M	M1		■										
	M2		■										
	M3		■										
	M4		■										
K	K1		■	■									
	K2	■	■	■									
	K3	■	■	■									
	K4	■	■	■									
	K5	■	■	■									
N	N1												
	N2												
	N3												
	N4												
	N5												
S	S1		■										
	S2		■										
	S3		■										
	S4		■										
H	H1												
	H2												
	H3												
	H4												

■ Hlavní použití ■ Podmíněné použití



VYSOCE VÝKONNÉ VÝMĚNNÉ VRTÁKOVÉ HLAVY

Uspořádání										
	DC	H851 1.5xD	H853 3xD	H855 5xD	H858 8xD	H8512 12xD	R950	R960	R970	H860
Rozsah	12.00 – 30.50 15/32" – 1.3/16"	12.00 – 42.50 15/32" – 1.5/8"	12.00 – 42.50 15/32" – 1.5/8"	13.50 – 42.50 35/64" – 1.5/8"	13.50 – 25.65 35/64" – 1.1/64"	12.00 – 42.00 15/32" – 1.5/8"	12.00 – 30.50 15/32" – 1.3/16"	12.00 – 42.00 15/32" – 1.5/8"	N1 – N7	N1 – N6
Stránky	287	289	291	293	294	281	283	285	295	296

DC	H851 1.5xD	H853 3xD	H855 5xD	H858 8xD	H8512 12xD	R950	R960	R970	H860	H861
15/32"						R95015/32	R96015/32	R97015/32		
12.0						R95012.0	R96012.0	R97012.0		
12.1	H85112.0	H85312.0	H85512.0	–	–	R95012.1	R96012.1	R97012.1		
12.2	H85131/64	H85331/64	H85531/64			R95012.2	R96012.2	R97012.2		
31/64"						R95031/64	R96031/64	R97031/64		
12.5						R95012.5	R96012.5	R97012.5		
12.6						R95012.6	R96012.6	R97012.6		
1/2"	H85112.5	H85312.5	H85512.5	–	–	R9501/2	R9601/2	R9701/2		
12.8	H8511/2	H8531/2	H8551/2			R95012.8	R96012.8	R97012.8		
12.9						R95012.9	R96012.9	R97012.9		
13.0						R95013.0	R96013.0	R97013.0		
33/64"	H85113.0	H85313.0	H85513.0	–	–	R95033/64	R96033/64	R97033/64		
13.2	H85117/32	H85317/32	H85517/32			R95013.2	R96013.2	R97013.2		
17/32"						R95017/32	R96017/32	R97017/32		
13.5						R95013.5	R96013.5	R97013.5		
13.6						R95013.6	R96013.6	R97013.6		
13.7						R95013.7	R96013.7	R97013.7		
13.8						R95013.8	R96013.8	R97013.8	H860N1	H861N1
35/64"	H85114.0	H85314.0	H85514.0	H85814.0	H851214.0	R95035/64	R96035/64	R97035/64		
14.0	H8519/16	H8539/16	H8559/16			R95014.0	R96014.0	R97014.0		
14.1						R95014.1	R96014.1	R97014.1		
14.2						R95014.2	R96014.2	R97014.2		
9/16"						R9509/16	R9609/16	R9709/16		
14.5						R95014.5	R96014.5	R97014.5		
14.6						R95014.6	R96014.6	R97014.6		
37/64"						R95037/64	R96037/64	R97037/64		
14.7						R95014.7	R96014.7	R97014.7		
14.8						R95014.8	R96014.8	R97014.8		
15.0						R95015.0	R96015.0	R97015.0		
19/32"	H85115.0	H85315.0	H85515.0	H85815.0	H851215.0	R95019/32	R96019/32	R97019/32		
15.1	H85139/64	H85339/64	H85539/64			R95015.1	R96015.1	R97015.1		
15.2						R95015.2	R96015.2	R97015.2		
15.24						R95015.24	R96015.24	R97015.24		
39/64"						R95039/64	R96039/64	R97039/64		
15.5						R95015.5	R96015.5	R97015.5		



VYSOCE VÝKONNÉ VÝMĚNNÉ VRTÁKOVÉ HLAVY

DC	H851 1.5xD	H853 3xD	H855 5xD	H858 8xD	H8512 12xD	R950	R960	R970	H860	H861							
15.6	H85116.0 H85141/64	H85316.0 H85341/64	H85516.0 H85541/64	H85816.0	H851216.0	R95015.6	R96015.6	R97015.6	H860N2	H861N2							
15.7						R95015.7	R96015.7	R97015.7									
5/8"						R9505/8	R9605/8	R9705/8									
16.0						R95016.0	R96016.0	R97016.0									
16.08						R95016.08	R96016.08	R97016.08									
16.1						R95016.1	R96016.1	R97016.1									
16.2						R95016.2	R96016.2	R97016.2									
16.3						R95016.3	R96016.3	R97016.3									
41/64"						R95041/64	R96041/64	R97041/64									
16.5						R95016.5	R96016.5	R97016.5									
16.6	H85117.0 H85111/16	H85317.0 H85311/16	H85517.0 H85511/16	H85817.0	H851217.0	R95016.6	R96016.6	R97016.6	H860N2	H861N2							
21/32"						R95021/32	R96021/32	R97021/32									
16.7						R95016.7	R96016.7	R97016.7									
17.0						R95017.0	R96017.0	R97017.0									
43/64"						R95043/64	R96043/64	R97043/64									
17.1						R95017.1	R96017.1	R97017.1									
17.2						R95017.2	R96017.2	R97017.2									
11/16"						R95011/16	R96011/16	R97011/16									
17.5						R95017.5	R96017.5	R97017.5									
17.6						H85118.0 H85123/32	H85318.0 H85323/32	H85518.0 H85523/32			H85818.0	H851218.0	R95017.6	R96017.6	R97017.6	H860N2	H861N2
17.7	R95017.7	R96017.7	R97017.7														
45/64"	R95045/64	R96045/64	R97045/64														
18.0	R95018.0	R96018.0	R97018.0														
18.1	R95018.1	R96018.1	R97018.1														
18.2	R95018.2	R96018.2	R97018.2														
23/32"	R95023/32	R96023/32	R97023/32														
18.5	R95018.5	R96018.5	R97018.5														
18.6	H85119.0 H85149/64	H85319.0 H85349/64	H85519.0 H85549/64	H85819.0	H851219.0				R95018.6	R96018.6			R97018.6	H860N3	H861N3		
47/64"									R95047/64	R96047/64			R97047/64				
18.7						R95018.7	R96018.7	R97018.7									
18.9						R95018.9	R96018.9	R97018.9									
19.0						R95019.0	R96019.0	R97019.0									
3/4"						R9503/4	R9603/4	R9703/4									
19.1						R95019.1	R96019.1	R97019.1									
19.2						R95019.2	R96019.2	R97019.2									
19.25						R95019.25	R96019.25	R97019.25									
19.3						R95019.3	R96019.3	R97019.3									
19.35	R95019.35	R96019.35	R97019.35														
49/64"	R95049/64	R96049/64	R97049/64														
19.5	R95019.5	R96019.5	R97019.5	H860N4	H861N3												
19.6	R95019.6	R96019.6	R97019.6														
19.7	R95019.7	R96019.7	R97019.7														
25/32"	R95025/32	R96025/32	R97025/32														
20.0	R95020.0	R96020.0	R97020.0														
51/64"	R95051/64	R96051/64	R97051/64														
20.5	R95020.5	R96020.5	R97020.5														
13/16"	R95013/16	R96013/16	R97013/16														
21.0	R95021.0	R96021.0	R97021.0														
53/64"	R95053/64	R96053/64	R97053/64														
27/32"	R95027/32	R96027/32	R97027/32														
21.5	R95021.5	R96021.5	R97021.5	H860N4	H861N3												
55/64"	R95055/64	R96055/64	R97055/64														
22.0	R95022.0	R96022.0	R97022.0														
7/8"	R9507/8	R9607/8	R9707/8														
22.5	R95022.5	R96022.5	R97022.5														
57/64"	R95057/64	R96057/64	R97057/64														
22.7	R95022.7	R96022.7	R97022.7														
23.0	R95023.0	R96023.0	R97023.0														
29/32"	R95029/32	R96029/32	R97029/32														
59/64"	R95059/64	R96059/64	R97059/64														
23.5	R95023.5	R96023.5	R97023.5														



VYSOCE VÝKONNÉ VÝMĚNNÉ VRTÁKOVÉ HLAVY

DC	H851 1.5×D	H853 3×D	H855 5×D	H858 8×D	H8512 12×D	R950	R960	R970	H860	H861
15/16	H85124.0 H85131/32	H85324.0 H85331/32	H85524.0 H85531/32	H85824.0	H851224.0	R95015/16	R96015/16	R97015/16	H860N4	H861N3
24.0						R95024.0	R96024.0	R97024.0		
61/64						R95061/64	R96061/64	R97061/64		
24.5						R95024.5	R96024.5	R97024.5		
31/32"						R95031/32	R96031/32	R97031/32		
25.0	H85125.0 H8511.1/64	H85325.0 H8531.1/64	H85525.0 H8551.1/64	H85825.0	H851225.0	R95025.0	R96025.0	R97025.0	H860N5	H861N4
63/64"						R95063/64	R96063/64	R97063/64		
1"						R9501	R9601	R9701		
25.5						R95025.5	R96025.5	R97025.5		
25.6						R95025.6	–	–		
25.65						R95025.65	R96025.65	R97025.65		
1.1/64"						R9501.1/64	R9601.1/64	R9701.1/64		
26.0						R95026.0	R96026.0	R97026.0		
1.1/32"						R9501.1/32	R9601.1/32	R9701.1/32		
26.5						R95026.5	R96026.5	R97026.5		
1.3/64	R9501.3/64	R9601.3/64	R9701.3/64							
1.1/16"	H85127.0 H8511.3/32	H85327.0 H8531.3/32	H85527.0 H8551.3/32	H85827.0	–	R9501.1/16	R9601.1/16	R9701.1/16	H860N6	H861N5
27.0						R95027.0	R96027.0	R97027.0		
1.5/64"						R9501.5/64	R9601.5/64	R9701.5/64		
27.5						R95027.5	R96027.5	R97027.5		
1.3/32"						R9501.3/32	R9601.3/32	R9701.3/32		
28.0	H85128.0 H8511.1/8	H85328.0 H8531.1/8	H85528.0 H8551.1/8	H85828.0	–	R95028.0	R96028.0	R97028.0	H860N7	H861N6
1.7/64"						R9501.7/64	R9601.7/64	R9701.7/64		
28.5						R95028.5	R96028.5	R97028.5		
1.1/8"						R9501.1/8	R9601.1/8	R9701.1/8		
1.9/64"						R9501.9/64	R9601.9/64	R9701.9/64		
29.0	H85129.0 H8511.11/64	H85329.0 H8531.11/64	H85529.0 H8551.11/64	H85829.0	–	R95029.0	R96029.0	R97029.0	H860N8	H861N7
1.5/32"						R9501.5/32	R9601.5/32	R9701.5/32		
29.5						R95029.5	R96029.5	R97029.5		
1.11/64"						R9501.11/64	R9601.11/64	R9701.11/64		
30.0						R95030.0	R96030.0	R97030.0		
1.3/16"	H85130.0 H8511.3/16	H85330.0 H8531.3/16	H85530.0 H8551.3/16	H85830.0	–	R9501.3/16	R9601.3/16	R9701.3/16	H860N9	H861N8
30.5						R95030.5	R96030.5	R97030.5		
1.7/32"						R9501.7/32	–	R9701.7/32		
31.0						R95031.0	–	R97031.0		
1.1/4"						R9501.1/4	–	R9701.1/4		
32.0	–	H85332.0	H85532.0	H85832.0	–	R95032.0	–	R97032.0	H860N10	H861N9
32.5						R95032.5	–	R97032.5		
1.19/64"						R9501.19/64	–	R9701.19/64		
33.0						R95033.0	–	R97033.0		
33.5						R95033.5	–	R97033.5		
34.0	–	H85333.5	H85533.5	H85833.5	–	R95034.0	–	R97034.0	H860N11	H861N10
1.11/32"						R9501.11/32	–	R9701.11/32		
34.5						R95034.5	–	R97034.5		
1.3/8"						R9501.3/8	–	R9701.3/8		
35.0						R95035.0	–	R97035.0		
36.0	–	H85334.0	H85534.0	H85834.0	–	R95036.0	–	R97036.0	H860N12	H861N11
1.27/64"						R9501.27/64	–	R9701.27/64		
36.5						R95036.5	–	R97036.5		
37.0						R95037.0	–	R97037.0		
1.15/32"						R9501.15/32	–	R9701.15/32		
37.5	–	H85335.0	H85535.0	H85835.0	–	R95037.5	–	R97037.5	H860N13	H861N12
38.0						R95038.0	–	R97038.0		
1.1/2"						R9501.1/2	–	R9701.1/2		
38.5						R95038.5	–	R97038.5		
1.17/32"						R9501.17/32	–	R9701.17/32		
39.0	–	H85336.5	H85536.5	H85836.5	–	R95039.0	–	R97039.0	H860N14	H861N13
39.5						R95039.5	–	R97039.5		
1.9/16"						R9501.9/16	–	R9701.9/16		
40.0						R95040.0	–	R97040.0		
41.0						R95041.0	–	R97041.0		



VYSOCE VÝKONNÉ VÝMĚNNÉ VRTÁKOVÉ HLAVY

DC	H851 1.5×D	H853 3×D	H855 5×D	H858 8×D	H8512 12×D	R950	R960	R970	H860	H861
1.5/8" 42.0	–	H85342.5	H85542.5	H85842.5	–	R9501.5/8 R95042.0	– –	R9701.5/8 R97042.0	H860N7	H861N6

Příslušenství

H860	H861	Řada hlav Hydra Head DC			Velikost klíče / bit
		Metrické (min.–max.)	Ve zlomcích palců (min.–max.)	Desetinné (min.–max.)	
H860N1	H861N1	12.0 mm – 15.5 mm	15/32" – 39/64"	0.4688" – 0.6102"	8IP
H860N2	H861N2	15.6 mm – 18.5 mm	5/8" – 23/32"	0.6142" – 0.7283"	10IP
H860N3	H861N3	18.6 mm – 21.5 mm	47/64" – 27/32"	0.7323" – 0.8465"	15IP
H860N4	H861N3	22.0 mm – 24.5 mm	55/64" – 31/32"	0.8594" – 0.9688"	15IP
H860N5	H861N4	25.0 mm – 27.5 mm	63/64" – 1-3/32"	0.9843" – 1.0938"	20IP
H860N6	H861N5	28.0 mm – 33.5 mm	1-7/64" – 1-19/64"	1.1024" – 1.3189"	25IP
H860N7	H861N6	34.0 mm – 42.0 mm	1-11/32" – 1-5/8"	1.3386" – 1.6535"	4 mm



R950

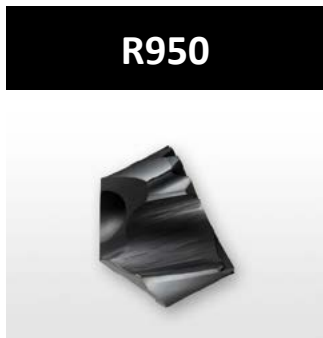

HYDRA Hlava pro ocel, Povlak Ti-phon

Vysoce ekonomická a přesná vyměnitelná hlava pro vrtání oceli a tvrdších materiálů. Vrcholový úhel 140° usnadňuje vystředění a snižuje řezné síly. Povlak Ti-phon zabraňuje nalepování třísek, odolává opotřebení a zvyšuje pevnost bříty.

HYDRA

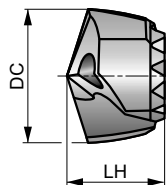

HM	DORMER	140°
Ti-phon	R	
DC h7		

H851	Použijte počáteční hodnoty pro řeznou rychlost a posuv s korekčním faktorem 1,10
H853	Použijte počáteční hodnoty pro řeznou rychlost a posuv s korekčním faktorem 1,00
H855	Použijte počáteční hodnoty pro řeznou rychlost a posuv s korekčním faktorem 0,95
H858	Použijte počáteční hodnoty pro řeznou rychlost a posuv s korekčním faktorem 0,90
H8512	Použijte počáteční hodnoty pro řeznou rychlost a posuv s korekčním faktorem 0,80

Skupiny obráběných materiálů, startovní řezná rychlost (Vc m/min) a kód posuvu.

P1.1 █ 133 W	P1.2 █ 148 W	P1.3 █ 154 W	P2.1 █ 114 W	P2.2 █ 100 W	P2.3 █ 88 W	P3.1 █ 125 W	P3.2 █ 101 W	P3.3 █ 85 W	P4.1 █ 75 W	P4.2 █ 63 W	P4.3 █ 52 T	M2.3 █ 41 T	M4.2 █ 35 T
K2.1 █ 108 V	K2.2 █ 88 V	K2.3 █ 70 V	K3.1 █ 96 V	K3.2 █ 73 V	K3.3 █ 59 V	K4.1 █ 89 V	K4.2 █ 67 V	K4.3 █ 49 V	K4.4 █ 42 V	K4.5 █ 35 V	K5.1 █ 100 V	K5.2 █ 76 V	K5.3 █ 58 V

Produkt	DC	DC	DC	LH
	(inch)	(mm)	(inch)	(mm)
R95015/32	15/32	11.91	0.4688	9.1
R95012.0	–	12.00	0.4724	9.1
R95012.1	–	12.10	0.4764	9.1
R95012.2	–	12.20	0.4803	9.1
R95031/64	31/64	12.30	0.4844	9.1
R95012.5	–	12.50	0.4921	9.4
R95012.6	–	12.60	0.4961	9.4
R9501/2	1/2	12.70	0.5000	9.4
R95012.8	–	12.80	0.5039	9.4
R95012.9	–	12.90	0.5079	9.4
R95013.0	–	13.00	0.5118	9.7
R95033/64	33/64	13.10	0.5156	9.7
R95013.2	–	13.20	0.5197	9.7
R95017/32	17/32	13.49	0.5313	9.7
R95013.5	–	13.50	0.5315	10.3
R95013.6	–	13.60	0.5354	10.3
R95013.7	–	13.70	0.5394	10.3
R95013.8	–	13.80	0.5433	10.3
R95035/64	35/64	13.89	0.5469	10.3
R95014.0	–	14.00	0.5512	10.3
R95014.1	–	14.10	0.5551	10.3
R95014.2	–	14.20	0.5591	10.3
R9509/16	9/16	14.29	0.5625	10.3
R95014.5	–	14.50	0.5709	10.3
R95014.6	–	14.60	0.5748	11.0
R95037/64	37/64	14.68	0.5781	11.0
R95014.7	–	14.70	0.5787	11.0
R95014.8	–	14.80	0.5827	11.0
R95015.0	–	15.00	0.5906	11.0
R95019/32	19/32	15.08	0.5938	11.0

Produkt	DC	DC	DC	LH
	(inch)	(mm)	(inch)	(mm)
R95015.1	–	15.10	0.5945	11.0
R95015.2	–	15.20	0.5984	11.0
R95015.24	–	15.24	0.6000	11.0
R95039/64	39/64	15.48	0.6094	11.0
R95015.5	–	15.50	0.6102	11.0
R95015.6	–	15.60	0.6142	11.6
R95015.7	–	15.70	0.6181	11.6
R9505/8	5/8	15.88	0.6250	11.6
R95016.0	–	16.00	0.6299	11.6
R95016.08	–	16.08	0.6331	11.6
R95016.1	–	16.10	0.6339	11.6
R95016.2	–	16.20	0.6378	11.6
R95041/64	41/64	16.27	0.6406	11.6
R95016.3	–	16.30	0.6417	11.6
R95016.5	–	16.50	0.6496	11.6
R95016.6	–	16.60	0.6535	12.2
R95021/32	21/32	16.67	0.6563	12.2
R95016.7	–	16.70	0.6575	12.2
R95017.0	–	17.00	0.6693	12.2
R95043/64	43/64	17.07	0.6719	12.2
R95017.1	–	17.10	0.6732	12.2
R95017.2	–	17.20	0.6772	12.2
R95011/16	11/16	17.46	0.6875	12.2
R95017.5	–	17.50	0.6890	12.2
R95017.6	–	17.60	0.6929	12.9
R95017.7	–	17.70	0.6969	12.9
R95045/64	45/64	17.86	0.7031	12.9
R95018.0	–	18.00	0.7087	12.9
R95018.1	–	18.10	0.7126	12.9
R95018.2	–	18.20	0.7165	12.9



Produkt	DC	DC	DC	LH
	(inch)	(mm)	(inch)	(mm)
R95023/32	23/32	18.26	0.7188	12.9
R95018.5	–	18.50	0.7283	12.9
R95018.6	–	18.60	0.7323	13.5
R95047/64	47/64	18.65	0.7344	13.5
R95018.7	–	18.70	0.7362	13.5
R95018.9	–	18.90	0.7441	13.5
R95019.0	–	19.00	0.7480	13.5
R9503/4	3/4	19.05	0.7500	13.5
R95019.1	–	19.10	0.7520	13.5
R95019.2	–	19.20	0.7559	13.5
R95019.25	–	19.25	0.7579	13.5
R95019.3	–	19.30	0.7598	13.5
R95019.35	–	19.35	0.7618	13.5
R95049/64	49/64	19.45	0.7656	13.5
R95019.5	–	19.50	0.7677	13.5
R95019.6	–	19.60	0.7717	14.1
R95019.7	–	19.70	0.7756	14.1
R95025/32	25/32	19.84	0.7813	14.1
R95020.0	–	20.00	0.7874	14.1
R95051/64	51/64	20.24	0.7969	14.1
R95020.5	–	20.50	0.8071	14.1
R95013/16	13/16	20.64	0.8125	14.8
R95021.0	–	21.00	0.8268	14.8
R95053/64	53/64	21.03	0.8281	14.8
R95027/32	27/32	21.43	0.8438	14.8
R95021.5	–	21.50	0.8465	14.8
R95055/64	55/64	21.83	0.8594	15.0
R95022.0	–	22.00	0.8661	15.0
R9507/8	7/8	22.22	0.8750	15.0
R95022.5	–	22.50	0.8858	15.0
R95057/64	57/64	22.62	0.8906	15.0
R95022.7	–	22.70	0.8937	15.0
R95023.0	–	23.00	0.9055	15.1
R95029/32	29/32	23.02	0.9063	15.1
R95059/64	59/64	23.42	0.9219	15.1
R95023.5	–	23.50	0.9252	15.1
R95015/16	15/16	23.81	0.9375	15.4
R95024.0	–	24.00	0.9449	15.4
R95061/64	61/64	24.21	0.9531	15.4
R95024.5	–	24.50	0.9646	15.4
R95031/32	31/32	24.61	0.9688	15.4
R95025.0	–	25.00	0.9844	15.8
R95063/64	63/64	25.00	0.9844	15.8
R9501	1"	25.40	1.0000	15.8
R95025.5	–	25.50	1.0039	15.8
R95025.6	–	25.60	1.0079	15.8
R95025.65	–	25.65	1.0098	15.8
R9501.1/64	1.1/64	25.80	1.0156	15.8
R95026.0	–	26.00	1.0236	16.4
R9501.1/32	1.1/32	26.19	1.0313	16.4

Produkt	DC	DC	DC	LH
	(inch)	(mm)	(inch)	(mm)
R95026.5	–	26.50	1.0433	16.4
R9501.3/64	1.3/64	26.59	1.0469	16.4
R9501.1/16	1.1/16	26.99	1.0625	17.1
R95027.0	–	27.00	1.0630	17.1
R9501.5/64	1.5/64	27.38	1.0781	17.1
R95027.5	–	27.50	1.0827	17.1
R9501.3/32	1.3/32	27.78	1.0938	17.1
R95028.0	–	28.00	1.1024	17.7
R9501.7/64	1.7/64	28.18	1.1094	17.7
R95028.5	–	28.50	1.1220	17.7
R9501.1/8	1.1/8	28.58	1.1250	17.7
R9501.9/64	1.9/64	28.97	1.1406	18.3
R95029.0	–	29.00	1.1417	18.3
R9501.5/32	1.5/32	29.37	1.1563	18.3
R95029.5	–	29.50	1.1614	18.3
R9501.11/64	1.11/64	29.77	1.1719	18.3
R95030.0	–	30.00	1.1811	19.0
R9501.3/16	1.3/16	30.16	1.1875	19.0
R95030.5	–	30.50	1.2008	19.0
R9501.7/32	1.7/32	30.96	1.2188	21.0
R95031.0	–	31.00	1.2205	21.0
R9501.1/4	1.1/4	31.75	1.2500	21.0
R95032.0	–	32.00	1.2598	21.0
R95032.5	–	32.50	1.2795	21.0
R9501.19/64	1.19/64	32.94	1.2969	21.0
R95033.0	–	33.00	1.2992	21.0
R95033.5	–	33.50	1.3189	21.0
R95034.0	–	34.00	1.3386	23.0
R9501.11/32	1.11/32	34.13	1.3438	23.0
R95034.5	–	34.50	1.3583	23.0
R9501.3/8	1.3/8	34.93	1.3750	23.0
R95035.0	–	35.00	1.3780	23.0
R95036.0	–	36.00	1.4173	23.0
R9501.27/64	1.27/64	36.12	1.4219	23.0
R95036.5	–	36.50	1.4370	23.0
R95037.0	–	37.00	1.4567	25.0
R9501.15/32	1.15/32	37.31	1.4688	25.0
R95037.5	–	37.50	1.4764	25.0
R95038.0	–	38.00	1.4961	25.0
R9501.1/2	1.1/2	38.10	1.5000	25.0
R95038.5	–	38.50	1.5157	25.0
R9501.17/32	1.17/32	38.89	1.5313	25.0
R95039.0	–	39.00	1.5354	25.0
R95039.5	–	39.50	1.5551	25.0
R9501.9/16	1.9/16	39.69	1.5625	27.0
R95040.0	–	40.00	1.5748	27.0
R95041.0	–	41.00	1.6142	27.0
R9501.5/8	1.5/8	41.28	1.6250	27.0
R95042.0	–	42.00	1.6535	27.0



R960

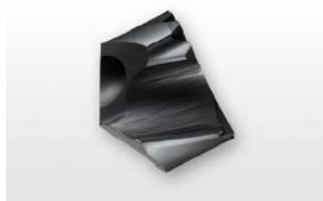

HYDRA Hlava pro nerez oceli, Povlak Ti-phon

Vysoce ekonomická a přesná vyměnitelná hlava pro vrtání nerez ocelí. Vrcholový úhel 140° usnadňuje vystředění a snižuje řezné síly. Povlak Ti-phon zabraňuje nalepování třísek, odolává opotřebení a zvyšuje pevnost bříty.

HYDRA

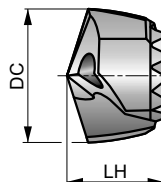

HM	DORMER	140°
Ti-phon	R	
DC h7		

H851	Použijte počáteční hodnoty pro řeznou rychlost a posuv s korekčním faktorem 1,10
H853	Použijte počáteční hodnoty pro řeznou rychlost a posuv s korekčním faktorem 1,00
H855	Použijte počáteční hodnoty pro řeznou rychlost a posuv s korekčním faktorem 0,95
H858	Použijte počáteční hodnoty pro řeznou rychlost a posuv s korekčním faktorem 0,90
H8512	Použijte počáteční hodnoty pro řeznou rychlost a posuv s korekčním faktorem 0,80

Skupiny obráběných materiálů, startovní řezná rychlost (Vc m/min) a kód posuvu.

P1.1 ■ 133 W	P1.2 ■ 148 W	P1.3 ■ 154 W	P2.1 ■ 114 W	M1.1 ■ 82 V	M1.2 ■ 70 V	M2.1 ■ 73 V	M2.2 ■ 60 V	M2.3 ▣ 50 T	M3.1 ■ 58 T	M3.2 ■ 50 T	M3.3 ■ 45 T	M4.1 ■ 40 T	M4.2 ▣ 34 T
K1.1 ■ 120 V	K1.2 ■ 89 V	K1.3 ■ 67 V	K2.1 ▣ 108 V	K2.2 ▣ 88 V	K2.3 ▣ 70 V	K3.1 ▣ 96 V	K3.2 ▣ 73 V	K3.3 ▣ 59 V	K4.1 ▣ 89 V	K4.2 ▣ 67 V	K4.3 ▣ 49 V	K4.4 ▣ 42 V	K4.5 ▣ 35 V
K5.1 ▣ 100 V	K5.2 ▣ 76 V	K5.3 ▣ 58 V	S1.1 ▣ 45 T	S1.2 ▣ 35 T	S1.3 ▣ 30 S	S2.1 ▣ 40 S	S2.2 ▣ 35 S	S3.1 ▣ 30 S	S3.2 ▣ 25 S	S4.1 ▣ 23 S	S4.2 ▣ 20 S		

Produkt	DC	DC	DC	LH
	(inch)	(mm)	(inch)	(mm)
R96015/32	15/32	11.91	0.4688	9.1
R96012.0	–	12.00	0.4724	9.1
R96012.1	–	12.10	0.4764	9.1
R96012.2	–	12.20	0.4803	9.1
R96031/64	31/64	12.30	0.4844	9.1
R96012.5	–	12.50	0.4921	9.4
R96012.6	–	12.60	0.4961	9.4
R9601/2	1/2	12.70	0.5000	9.4
R96012.8	–	12.80	0.5039	9.4
R96012.9	–	12.90	0.5079	9.4
R96013.0	–	13.00	0.5118	9.7
R96033/64	33/64	13.10	0.5156	9.7
R96013.2	–	13.20	0.5197	9.7
R96017/32	17/32	13.49	0.5313	9.7
R96013.5	–	13.50	0.5315	10.3
R96013.6	–	13.60	0.5354	10.3
R96013.7	–	13.70	0.5394	10.3
R96013.8	–	13.80	0.5433	10.3
R96035/64	35/64	13.89	0.5469	10.3
R96014.0	–	14.00	0.5512	10.3
R96014.1	–	14.10	0.5551	10.3
R96014.2	–	14.20	0.5591	10.3
R9609/16	9/16	14.29	0.5625	10.3
R96014.5	–	14.50	0.5709	10.3
R96014.6	–	14.60	0.5748	11.0
R96037/64	37/64	14.68	0.5781	11.0
R96014.7	–	14.70	0.5787	11.0
R96014.8	–	14.80	0.5827	11.0

Produkt	DC	DC	DC	LH
	(inch)	(mm)	(inch)	(mm)
R96015.0	–	15.00	0.5906	11.0
R96019/32	19/32	15.08	0.5938	11.0
R96015.1	–	15.10	0.5945	11.0
R96015.2	–	15.20	0.5984	11.0
R96015.24	–	15.24	0.6000	11.0
R96039/64	39/64	15.48	0.6094	11.0
R96015.5	–	15.50	0.6102	11.0
R96015.6	–	15.60	0.6142	11.6
R96015.7	–	15.70	0.6181	11.6
R9605/8	5/8	15.88	0.6250	11.6
R96016.0	–	16.00	0.6299	11.6
R96016.08	–	16.08	0.6331	11.6
R96016.1	–	16.10	0.6339	11.6
R96016.2	–	16.20	0.6378	11.6
R96041/64	41/64	16.27	0.6406	11.6
R96016.3	–	16.30	0.6417	11.6
R96016.5	–	16.50	0.6496	11.6
R96016.6	–	16.60	0.6535	12.2
R96021/32	21/32	16.67	0.6563	12.2
R96016.7	–	16.70	0.6575	12.2
R96017.0	–	17.00	0.6693	12.2
R96043/64	43/64	17.07	0.6719	12.2
R96017.1	–	17.10	0.6732	12.2
R96017.2	–	17.20	0.6772	12.2
R96011/16	11/16	17.46	0.6875	12.2
R96017.5	–	17.50	0.6890	12.2
R96017.6	–	17.60	0.6929	12.9
R96017.7	–	17.70	0.6969	12.9



Produkt	DC	DC	DC	LH
	(inch)	(mm)	(inch)	(mm)
R96045/64	45/64	17.86	0.7031	12.9
R96018.0	–	18.00	0.7087	12.9
R96018.1	–	18.10	0.7126	12.9
R96018.2	–	18.20	0.7165	12.9
R96023/32	23/32	18.26	0.7188	12.9
R96018.5	–	18.50	0.7283	12.9
R96018.6	–	18.60	0.7323	13.5
R96047/64	47/64	18.65	0.7344	13.5
R96018.7	–	18.70	0.7362	13.5
R96018.9	–	18.90	0.7441	13.5
R96019.0	–	19.00	0.7480	13.5
R9603/4	3/4	19.05	0.7500	13.5
R96019.1	–	19.10	0.7520	13.5
R96019.2	–	19.20	0.7559	13.5
R96019.25	–	19.25	0.7579	13.5
R96019.3	–	19.30	0.7598	13.5
R96019.35	–	19.35	0.7618	13.5
R96049/64	49/64	19.45	0.7656	13.5
R96019.5	–	19.50	0.7677	13.5
R96019.6	–	19.60	0.7717	14.1
R96019.7	–	19.70	0.7756	14.1
R96025/32	25/32	19.84	0.7813	14.1
R96020.0	–	20.00	0.7874	14.1
R96051/64	51/64	20.24	0.7969	14.1
R96020.5	–	20.50	0.8071	14.1
R96013/16	13/16	20.64	0.8125	14.8
R96021.0	–	21.00	0.8268	14.8
R96053/64	53/64	21.03	0.8281	14.8
R96027/32	27/32	21.43	0.8438	14.8
R96021.5	–	21.50	0.8465	14.8
R96055/64	55/64	21.83	0.8594	15.0
R96022.0	–	22.00	0.8661	15.0
R9607/8	7/8	22.22	0.8750	15.0
R96022.5	–	22.50	0.8858	15.0
R96057/64	57/64	22.62	0.8906	15.0
R96022.7	–	22.70	0.8937	15.0

Produkt	DC	DC	DC	LH
	(inch)	(mm)	(inch)	(mm)
R96023.0	–	23.00	0.9055	15.1
R96029/32	29/32	23.02	0.9063	15.1
R96059/64	59/64	23.42	0.9219	15.1
R96023.5	–	23.50	0.9252	15.1
R96015/16	15/16	23.81	0.9375	15.4
R96024.0	–	24.00	0.9449	15.4
R96061/64	61/64	24.21	0.9531	15.4
R96024.5	–	24.50	0.9646	15.4
R96031/32	31/32	24.61	0.9688	15.4
R96025.0	–	25.00	0.9844	15.8
R96063/64	63/64	25.00	0.9844	15.8
R9601	1"	25.40	1.0000	15.8
R96025.5	–	25.50	1.0039	15.8
R96025.65	–	25.65	1.0098	15.8
R9601.1/64	1.1/64	25.80	1.0156	15.8
R96026.0	–	26.00	1.0236	16.4
R9601.1/32	1.1/32	26.19	1.0313	16.4
R96026.5	–	26.50	1.0433	16.4
R9601.3/64	1.3/64	26.59	1.0469	16.4
R9601.1/16	1.1/16	26.99	1.0625	17.1
R96027.0	–	27.00	1.0630	17.1
R9601.5/64	1.5/64	27.38	1.0781	17.1
R96027.5	–	27.50	1.0827	17.1
R9601.3/32	1.3/32	27.78	1.0938	17.1
R96028.0	–	28.00	1.1024	17.7
R9601.7/64	1.7/64	28.18	1.1094	17.7
R96028.5	–	28.50	1.1220	17.7
R9601.1/8	1.1/8	28.58	1.1250	17.7
R9601.9/64	1.9/64	28.97	1.1406	18.3
R96029.0	–	29.00	1.1417	18.3
R9601.5/32	1.5/32	29.37	1.1563	18.3
R96029.5	–	29.50	1.1614	18.3
R9601.11/64	1.11/64	29.77	1.1719	18.3
R96030.0	–	30.00	1.1811	19.0
R9601.3/16	1.3/16	30.16	1.1875	19.0
R96030.5	–	30.50	1.2008	19.0



R970



HYDRA Hlava pro litinu, Povlak Ti-phon

Vysoce ekonomická a přesná vyměnitelná hlava pro vrtání litiny. Vrcholový úhel 140° usnadňuje vystředění a snižuje řezné síly. Povlak Ti-phon zabraňuje nalepování třísek, odolává opotřebení a zvyšuje pevnost bříty.

HYDRA

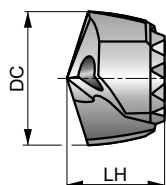

HM	DORMER	140°
Ti-phon	R	
DC h7		

H851	Použijte počáteční hodnoty pro řeznou rychlost a posuv s korekčním faktorem 1,10
H853	Použijte počáteční hodnoty pro řeznou rychlost a posuv s korekčním faktorem 1,00
H855	Použijte počáteční hodnoty pro řeznou rychlost a posuv s korekčním faktorem 0,95
H858	Použijte počáteční hodnoty pro řeznou rychlost a posuv s korekčním faktorem 0,90
H8512	Použijte počáteční hodnoty pro řeznou rychlost a posuv s korekčním faktorem 0,80

Skupiny obráběných materiálů, startovní řezná rychlost (Vc m/min) a kód posuvu.

K1.1 ■ 120 V	K1.2 ■ 89 V	K1.3 ■ 67 V	K2.1 ■ 98 V	K2.2 ■ 80 V	K2.3 ■ 64 V	K3.1 ■ 97 V	K3.2 ■ 67 V	K3.3 ■ 54 V	K4.1 ■ 81 V	K4.2 ■ 61 V	K4.3 ■ 45 V	K4.4 ■ 38 V	K4.5 ■ 32 V
K5.1 ■ 91 V	K5.2 ■ 69 V	K5.3 ■ 53 V											

Produkt	DC	DC	DC	LH
	(inch)	(mm)	(inch)	(mm)
R97015/32	15/32	11.91	0.4688	9.1
R97012.0	–	12.00	0.4724	9.1
R97012.1	–	12.10	0.4764	9.1
R97012.2	–	12.20	0.4803	9.1
R97031/64	31/64	12.30	0.4844	9.1
R97012.5	–	12.50	0.4921	9.4
R97012.6	–	12.60	0.4961	9.4
R9701/2	1/2	12.70	0.5000	9.4
R97012.8	–	12.80	0.5039	9.4
R97012.9	–	12.90	0.5079	9.4
R97013.0	–	13.00	0.5118	9.7
R97033/64	33/64	13.10	0.5156	9.7
R97013.2	–	13.20	0.5197	9.7
R97017/32	17/32	13.49	0.5313	9.7
R97013.5	–	13.50	0.5315	10.3
R97013.6	–	13.60	0.5354	10.3
R97013.7	–	13.70	0.5394	10.3
R97013.8	–	13.80	0.5433	10.3
R97035/64	35/64	13.89	0.5469	10.3
R97014.0	–	14.00	0.5512	10.3
R97014.1	–	14.10	0.5551	10.3
R97014.2	–	14.20	0.5591	10.3
R9709/16	9/16	14.29	0.5625	10.3
R97014.5	–	14.50	0.5709	10.3
R97014.6	–	14.60	0.5748	11.0
R97037/64	37/64	14.68	0.5781	11.0
R97014.7	–	14.70	0.5787	11.0
R97014.8	–	14.80	0.5827	11.0
R97015.0	–	15.00	0.5906	11.0
R97019/32	19/32	15.08	0.5938	11.0

Produkt	DC	DC	DC	LH
	(inch)	(mm)	(inch)	(mm)
R97015.1	–	15.10	0.5945	11.0
R97015.2	–	15.20	0.5984	11.0
R97015.24	–	15.24	0.6000	11.0
R97039/64	39/64	15.48	0.6094	11.0
R97015.5	–	15.50	0.6102	11.0
R97015.6	–	15.60	0.6142	11.6
R97015.7	–	15.70	0.6181	11.6
R9705/8	5/8	15.88	0.6250	11.6
R97016.0	–	16.00	0.6299	11.6
R97016.08	–	16.08	0.6331	11.6
R97016.1	–	16.10	0.6339	11.6
R97016.2	–	16.20	0.6378	11.6
R97041/64	41/64	16.27	0.6406	11.6
R97016.3	–	16.30	0.6417	11.6
R97016.5	–	16.50	0.6496	11.6
R97016.6	–	16.60	0.6535	12.2
R97021/32	21/32	16.67	0.6563	12.2
R97016.7	–	16.70	0.6575	12.2
R97017.0	–	17.00	0.6693	12.2
R97043/64	43/64	17.07	0.6719	12.2
R97017.1	–	17.10	0.6732	12.2
R97017.2	–	17.20	0.6772	12.2
R97011/16	11/16	17.46	0.6875	12.2
R97017.5	–	17.50	0.6890	12.2
R97017.6	–	17.60	0.6929	12.9
R97017.7	–	17.70	0.6969	12.9
R97045/64	45/64	17.86	0.7031	12.9
R97018.0	–	18.00	0.7087	12.9
R97018.1	–	18.10	0.7126	12.9
R97018.2	–	18.20	0.7165	12.9



Produkt	DC	DC	DC	LH
	(inch)	(mm)	(inch)	(mm)
R97023/32	23/32	18.26	0.7188	12.9
R97018.5	–	18.50	0.7283	12.9
R97018.6	–	18.60	0.7323	13.5
R97047/64	47/64	18.65	0.7344	13.5
R97018.7	–	18.70	0.7362	13.5
R97018.9	–	18.90	0.7441	13.5
R97019.0	–	19.00	0.7480	13.5
R9703/4	3/4	19.05	0.7500	13.5
R97019.1	–	19.10	0.7520	13.5
R97019.2	–	19.20	0.7559	13.5
R97019.25	–	19.25	0.7579	13.5
R97019.3	–	19.30	0.7598	13.5
R97019.35	–	19.35	0.7618	13.5
R97049/64	49/64	19.45	0.7656	13.5
R97019.5	–	19.50	0.7677	13.5
R97019.6	–	19.60	0.7717	14.1
R97019.7	–	19.70	0.7756	14.1
R97025/32	25/32	19.84	0.7813	14.1
R97020.0	–	20.00	0.7874	14.1
R97051/64	51/64	20.24	0.7969	14.1
R97020.5	–	20.50	0.8071	14.1
R97013/16	13/16	20.64	0.8125	14.8
R97021.0	–	21.00	0.8268	14.8
R97053/64	53/64	21.03	0.8281	14.8
R97027/32	27/32	21.43	0.8438	14.8
R97021.5	–	21.50	0.8465	14.8
R97055/64	55/64	21.83	0.8594	15.0
R97022.0	–	22.00	0.8661	15.0
R9707/8	7/8	22.22	0.8750	15.0
R97022.5	–	22.50	0.8858	15.0
R97057/64	57/64	22.62	0.8906	15.0
R97022.7	–	22.70	0.8937	15.0
R97023.0	–	23.00	0.9055	15.1
R97029/32	29/32	23.02	0.9063	15.1
R97059/64	59/64	23.42	0.9219	15.1
R97023.5	–	23.50	0.9252	15.1
R97015/16	15/16	23.81	0.9375	15.4
R97024.0	–	24.00	0.9449	15.4
R97061/64	61/64	24.21	0.9531	15.4
R97024.5	–	24.50	0.9646	15.4
R97031/32	31/32	24.61	0.9688	15.4
R97025.0	–	25.00	0.9844	15.8
R97063/64	63/64	25.00	0.9844	15.8
R9701	1"	25.40	1.0000	15.8
R97025.5	–	25.50	1.0039	15.8
R97025.65	–	25.65	1.0098	15.8
R9701.1/64	1.1/64	25.80	1.0156	15.8
R97026.0	–	26.00	1.0236	16.4
R9701.1/32	1.1/32	26.19	1.0313	16.4

Produkt	DC	DC	DC	LH
	(inch)	(mm)	(inch)	(mm)
R97026.5	–	26.50	1.0433	16.4
R9701.3/64	1.3/64	26.59	1.0469	16.4
R9701.1/16	1.1/16	26.99	1.0625	17.1
R97027.0	–	27.00	1.0630	17.1
R9701.5/64	1.5/64	27.38	1.0781	17.1
R97027.5	–	27.50	1.0827	17.1
R9701.3/32	1.3/32	27.78	1.0938	17.1
R97028.0	–	28.00	1.1024	17.7
R9701.7/64	1.7/64	28.18	1.1094	17.7
R97028.5	–	28.50	1.1220	17.7
R9701.1/8	1.1/8	28.58	1.1250	17.7
R9701.9/64	1.9/64	28.97	1.1406	18.3
R97029.0	–	29.00	1.1417	18.3
R9701.5/32	1.5/32	29.37	1.1563	18.3
R97029.5	–	29.50	1.1614	18.3
R9701.11/64	1.11/64	29.77	1.1719	18.3
R97030.0	–	30.00	1.1811	19.0
R9701.3/16	1.3/16	30.16	1.1875	19.0
R97030.5	–	30.50	1.2008	19.0
R9701.7/32	1.7/32	30.96	1.2188	21.0
R97031.0	–	31.00	1.2205	21.0
R9701.1/4	1.1/4	31.75	1.2500	21.0
R97032.0	–	32.00	1.2598	21.0
R97032.5	–	32.50	1.2795	21.0
R9701.19/64	1.19/64	32.94	1.2969	21.0
R97033.0	–	33.00	1.2992	21.0
R97033.5	–	33.50	1.3189	21.0
R97034.0	–	34.00	1.3386	23.0
R9701.11/32	1.11/32	34.13	1.3438	23.0
R97034.5	–	34.50	1.3583	23.0
R9701.3/8	1.3/8	34.93	1.3750	23.0
R97035.0	–	35.00	1.3780	23.0
R97036.0	–	36.00	1.4173	23.0
R9701.27/64	1.27/64	36.12	1.4219	23.0
R97036.5	–	36.50	1.4370	23.0
R97037.0	–	37.00	1.4567	25.0
R9701.15/32	1.15/32	37.31	1.4688	25.0
R97037.5	–	37.50	1.4764	25.0
R97038.0	–	38.00	1.4961	25.0
R9701.1/2	1.1/2	38.10	1.5000	25.0
R97038.5	–	38.50	1.5157	25.0
R9701.17/32	1.17/32	38.89	1.5313	25.0
R97039.0	–	39.00	1.5354	25.0
R97039.5	–	39.50	1.5551	25.0
R9701.9/16	1.9/16	39.69	1.5625	27.0
R97040.0	–	40.00	1.5748	27.0
R97041.0	–	41.00	1.6142	27.0
R9701.5/8	1.5/8	41.28	1.6250	27.0
R97042.0	–	42.00	1.6535	27.0

NEW**H851****DORMER**

Těleso vrtáku HYDRA 1.5xD s vnitřním chlazením, Povrchová úprava lesklé niklování

Použití pro upnutí hlav HYDRA R950, R960 a R970. Několik velikostí hlav může být upínáno do téhož tělesa vrtáku. Vnitřní chlazení pro zlepšení chladicího efektu. Povrchová úprava lesklým niklováním brání korozi a zlepšuje odvod třísek.

HYDRA

HSS	DORMER	1.5xD
Bright Ni	ISO 9766	R

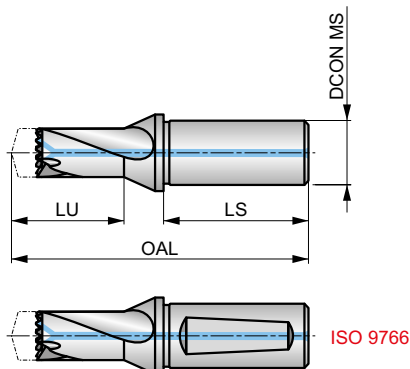

Součástí balení jsou 4 ks šroubků a 1 ks šroubováku, DCON MS v toleranci h6.

Produkt	DCONMS	DCON MS	LU	OAL	LS	ADINTMS
	(inch)	(mm)	(mm)	(mm)	(mm)	
H85131/64	5/8	15.88	25.50	88.5	47.6	Cylindrical
H8511/2	5/8	15.88	25.80	88.8	47.6	Cylindrical
H85117/32	5/8	15.88	30.90	93.9	47.6	Cylindrical
H85112.0	–	16.00	25.50	88.5	48.0	ISO 9766
H85112.5	–	16.00	25.80	88.8	48.0	ISO 9766
H85113.0	–	16.00	27.00	90.0	48.0	ISO 9766
H85114.0	–	16.00	30.90	93.9	48.0	ISO 9766
H8519/16	3/4	19.05	30.30	93.9	50.8	Cylindrical
H85139/64	3/4	19.05	32.30	97.3	50.8	Cylindrical
H85141/64	3/4	19.05	34.90	99.9	50.8	Cylindrical
H85111/16	3/4	19.05	36.40	101.4	50.8	Cylindrical
H85123/32	3/4	19.05	39.00	104.0	50.8	Cylindrical
H85115.0	–	20.00	32.30	97.3	50.0	ISO 9766
H85116.0	–	20.00	34.90	99.9	50.0	ISO 9766
H85117.0	–	20.00	36.40	101.4	50.0	ISO 9766
H85118.0	–	20.00	39.00	104.0	50.0	ISO 9766
H85119.0	–	25.00	40.40	111.4	56.0	ISO 9766
H85120.0	–	25.00	43.00	114.0	56.0	ISO 9766
H85121.0	–	25.00	44.50	115.5	56.0	ISO 9766
H85122.0	–	25.00	46.10	117.1	56.0	ISO 9766
H85123.0	–	25.00	47.00	118.0	56.0	ISO 9766
H85149/64	1"	25.40	40.40	111.4	57.1	Cylindrical
H85151/64	1"	25.40	43.00	114.0	57.1	Cylindrical
H85127/32	1"	25.40	44.50	115.5	57.1	Cylindrical
H85157/64	1"	25.40	46.10	117.1	57.1	Cylindrical
H85159/64	1"	25.40	47.00	118.0	57.1	Cylindrical
H85131/32	1"	25.40	49.30	124.3	57.1	Cylindrical
H8511.1/64	1.1/4	31.75	49.70	124.7	60.3	Cylindrical
H8511.3/64	1.1/4	31.75	52.30	127.3	60.3	Cylindrical
H8511.3/32	1.1/4	31.75	52.80	127.8	60.3	Cylindrical
H8511.1/8	1.1/4	31.75	54.40	129.4	60.3	Cylindrical
H8511.11/64	1.1/4	31.75	55.80	130.8	60.3	Cylindrical
H8511.3/16	1.1/4	31.75	58.40	133.4	60.3	Cylindrical
H85124.0	–	32.00	49.30	124.3	60.0	ISO 9766



Produkt	DCONMS	DCON MS	LU	OAL	LS	ADINTMS
	(inch)	(mm)	(mm)	(mm)	(mm)	
H85125.0	–	32.00	49.70	124.7	60.0	ISO 9766
H85126.0	–	32.00	52.30	127.3	60.0	ISO 9766
H85127.0	–	32.00	52.80	127.8	60.0	ISO 9766
H85128.0	–	32.00	54.40	129.4	60.0	ISO 9766
H85129.0	–	32.00	55.80	130.8	60.0	ISO 9766
H85130.0	–	32.00	58.40	133.4	60.0	ISO 9766



H853



Těleso vrtáku HYDRA 3xD s vnitřním chlazením, Povrchová úprava lesklé niklování

Použití pro upnutí hlav HYDRA R950, R960 a R970. Několik velikostí hlav může být upínáno do téhož tělesa vrtáku. Vnitřní chlazení pro zlepšení chladicího efektu. Povrchová úprava lesklým niklováním brání korozi a zlepšuje odvod třísek.

HYDRA

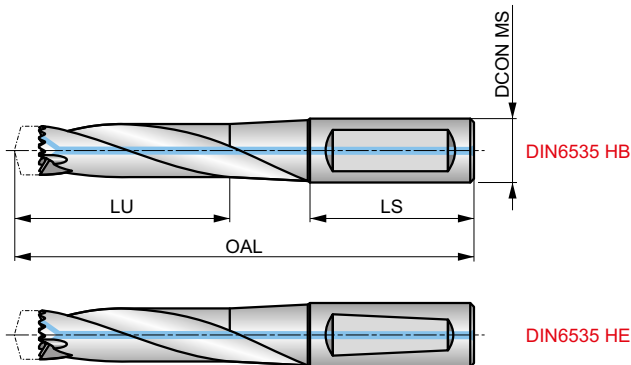

HSS	DORMER	3xD
Bright Ni	DIN 6535HB DIN 6535HE	R

Součástí balení jsou 4 ks šroubků a 1 ks šroubováku, DCON MS v toleranci h6.

Produkt	DCONMS	DCON MS	LU	OAL	LS	ADINTMS
	(inch)	(mm)	(mm)	(mm)	(mm)	
H85312.0	–	16.00	44.00	105.0	48.0	DIN6535HE
H85331/64	5/8	15.88	44.00	105.0	48.0	DIN6535HB
H85312.5	–	16.00	44.00	105.0	48.0	DIN6535HE
H8531/2	5/8	15.88	44.00	105.0	48.0	DIN6535HB
H85313.0	–	16.00	47.00	110.0	48.0	DIN6535HE
H85317/32	5/8	15.88	47.00	110.0	48.0	DIN6535HB
H85314.0	–	16.00	52.50	116.5	48.0	DIN6535HE
H8539/16	3/4	19.05	52.50	116.5	48.0	DIN6535HB
H85315.0	–	20.00	55.50	126.5	50.0	DIN6535HE
H85339/64	3/4	19.05	55.50	126.5	50.0	DIN6535HB
H85316.0	–	20.00	59.50	131.5	50.0	DIN6535HE
H85341/64	3/4	19.05	59.50	131.5	50.0	DIN6535HB
H85317.0	–	20.00	62.50	136.5	50.0	DIN6535HE
H85311/16	3/4	19.05	62.50	136.5	50.0	DIN6535HB
H85318.0	–	20.00	66.50	141.5	50.0	DIN6535HE
H85323/32	3/4	19.05	66.50	141.5	50.0	DIN6535HB
H85319.0	–	25.00	69.50	156.5	56.0	DIN6535HE
H85349/64	1"	25.40	69.50	156.5	56.0	DIN6535HB
H85320.0	–	25.00	73.50	156.5	56.0	DIN6535HE
H85351/64	1"	25.40	73.50	156.5	56.0	DIN6535HB
H85321.0	–	25.00	76.50	156.5	56.0	DIN6535HE
H85327/32	1"	25.40	76.50	156.5	56.0	DIN6535HB
H85322.0	–	25.00	80.10	161.5	56.0	DIN6535HE
H85357/64	1"	25.40	80.10	161.5	56.0	DIN6535HB
H85323.0	–	25.00	82.50	160.5	56.0	DIN6535HE
H85359/64	1"	25.40	82.50	160.5	56.0	DIN6535HB
H85324.0	–	32.00	86.20	170.2	60.0	DIN6535HE
H85331/32	1"	25.40	86.20	170.2	60.0	DIN6535HB
H85325.0	–	32.00	88.00	170.0	60.0	DIN6535HE
H8531.1/64	1.1/4	31.75	88.00	170.0	60.0	DIN6535HB
H85326.0	–	32.00	92.00	175.0	60.0	DIN6535HE
H8531.3/64	1.1/4	31.75	92.00	175.0	60.0	DIN6535HB
H85327.0	–	32.00	94.00	175.0	60.0	DIN6535HE
H8531.3/32	1.1/4	31.75	94.00	175.0	60.0	DIN6535HB



Produkt	DCONMS	DCON MS	LU	OAL	LS	ADINTMS
	(inch)	(mm)	(mm)	(mm)	(mm)	
H85328.0	–	32.00	97.00	180.0	60.0	DIN6535HE
H8531.1/8	1.1/4	31.75	97.00	180.0	60.0	DIN6535HB
H85329.0	–	32.00	100.00	185.0	60.0	DIN6535HE
H8531.11/64	1.1/4	31.75	100.00	185.0	60.0	DIN6535HB
H85330.0	–	32.00	104.00	185.0	60.0	DIN6535HE
H8531.3/16	1.1/4	31.75	104.00	185.0	60.0	DIN6535HB
H85332.0	–	32.00	111.50	196.5	60.0	DIN6535HE
H85333.5	–	32.00	116.50	201.5	60.0	DIN6535HE
H85335.0	–	40.00	121.50	216.5	70.0	DIN6535HB
H85336.5	–	40.00	125.50	221.5	70.0	DIN6535HB
H85338.0	–	40.00	131.50	226.5	70.0	DIN6535HB
H85339.5	–	40.00	136.50	231.5	70.0	DIN6535HB
H85341.0	–	40.00	146.50	246.5	70.0	DIN6535HB
H85342.5	–	40.00	151.60	251.6	70.0	DIN6535HB



H855

DORMER



Těleso vrtáku HYDRA 5xD s vnitřním chlazením, Povrchová úprava lesklé niklování

Použití pro upnutí hlav HYDRA R950, R960 a R970. Několik velikostí hlav může být upínáno do téhož tělesa vrtáku. Vnitřní chlazení pro zlepšení chladicího efektu. Povrchová úprava lesklým niklováním brání korozi a zlepšuje odvod třísek.

HYDRA

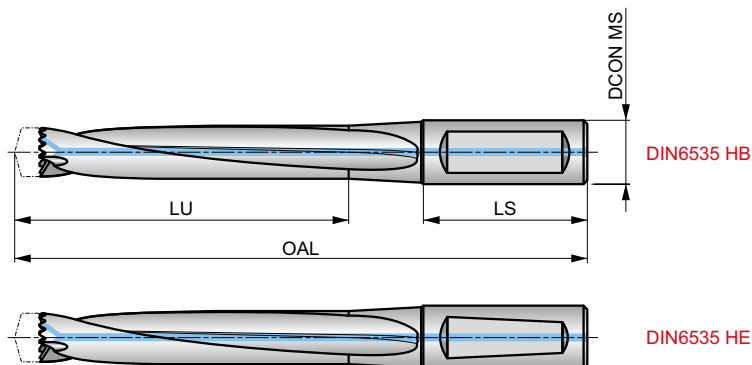

HSS	DORMER	5xD
Bright Ni	DIN 6535HB DIN 6535HE	R

Součástí balení jsou 4 ks šroubků a 1 ks šroubovák, DCON MS v toleranci h6.

Produkt	DCONMS	DCON MS	LU	OAL	LS	ADINTMS
	(inch)	(mm)	(mm)	(mm)	(mm)	
H85512.0	–	16.00	69.00	130.0	48.0	DIN6535HE
H85531/64	5/8	15.88	69.00	130.0	48.0	DIN6535HB
H85512.5	–	16.00	69.00	130.0	48.0	DIN6535HE
H8551/2	5/8	15.88	69.00	130.0	48.0	DIN6535HB
H85513.0	–	16.00	74.00	140.0	48.0	DIN6535HE
H85517/32	5/8	15.88	74.00	140.0	48.0	DIN6535HB
H85514.0	–	16.00	81.50	146.5	48.0	DIN6535HE
H8559/16	3/4	19.05	81.50	146.5	48.0	DIN6535HB
H85515.0	–	20.00	86.50	156.5	50.0	DIN6535HE
H85539/64	3/4	19.05	86.50	156.5	50.0	DIN6535HB
H85516.0	–	20.00	92.50	166.5	50.0	DIN6535HE
H85541/64	3/4	19.05	92.50	166.5	50.0	DIN6535HB
H85517.0	–	20.00	97.50	171.5	50.0	DIN6535HE
H85511/16	3/4	19.05	97.50	171.5	50.0	DIN6535HB
H85518.0	–	20.00	103.50	176.5	50.0	DIN6535HE
H85523/32	3/4	19.05	103.50	176.5	50.0	DIN6535HB
H85519.0	–	25.00	108.50	191.5	56.0	DIN6535HE
H85549/64	1"	25.40	108.50	191.5	56.0	DIN6535HB
H85520.0	–	25.00	114.50	196.5	56.0	DIN6535HE
H85551/64	1"	25.40	114.50	196.5	56.0	DIN6535HB
H85521.0	–	25.00	119.50	196.5	56.0	DIN6535HE
H85527/32	1"	25.40	119.50	196.5	56.0	DIN6535HB
H85522.0	–	25.00	125.10	201.1	56.0	DIN6535HE
H85557/64	1"	25.40	125.10	201.1	56.0	DIN6535HB
H85523.0	–	25.00	129.50	210.5	56.0	DIN6535HE
H85559/64	1"	25.40	129.50	210.5	56.0	DIN6535HB
H85524.0	–	32.00	135.20	220.2	60.0	DIN6535HE
H85531/32	1"	25.40	135.20	220.2	60.0	DIN6535HB
H85525.0	–	32.00	140.00	225.0	60.0	DIN6535HE
H8551.1/64	1.1/4	31.75	140.00	225.0	60.0	DIN6535HB
H85526.0	–	32.00	146.00	230.0	60.0	DIN6535HE
H8551.3/64	1.1/4	31.75	146.00	230.0	60.0	DIN6535HB
H85527.0	–	32.00	151.00	235.0	60.0	DIN6535HE
H8551.3/32	1.1/4	31.75	151.00	235.0	60.0	DIN6535HB



Produkt	DCONMS	DCON MS	LU	OAL	LS	ADINTMS
	(inch)	(mm)	(mm)	(mm)	(mm)	
H85528.0	–	32.00	157.00	240.0	60.0	DIN6535HE
H8551.1/8	1.1/4	31.75	157.00	240.0	60.0	DIN6535HB
H85529.0	–	32.00	162.00	245.0	60.0	DIN6535HE
H8551.11/64	1.1/4	31.75	162.00	245.0	60.0	DIN6535HB
H85530.0	–	32.00	167.00	255.0	60.0	DIN6535HE
H8551.3/16	1.1/4	31.75	167.00	255.0	60.0	DIN6535HB
H85532.0	–	32.00	176.50	261.5	60.0	DIN6535HE
H85533.5	–	32.00	186.50	271.5	60.0	DIN6535HE
H85535.0	–	40.00	196.50	291.5	70.0	DIN6535HB
H85536.5	–	40.00	201.50	296.5	70.0	DIN6535HB
H85538.0	–	40.00	211.50	306.5	70.0	DIN6535HB
H85539.5	–	40.00	221.50	316.5	70.0	DIN6535HB
H85541.0	–	40.00	226.50	325.6	70.0	DIN6535HB
H85542.5	–	40.00	236.50	336.5	70.0	DIN6535HB



H858



Těleso vrtáku HYDRA 8xD s vnitřním chlazením, Povrchová úprava lesklé niklování

Použití pro upnutí hlav HYDRA R950, R960 a R970. Několik velikostí hlav může být upínáno do téhož tělesa vrtáku. Vnitřní chlazení pro zlepšení chladicího efektu. Povrchová úprava lesklým niklováním brání korozi a zlepšuje odvod třísek.

HYDRA

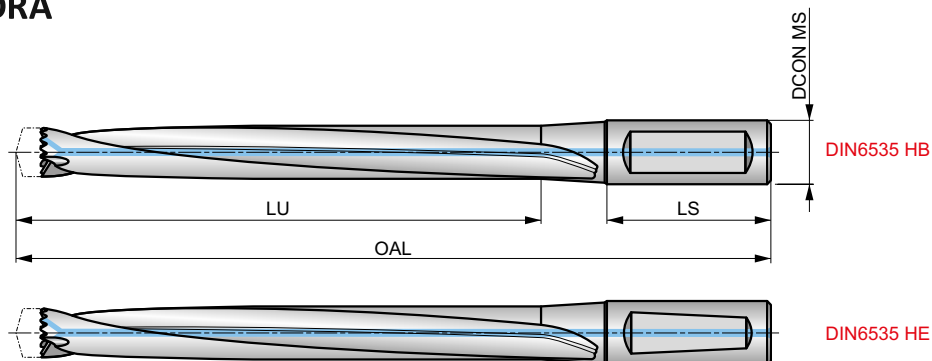

HSS		8xD
Bright Ni	DIN 6535HB DIN 6535HE	

Součástí balení jsou 4 ks šroubků a 1 ks šroubováku, DCON MS v toleranci h6.

Produkt	DCON MS (mm)	LU (mm)	OAL (mm)	LS (mm)	ADINTMS
H85814.0	16.00	124.50	191.5	48.0	DIN6535HE
H85815.0	20.00	133.50	201.5	50.0	DIN6535HE
H85816.0	20.00	141.50	211.5	50.0	DIN6535HE
H85817.0	20.00	150.50	221.5	50.0	DIN6535HE
H85818.0	20.00	158.50	226.5	50.0	DIN6535HE
H85819.0	25.00	167.50	251.5	56.0	DIN6535HE
H85820.0	25.00	175.50	264.5	56.0	DIN6535HE
H85821.0	25.00	184.50	266.5	56.0	DIN6535HE
H85822.0	25.00	192.10	271.1	56.0	DIN6535HE
H85823.0	25.00	200.50	280.5	56.0	DIN6535HE
H85824.0	32.00	208.20	295.2	60.0	DIN6535HE
H85825.0	32.00	217.00	300.0	60.0	DIN6535HE
H85826.0	32.00	225.00	310.0	60.0	DIN6535HE
H85827.0	32.00	234.00	320.0	60.0	DIN6535HE
H85828.0	32.00	242.00	325.0	60.0	DIN6535HE
H85829.0	32.00	251.00	335.0	60.0	DIN6535HE
H85830.0	32.00	259.00	345.0	60.0	DIN6535HE
H85832.0	32.00	271.50	356.5	60.0	DIN6535HE
H85833.5	32.00	286.50	371.5	60.0	DIN6535HE
H85835.0	40.00	301.50	396.5	70.0	DIN6535HB
H85836.5	40.00	311.50	406.5	70.0	DIN6535HB
H85838.0	40.00	326.50	421.5	70.0	DIN6535HB
H85839.5	40.00	336.50	431.5	70.0	DIN6535HB
H85841.0	40.00	351.50	451.5	70.0	DIN6535HB
H85842.5	40.00	361.50	461.5	70.0	DIN6535HB

**NEW****H8512****DORMER****Těleso vrtáku HYDRA 12xD s vnitřním chlazením, Povrchová úprava lesklé niklování**

Použití pro upnutí hlav HYDRA R950, R960 a R970. Několik velikostí hlav může být upínáno do téhož tělesa vrtáku. Vnitřní chlazení pro zlepšení chladicího efektu. Povrchová úprava lesklým niklováním brání korozi a zlepšuje odvod třísek.

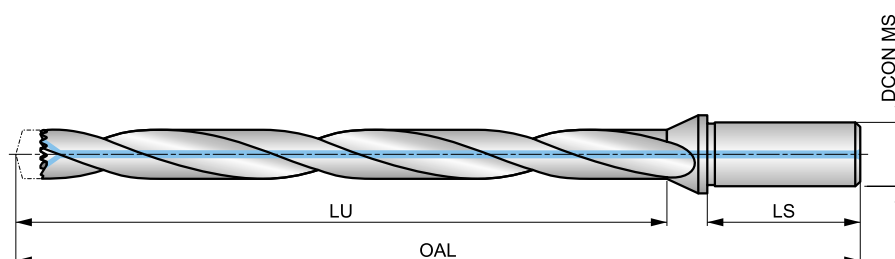
HYDRA

HSS	DORMER	12xD
Bright Ni		

Součástí balení jsou 4 ks šroubků a 1 ks šroubováku, DCON MS v toleranci h6.

Produkt	DCON MS (mm)	LU (mm)	OAL (mm)	LS (mm)
H851214.0	16.00	168.00	236.0	48.0
H851215.0	20.00	180.00	250.3	50.0
H851216.0	20.00	192.00	262.6	50.0
H851217.0	20.00	204.00	275.0	50.0
H851218.0	20.00	216.00	287.2	50.0
H851219.0	25.00	228.00	305.6	56.0
H851220.0	25.00	240.00	317.8	56.0
H851221.0	25.00	252.00	330.1	56.0
H851222.0	25.00	264.00	343.0	56.0
H851223.0	25.00	276.00	354.8	56.0
H851224.0	32.00	288.00	371.7	60.0
H851225.0	32.00	300.00	383.8	60.0



H860

Šrouby HYDRA

Upínací šrouby pro vrtací hlavy HYDRA



HYDRA

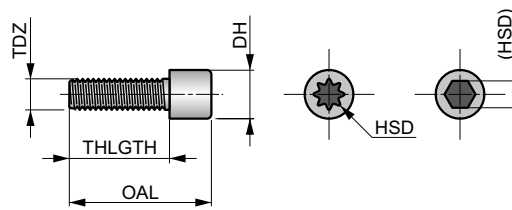

Produkt	Nr.	TDZ	OAL	THLGTH	DH	HSD
			(mm)	(mm)	(mm)	
H860N1	1	M2.2	7.5	5.70	3.5	8IP
H860N2	2	M2.5	9.0	7.00	4.1	10IP
H860N3	3	M3.0	10.5	8.00	4.9	15IP
H860N4	4	M3.5	11.5	8.80	5.5	15IP
H860N5	5	M4.0	12.5	9.50	6.0	20IP
H860N6	6	M4.5	14.3	10.80	6.8	25IP
H860N7	7	M5.0	20.0	15.00	8.5	4



H861



Šroubovák HYDRA

Šroubovák pro upínací šrouby HYDRA

HYDRA

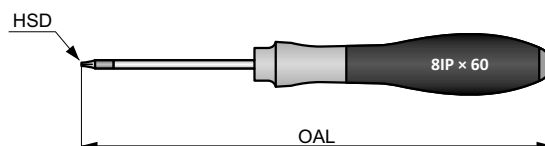

Produkt	Nr.	HSD	OAL
			(mm)
H861N1	N1	8IP	164.0
H861N2	N2	10IP	191.0
H861N3	N3	15IP	191.0
H861N4	N4	20IP	218.0
H861N5	N5	25IP	218.0
H861N6	N6	4	186.0



KOREKČNÍ FAKTORY ŘEZNÝCH PODMÍNEK (NA ZÁKLADĚ DÉLEK TĚLA HYDRA)

H851	Použijte počáteční hodnoty pro řeznou rychlost a posuv s korekčním faktorem 1,10
H853	Použijte počáteční hodnoty pro řeznou rychlost a posuv s korekčním faktorem 1,00
H855	Použijte počáteční hodnoty pro řeznou rychlost a posuv s korekčním faktorem 0,95
H858	Použijte počáteční hodnoty pro řeznou rychlost a posuv s korekčním faktorem 0,90
H8512	Použijte počáteční hodnoty pro řeznou rychlost a posuv s korekčním faktorem 0,80

The background of the page is a complex technical drawing or blueprint. It features a grid of lines, various geometric shapes such as hexagons, circles, and triangles, and arrows pointing in different directions. The drawing is rendered in shades of gray and white, with some elements highlighted in a light orange color. The overall appearance is that of a detailed engineering or architectural plan.

DESTIČKOVÉ VRTÁKY TECHNICKÉ INFORMACE



HYDRA – TECHNICKÉ INFORMACE

Tabulka krouticích momentů

H860	H861	Ø hlavy Hydra Metrický rozsah	Ø hlavy Hydra Rozsah ve zlomcích palců	Ø hlavy Hydra Rozsah v desetinných číslech (min./max.)	Hodnoty krouticího momentu Nm (metrický systém)	Hodnoty krouticího momentu in/lbs (palcový systém)
H860N1	H861N1	12.0 mm – 15.5 mm	15/32" – 39/64"	0.4688" – 0.6102"	0.75 – 0.99	6.6 – 8.8
H860N2	H861N2	15.6 mm – 18.5 mm	5/8" – 23/32"	0.6142" – 0.7283"	0.93 – 1.24	8.2 – 11.0
H860N3	H861N3	18.6 mm – 21.5 mm	47/64" – 27/32"	0.7323" – 0.8465"	1.84 – 2.44	16.3 – 21.6
H860N4	H861N3	22.0 mm – 24.5 mm	55/64" – 31/32"	0.8594" – 0.9688"	2.73 – 3.72	24.2 – 32.9
H860N5	H861N4	25.0 mm – 27.5 mm	63/64" – 1-3/32"	0.9843" – 1.0938"	4.14 – 5.52	36.6 – 48.8
H860N6	H861N5	28.0 mm – 33.5 mm	1-7/64" – 1-19/64"	1.1024" – 1.3189"	4.97 – 6.63	44.0 – 58.7
H860N7	H861N6	34.0 mm – 42.0 mm	1-11/32" – 1-5/8"	1.3386" – 1.6535"	7.2	63.7

Údaje pro šroubky a šroubovák

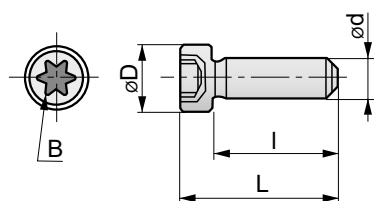

e kód	d	stoupání	L (mm)	l (mm)	D (mm)	B
H860N1	M2.2	0.45	7.5	5.7	3.5	8IP
H860N2	M2.5	0.45	9.0	7.0	4.1	10IP
H860N3	M3.0	0.50	10.5	8.0	4.9	15IP
H860N4	M3.5	0.60	11.5	8.8	5.5	15IP
H860N5	M4.0	0.70	12.5	9.5	6.0	20IP
H860N6	M4.5	0.75	14.3	10.8	6.8	25IP

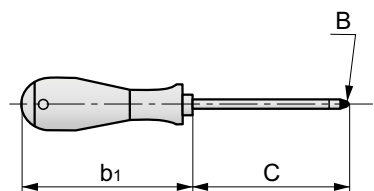

e kód	B	C	b ₁
H861N1	8IP	60	104
H861N2	10IP	80	111
H861N3	15IP	80	111
H861N4	20IP	100	118
H861N5	25IP	100	118

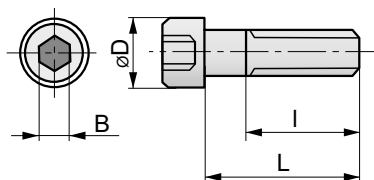

e kód	d	stoupání	L (mm)	l (mm)	D (mm)	B
H860N7	M5.0	0.8	15	full	8.5	4

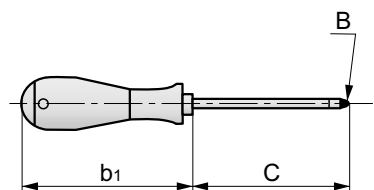

e kód	B	C	b ₁
H861N6	4	75	111



Pro vrtání $8 \times D$ a $12 \times D$ použijte speciální program

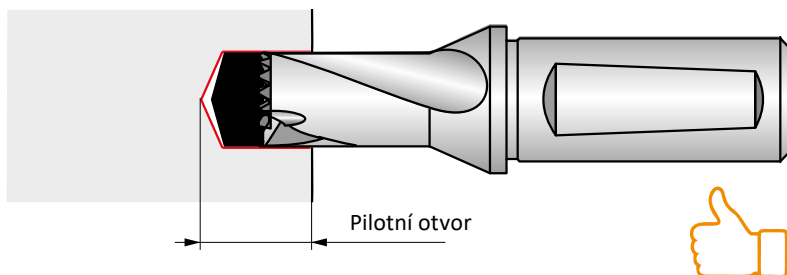

Vyvrtejte pilotní otvor (hloubka $1,5 \times D$ až $3 \times D$) stejným průměrem hlavy HYDRA (v případě potřeby zkontrolujte házení vrtáku max. $\pm 0,05$ mm).

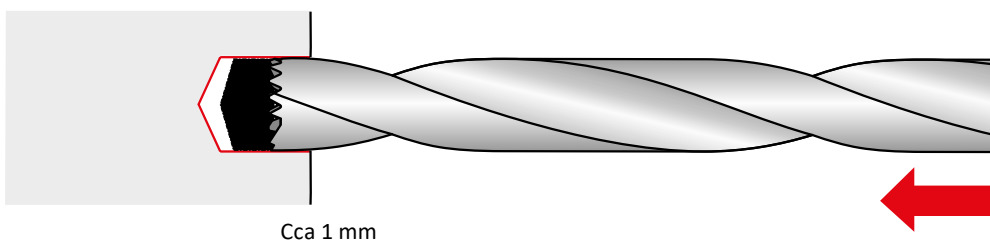

Vložte do pilotního otvoru vrták s tělem $8 \times D$ nebo $12 \times D$ při maximálních otáčkách 500 ot / min, do hloubky přibližně 1 mm nad dnem předvrtaného pilotního otvoru.

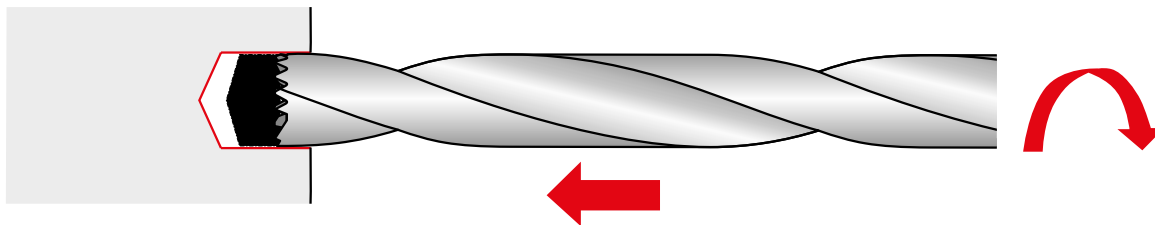

Spusťte průtok chladicí kapaliny a zvyšte rychlost otáček až na doporučené otáčky.

Pozn.: Použijte krátkou prodlevu, nezačínejte s posuvem, dokud nedosáhnete doporučených otáček.

Vyvrtejte bez přerušování do požadované hloubky.

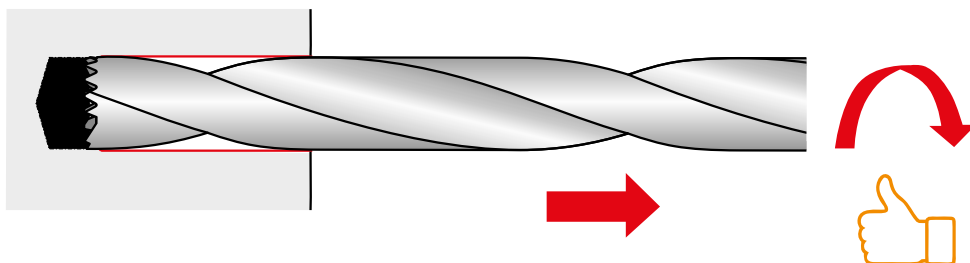

Po dosažení požadované hloubky vysuňte vrták přibližně o 0,1 mm až 0,5 mm a snižte otáčky na 500 ot / min, a poté úplně vysuňte s normálním posuvem. **Pozn.: Vysunutí vrtáku s vyšší rychlostí včetně může způsobit poškození ramene z důvodu házení nebo zničit povrch otvoru a toleranci.**

Rady a tipy pro vrtání pomocí vrtáku Hydra

Chladicí kapaliny

Pro maximální odvod třísek a výkon nástroje se doporučuje použití chladicí kapaliny. U většiny aplikací se doporučuje koncentrace chladicí emulze 6–8 % a tlak chladicí kapaliny 20 bar (290 PSI) nebo vyšší. Pro vysokopevnostní ocel, korozivzdorné oceli a aplikace náročnějšího vrtání použijte vyšší koncentraci 10–12 %. U těchto aplikací, zejména u nerezových ocelí, se doporučuje použít maximální dostupný tlak chladicí kapaliny na stroji. Otvory pro chladicí kapalinu u vrtáku Hydra poskytují vylepšenou pevnost jádra a snižují teplotu na řezných hranách, což zvyšuje produktivitu a prodlužuje životnost nástroje.

Upínače

Vždy používejte upínače nástrojů a kleštiny, které zajišťují dobrou

soustřednost mezi vrtákem a vřetenem stroje. Pomocí pozitivního dorazu zabraňte, aby se nástroj v upínači posunul zpět. Je třeba přesně zkontrolovat a udržovat radiální házení v sestavě nástroje.

Obrobek

Bezpečný a tuhý obrobek minimalizuje průhyb a umožní lepší přesnost a skutečnou polohu otvoru.

Posuvy

Je důležité, abyste nepoužívali nižší posuv, což by vedlo k prodlevám a otupení. Platí to zejména pro kalené materiály. Pro správnou tvorbu třísek by rychlost posuvu měla být dostatečně vysoká.

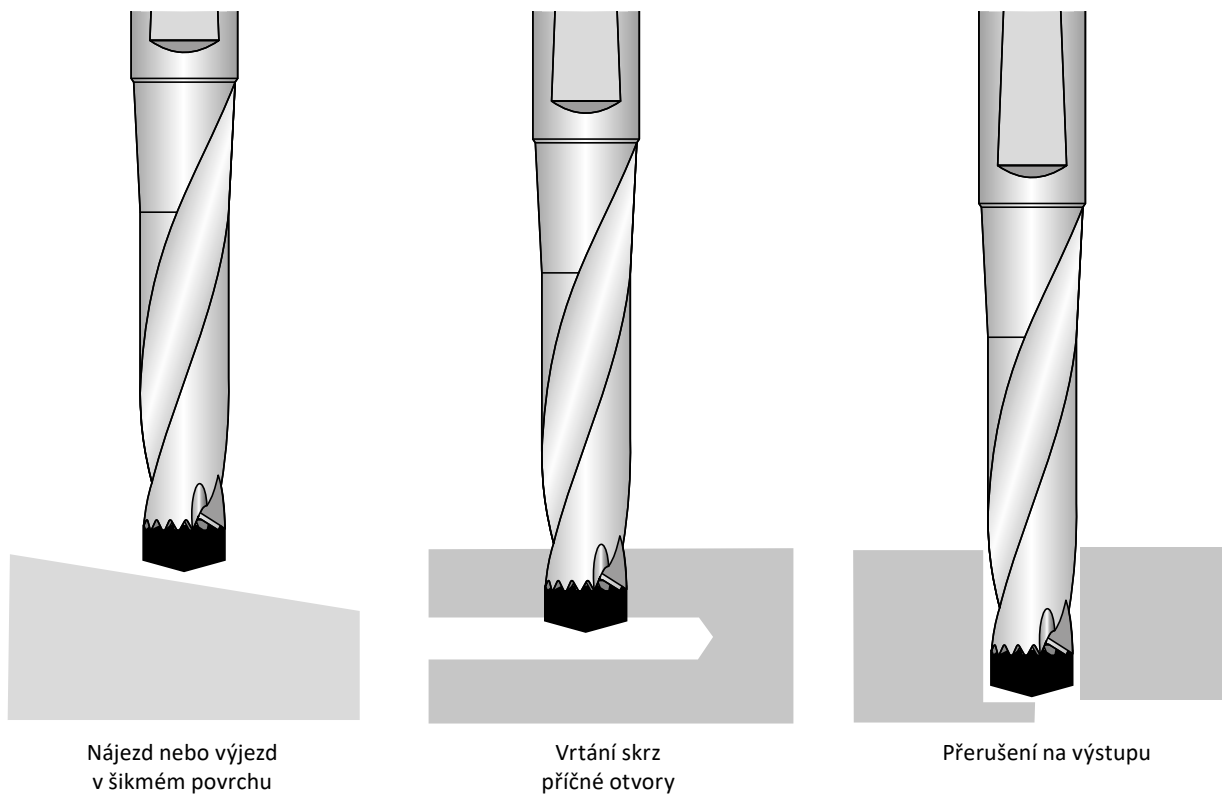

V těchto situacích vrtání se obecně doporučuje snížit rychlost posuvu na 1/3 (33 %). Vrtání do vstupního úhlu většího než 10° se NEDOPORUČUJE – povrch by měl být nejprve odfrézován do roviny.



VŠEOBECNÁ ČÁST – TECHNICKÉ INFORMACE

	Materiál	Tvrdość (HV10)	C %	W %	Mo %	Cr %	V %	Co %	Materiál nástroje
HSS	M2	810 – 850	0.9	6.4	5.0	4.2	1.8	–	HSS

Vlastnosti	HSS materiály	Karbidové materiály	K10/30F (často použito pro monolitní nástroje)
Tvrdość (HV30)	800 – 950	1300 – 1800	1600
Hustota (g/cm ³)	8.0 – 9.0	7.2 – 15	14.45
Pevność v tlaku (N/mm ²)	3000 – 4000	3000 – 8000	6250
Pevność v ohybu (N/mm ²)	2500 – 4000	1000 – 4700	4300
Tepelná odolność (°C)	550	1000	900
E modul (KN/mm ²)	260 – 300	460 – 630	580
Velikość zrna (µm)	–	0.2 – 10	0.8

Kombinace tvrdých částic (WC) a pojivového kovu (Co) poskytuje následující změny charakteristik.

Charakteristika	Vyšší obsah WC poskytuje	Vyšší obsah Co poskytuje
Tvrdość	Vyšší tvrdość	Nižší tvrdość
Pevność v tlaku (CS)	Vyšší CS	Nižší CS
Pevność v ohybu (BS)	Nižší BS	Vyšší BS

Vlastnosti materiálu také ovlivňují velikost zrna. Malé velikosti zrna znamenají vyšší tvrdość a hrubá zrna poskytují větší houževnatost.



VŠEOBECNÁ ČÁST – TECHNICKÉ INFORMACE

Průmyslové standardní tolerance pro hřídele a otvory

Hodnoty tolerance jsou uvedeny v mikrometrech (µm)

Přepočít pro mikrometry...1 µm = 0,001 mm / 0,000039"

Tolerance	Průměr (mm)							
	> 1 ≤ 3	> 3 ≤ 6	> 6 ≤ 10	> 10 ≤ 18	> 18 ≤ 30	> 30 ≤ 50	> 50 ≤ 80	> 80 ≤ 120
	Průměr (inch)							
	> 0.039" ≤ 0.118"	> 0.118" ≤ 0.236"	> 0.236" ≤ 0.394"	> 0.394" ≤ 0.709"	> 0.709" ≤ 1.181"	> 1.181" ≤ 1.968"	> 1.968" ≤ 3.149"	> 3.149" ≤ 4.724"
Hodnoty tolerance (µm)								
e8	-14 / -28	-20 / -38	-25 / -47	-32 / -59	-40 / -73	-50 / -89	-60 / -106	-72 / -126
f6	-6 / -12	-10 / -18	-13 / -22	-16 / -27	-20 / -33	-25 / -41	-30 / -49	-36 / -58
f7	-6 / -16	-10 / -22	-13 / -28	-16 / -34	-20 / -41	-25 / -50	-30 / -60	-36 / -71
h6	0 / -6	0 / -8	0 / -9	0 / -11	0 / -13	0 / -16	0 / -19	0 / -22
h7	0 / -10	0 / -12	0 / -15	0 / -18	0 / -21	0 / -25	0 / -30	0 / -35
h8	0 / -14	0 / -18	0 / -22	0 / -27	0 / -33	0 / -39	0 / -46	0 / -54
h9	0 / -25	0 / -30	0 / -36	0 / -43	0 / -52	0 / -62	0 / -74	0 / -87
h10	0 / -40	0 / -48	0 / -58	0 / -70	0 / -84	0 / -100	0 / -120	0 / -140
h11	0 / -60	0 / -75	0 / -90	0 / -110	0 / -130	0 / -160	0 / -190	0 / -220
h12	0 / -100	0 / -120	0 / -150	0 / -180	0 / -210	0 / -250	0 / -300	0 / -350
k10	+ 40 / 0	+ 48 / 0	+ 58 / 0	+ 70 / 0	+ 84 / 0	+ 100 / 0	+ 120 / 0	+ 140 / 0
k12	+ 100 / 0	+ 120 / 0	+ 150 / 0	+ 180 / 0	+ 210 / 0	+ 250 / 0	+ 300 / 0	+ 350 / 0
m7	+ 2 / + 12	+ 4 / + 16	+ 6 / + 21	+ 7 / + 25	+ 8 / + 29	+ 9 / + 34	+ 11 / + 41	+ 13 / + 48
js14	+ / -125	+ / -150	+ / -180	+ / -215	+ / -260	+ / -310	+ / -370	+ / -435
js16	+ / -300	+ / -375	+ / -450	+ / -550	+ / -650	+ / -800	+ / -950	+ / -1100
H7	+ 10 / 0	+ 12 / 0	+ 15 / 0	+ 18 / 0	+ 21 / 0	+ 25 / 0	+ 30 / 0	+ 35 / 0
H8	+ 14 / 0	+ 18 / 0	+ 22 / 0	+ 27 / 0	+ 33 / 0	+ 39 / 0	+ 46 / 0	+ 54 / 0
H9	+ 25 / 0	+ 30 / 0	+ 36 / 0	+ 43 / 0	+ 52 / 0	+ 62 / 0	+ 74 / 0	+ 87 / 0
H12	+ 100 / 0	+ 120 / 0	+ 150 / 0	+ 180 / 0	+ 210 / 0	+ 250 / 0	+ 300 / 0	+ 350 / 0
P9	-6 / -31	-12 / -42	-15 / -51	-18 / -61	-22 / -74	-26 / -86	-32 / -106	-37 / -124
S7	-13 / -22	-15 / -27	-17 / -32	-21 / -39	-27 / -48	-34 / -59	-42 / -72	-58 / -93



VŠEOBECNÁ ČÁST – TECHNICKÉ INFORMACE

Tabulka řezných rychlostí

		Vc															
m/min		5	8	10	15	20	25	30	40	50	60	70	80	90	100	110	150
SFM (feet/min.)		16	26	32	50	66	82	98	130	165	197	230	262	296	330	362	495
Ø		ot/min															
mm	inch																
1.00	–	1592	2546	3183	4775	6366	7958	9549	12732	15916	19099	22282	25465	28648	31831	35014	47747
1.50	–	1061	1698	2122	3183	4244	5305	6366	8488	10610	12732	14854	16977	19099	21221	23343	31831
2.00	–	796	1273	1592	2387	3183	3979	4775	6366	7958	9549	11141	12732	14324	15916	17507	23873
2.50	–	637	1019	1273	1910	2546	3183	3820	5093	6366	7639	8913	10186	11459	12732	14006	19099
3.00	–	531	849	1061	1592	2122	2653	3183	4244	5305	6366	7427	8488	9549	10610	11671	15916
3.18	1/8	500	801	1001	1501	2002	2502	3003	4004	5005	6006	7007	8008	9009	10010	11011	15015
3.50	–	455	728	909	1364	1819	2274	2728	3638	4547	5457	6366	7276	8185	9095	10004	13642
4.00	–	398	637	796	1194	1592	1989	2387	3183	3979	4775	5570	6366	7162	7958	8754	11937
4.50	–	354	566	707	1061	1415	1768	2122	2829	3537	4244	4951	5659	6366	7074	7781	10610
4.76	3/16	334	535	669	1003	1337	1672	2006	2675	3344	4012	4681	5350	6018	6687	7356	10031
5.00	–	318	509	637	955	1273	1592	1910	2546	3183	3820	4456	5093	5730	6366	7003	9549
6.00	–	265	424	531	796	1061	1326	1592	2122	2653	3183	3714	4244	4775	5305	5836	7958
6.35	1/4	251	401	501	752	1003	1253	1504	2005	2506	3008	3509	4010	4511	5013	5514	7519
7.00	–	227	364	455	682	909	1137	1364	1819	2274	2728	3183	3638	4093	4547	5002	6821
7.94	5/16	200	321	401	601	802	1002	1203	1604	2004	2405	2806	3207	3608	4009	4410	6013
8.00	–	199	318	398	597	796	995	1194	1592	1989	2387	2785	3183	3581	3979	4377	5968
9.00	–	177	283	354	531	707	884	1061	1415	1768	2122	2476	2829	3183	3537	3890	5305
9.53	3/8	167	267	334	501	668	835	1002	1336	1670	2004	2338	2672	3006	3340	3674	5010
10.00	–	159	255	318	477	637	796	955	1273	1592	1910	2228	2546	2865	3183	3501	4775
11.11	7/16	143	229	287	430	573	716	860	1146	1433	1719	2006	2292	2579	2865	3152	4298
12.00	–	133	212	265	398	531	663	796	1061	1326	1592	1857	2122	2387	2653	2918	3979
12.70	1/2	125	201	251	376	501	627	752	1003	1253	1504	1754	2005	2256	2506	2757	3760
14.00	–	114	182	227	341	455	568	682	909	1137	1364	1592	1819	2046	2274	2501	3410
14.29	9/16	111	178	223	334	446	557	668	891	1114	1337	1559	1782	2005	2228	2450	3341
15.00	–	106	170	212	318	424	531	637	849	1061	1273	1485	1698	1910	2122	2334	3183
15.88	5/8	100	160	200	301	401	501	601	802	1002	1203	1403	1604	1804	2004	2205	3007
16.00	–	99	159	199	298	398	497	597	796	995	1194	1393	1592	1790	1989	2188	2984
17.46	11/16	91	146	182	273	365	456	547	729	912	1094	1276	1458	1641	1823	2005	2735
18.00	–	88	141	177	265	354	442	531	707	884	1061	1238	1415	1592	1768	1945	2653
19.05	3/4	84	134	167	251	334	418	501	668	835	1003	1170	1337	1504	1671	1838	2506
20.00	–	80	127	159	239	318	398	477	637	796	955	1114	1273	1432	1592	1751	2387
24.00	–	66	106	133	199	265	332	398	531	663	796	928	1061	1194	1326	1459	1989
25.00	–	64	102	127	191	255	318	382	509	637	764	891	1019	1146	1273	1401	1910
27.00	–	59	94	118	177	236	295	354	472	589	707	825	943	1061	1179	1297	1768
30.00	–	53	85	106	159	212	265	318	424	531	637	743	849	955	1061	1167	1592
32.00	–	50	80	99	149	199	249	298	398	497	597	696	796	895	995	1094	1492
36.00	–	44	71	88	133	177	221	265	354	442	531	619	707	796	884	973	1326
40.00	–	40	64	80	119	159	199	239	318	398	477	557	637	716	796	875	1194
50.00	–	32	51	64	95	127	159	191	255	318	382	446	509	573	637	700	955



VŠEOBECNÁ ČÁST – TECHNICKÉ INFORMACE

Tvrdość a pevnost v tahu

HV	HRC	HB	Pevnost v tahu	
			N/mm ²	Tons /sq. in.
Vickers	Rockwell	Brinell		
940	68	–	–	–
900	67	–	–	–
864	66	–	–	–
829	65	–	–	–
800	64	–	–	–
773	63	–	–	–
745	62	–	–	–
720	61	–	–	–
698	60	–	–	–
675	59	–	–	–
655	58	–	2200	142
650	–	618	2180	141
640	–	608	2145	139
639	57	607	2140	138
630	–	599	2105	136
620	–	589	2070	134
615	56	584	2050	133
610	–	580	2030	131
600	–	570	1995	129
596	55	567	1980	128
590	–	561	1955	126
580	–	551	1920	124
578	54	549	1910	124
570	–	542	1880	122
560	53	532	1845	119
550	–	523	1810	117
544	52	517	1790	116
540	–	513	1775	115
530	–	504	1740	113
527	51	501	1730	112
520	–	494	1700	110
514	50	488	1680	109
510	–	485	1665	108
500	–	475	1630	105
497	49	472	1620	105
490	–	466	1595	103
484	48	460	1570	102
480	–	456	1555	101
473	47	449	1530	99
470	–	447	1520	98
460	–	437	1485	96
458	46	435	1480	96
450	–	428	1455	94
446	45	424	1440	93
440	–	418	1420	92

HV	HRC	HB	Pevnost v tahu	
			N/mm ²	Tons /sq. in.
Vickers	Rockwell	Brinell		
434	44	413	1400	91
423	43	402	1360	88
413	42	393	1330	86
403	41	383	1300	84
392	40	372	1260	82
382	39	363	1230	80
373	38	354	1200	78
364	37	346	1170	76
355	36	337	1140	74
350	–	333	1125	73
345	35	328	1110	72
340	–	323	1095	71
336	34	319	1080	70
330	–	314	1060	69
327	33	311	1050	68
320	–	304	1030	67
317	32	301	1020	66
310	31	295	995	64
302	30	287	970	63
300	–	285	965	62
295	–	280	950	61
293	29	278	940	61
290	–	276	930	60
287	28	273	920	60
285	–	271	915	59
280	27	266	900	58
275	–	261	880	57
272	26	258	870	56
270	–	257	865	56
268	25	255	860	56
265	–	252	850	55
260	24	247	835	54
255	23	242	820	53
250	22	238	800	52
245	–	233	785	51
243	21	231	780	50
240	–	228	770	50
235	–	223	755	49
230	–	219	740	48
225	–	214	720	47
220	–	209	705	46
215	–	204	690	45
210	–	199	675	44
205	–	195	660	43
200	–	190	640	41



DORMER PRAMET



RYCHLÉ VYHLEDÁNÍ

Prostřednictvím naší knihovny si snadno a rychle provedete textové vyhledávání v jakékoli literatuře publikované v nedávné době společností Dormer Pramet. Stáhněte si ji ještě dnes z Vašeho příslušného App Store. **Jsme jednoduše spolehliví.**





DESTIČKOVÉ VRTÁKY



PŘEHLED VRTÁKŮ S DESTIČKAMI

Pracovní délka	2×D	3×D	4×D	5×D	XPET..AP	SCET..UD	XPET..AP-SD	SCET..-SD
Obrázek								
Chlazení					-	-	-	-
	313	315	318	320	324	323	324	323
Typ vrtáku vrtáku	802D	803D	804D	805D	-	-	-	-
Tolerance vrtáku	± 0.05	± 0.05	± 0.05	± 0.05	-	-	-	-
Tolerance otvoru	0/+0.2	0/+0.3	0/+0.4	0/+0.5	-	-	-	-
Dosahovaná drsnost povrchu *	R _a 2–6 μm	R _a 2–6 μm	R _a 2–6 μm	R _a 2–6 μm	-	-	-	-
Rozsah průměrů	15.0–40.0	15.0–58.0	17.0–58.0	19.0–31.0	-	-	-	-
Oblasti použití	P1	■	■	■	■	■	■	■
	P2	■	■	■	■	■	■	■
	P3	■	■	■	■	■	■	■
	P4	■	■	■	■	■	■	■
	M1						■	■
	M2						■	■
	M3						■	■
	M4						■	■
	K1	☑	■	☑	☑	☑	☑	☑
	K2	☑	■	☑	☑	☑	☑	☑
	K3	☑	■	☑	☑	☑	☑	☑
	K4	☑	■	☑	☑	☑	☑	☑
	K5	☑	■	☑	☑	☑	☑	☑
	S1						☑	☑
	S2						☑	☑
	S3						☑	☑
S4						☑	☑	

* Tolerance vrtaného otvoru a jakost povrchu jsou značně závislé na obráběcích podmínkách.



DESTIČKOVÉ VRTÁKY – NAVIGÁTOR MATERIÁLY DESTIČEK

Označení materiálu	Aplikační oblast	Použití	Posuv	Řezná rychlost	Odolnost vůči nepříznivým pracovním podmínkám	Povlak	Barva	Substrát	Výhoda chlazení	Popis materiálu
D9335	P20 - P35	■				MT-CVD	■	FGM	+++	Tento materiál se doporučuje u destičkových vrtáků, je vhodnější pro vyšší řezné rychlosti a posuvy.
	M15 - M30	■								
	K15 - K35	■								
	S10 - S20	■								
D8330	P20 - P35	■				PVD	■	submicron H	+++	Jedná se o univerzální materiál pro vnější destičku do destičkových vrtáků, lze ho použít pro většinu materiálů a vyniká provozní spolehlivostí.
	M15 - M30	■								
	K15 - K35	■								
	S10 - S20	■								
D8345	P30 - P50	■				PVD	■	submicron H	+++	Tento materiál je univerzální pro centrální destičku u destičkových vrtáků, je extrémně odolný pro většinu materiálů obrobků.
	M20 - M40	■								
	K30 - K40	■								
	S20 - S30	■								

Substrát

submicron H	Substrát na bázi WC-Co (< 1 mm)
FGM	Funkčněgradientní substrát

Povlak

MT-CVD	Středně teplotní chemická metoda povlakování
PVD	Nízkoteplotní fyzikální metoda povlakování

Přínos použití chlazení

+++	Použití chlazení je základ
-----	----------------------------



VYMĚNITELNÉ BŘITOVÉ DESTIČKY – ISO SYSTÉM ZNAČENÍ

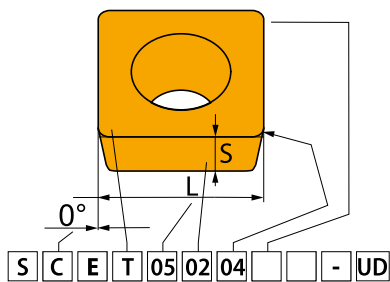

ISO	1	2	3	4
	S	C	E	T
ANSI	1	2	3	4
	S	C	E	T

1				2				4														
Tvar destičky				Úhel hřbetu destičky				Provedení destičky														
H	O	P	R	A	B	C	D	N	R	F	A	M	G	W	T	Q	U	B	H	C	J	X
S	T	C	D	E	F	G	N	O	Speciální													
E	M	V	W																			
L	A	B	K																			

3									
Tolerance									
	(mm)			(")					
	M(±)	S(±)	IC(±)	M(±)	S(±)	IC(±)			
A	0.005	0.025	0.025	.0002"	.001"	.0010"			
F	0.005	0.025	0.013	.0002"	.001"	.0005"			
C	0.013	0.025	0.025	.0005"	.001"	.0010"			
H	0.013	0.025	0.013	.0005"	.001"	.0005"			
E	0.025	0.025	0.025	.0010"	.001"	.0010"			
G	0.025	0.130	0.025	.0010"	.005"	.0010"			
J	0.005	0.025	0.05 – 0.13	.0002"	.001"	.002 – 0.005"			
K	0.013	0.025	0.05 – 0.13	.0005"	.001"	.002 – 0.005"			
L	0.025	0.025	0.05 – 0.13	.0010"	.001"	.002 – 0.005"			
M	0.08 – 0.18	0.130	0.05 – 0.13	.003 – 0.007"	.005"	.002 – 0.005"			
N	0.08 – 0.18	0.025	0.05 – 0.13	.003 – 0.007"	.001"	.002 – 0.005"			
U	0.05 – 0.38	0.130	0.05 – 0.13	.005 – 0.015"	.005"	.003 – 0.010"			

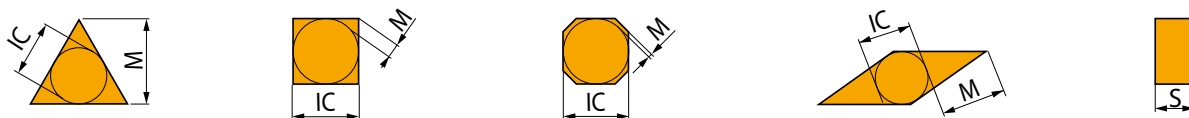



VYMĚNITELNÉ BŘITOVÉ DESTIČKY – ISO SYSTÉM ZNAČENÍ

5	6	7	8	9	10
05	02	04			UD
5	6	7	8	9	10
1.8	1.5	1			UD

5		5												
Délka řezné hrany (velikost) destičky														
d = IC		H	O	P	S	T	C	D	E	M	V	W	R	K
(mm)	(in)													
3.97	5/32"				03	06		04			06	02		
4.76	3/16"				04	08	04	05	04	04	08	L3		
5.56	7/32"				05	09	05	06	05	05	09	03		
6.35	1/4"	03	02	04	08	11	06	07	08	08	11	04	06	
7.94	5/16"	04	03	05	07	13	08	09	06	07	13	05	07	
9.525	3/8"	05	04	07	09	16	09	11	09	09	16	06	09	16
12.7	1/2"	07	05	09	12	22	12	15	13	12	22	08	12	
15.875	5/8"	09	06	11	15	27	16	19	16	15	27	10	15	
19.05	3/4"	11	07	13	19	33	19	23	19	19	33	13	19	
25.40	1"	14	10	18	25	44	25	31	26	25	44	17	25	
31.75	1 1/4"	18	13	23	31	54	32	38	32	31	54	21	31	

6		7	
Tloušťka destičky		Rádus špičky destičky	
		RE	
		(mm)	(")
01	1.59	0	0"
T1	1.98	0.2	1/128"
02	2.38	0.4	1/64"
03	3.18	0.8	1/32"
T3	3.97	1.2	3/64"
04	4.76	1.6	1/16"
05	5.56	2.4	3/32"
06	6.35	3.2	1/8"
07	7.94		
09	9.52		

6		7	
Tloušťka destičky		Rádus špičky destičky	
		Kruhové destičky	
		d = I.C.	
		(")	00
		(mm)	M0

ANSI					
5		6		7	
Vepsaná kružnice		Tloušťka destičky		Rádus špičky destičky	
Symbol	d = I.C.	Symbol	S	Symbol	RE
	(mm)		(mm)		(mm)
	(")		(")		(")
1	3.175	1	1.588	0	0
	1/8"		1/16"	0.2	0.099
1.2	3.969	1.2	1.984		1/256"
	5/32"		5/64"	0.5	0.198
1.5	4.763	1.5	2.381	1	0.397
	3/16"		3/32"		1/128"
1.8	5.556	2	3.175	2	0.794
	7/32"		1/8"		1/32"
2	6.350	2.5	3.969	3	1.191
	1/4"		5/32"		3/64"
2.5	7.938	3	4.763	4	1.588
	5/16"		3/16"		1/16"
3	9.525	3.5	5.556	5	1.984
	3/8"		7/32"		5/64"
4	12.700	4	6.350	6	2.381
	1/2"		1/4"		3/32"
5	15.875	5	7.938	7	2.778
	5/8"		5/16"		7/64"
6	19.050	6	9.525	8	3.175
	3/4"		3/8"		1/8"
7	22.225	7	11.113	10	3.969
	7/8"		7/16"		5/32"
8	25.400	8	12.700	12	4.763
	1"		1/2"		3/16"
10	31.750	9	14.288	14	5.556
	5/4"		9/16"		7/32"
12	38.100	10	15.875	16	6.350
	6/4"		5/8"		1/4"

8		8	
Provedení řezné hrany destičky			
	Ostré hrany		Zaoblené hrany
	Hrany s fazetkou		Zaoblené hrany s fazetkou
	Hrany s dvojitou fazetkou		Zaoblené hrany s dvojitou fazetkou
9		9	
Směr posuvu			
R		N	
L			
10		10	
Utvařec			



ZNAČENÍ VRTÁKŮ

1	2	3		4		5		6	7
8	05	D	-	19	-	95	-	S	25

*Značení platí pro typy vyrobené od roku 2011



Destičkový vrták *

1		2		3		4	
Druh nástroje		Pracovní délka		Provedení		Řezný průměr	
8	Destičkový vrták	02	2 × DC	D	Vrták	15.5	DC = 15.5 mm
		03	3 × DC				19
		04	4 × DC				
		05	5 × DC				
5		6		7			
Max. hloubka vrtání		Typ stopky		Průměr stopky			
35	35 mm	E	Whistle Notch	25	D CON MS = 25 mm		
95	95 mm			32	D CON MS = 32 mm		
140	140 mm	S	ISO 9766	40	D CON MS = 40 mm		



802D

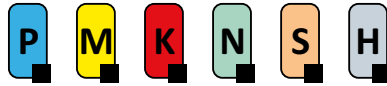

PRAMET

S



2xD 802D Vrták s destičkami a vnitřním chlazením

Vysoce výkonný vrták s destičkami pro vrtání slepých a průchozých otvorů. Také může být potenciálně použit pro křížení otvorů, vrtání mimo osu, spirálovou interpolaci, zajištění pod úhlem, vrtání do vypouklých a šikmých ploch, vrtání v přerušovaném řezu, srážení úkosů a vyvrtávání. Dostupný v Ø15 - Ø40 mm a délce 2xD.

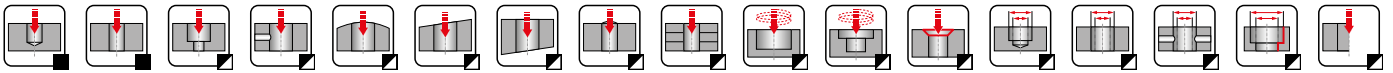
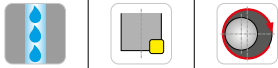
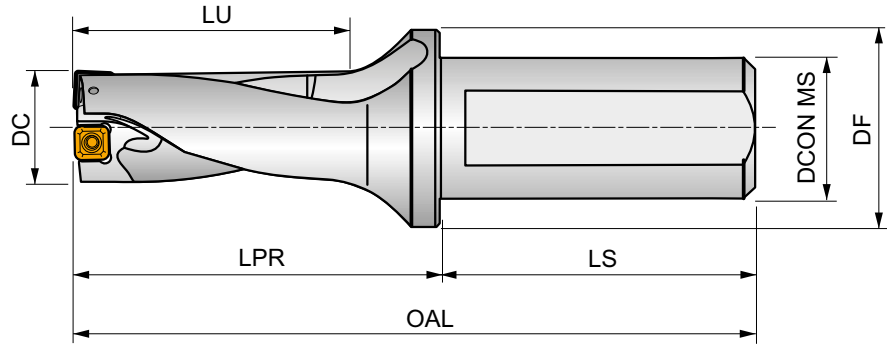

Produkt	DC	APMX	OAL	LPR	LS	LU	DCON MS	DF	$\overset{-}{D}$	$\overset{+}{D}$	G1300	G1313	G1314	kg	HM001
	(mm)	(mm)	(mm)	(mm)	(mm)	(mm)		(mm)	(mm)	(mm)					
802D-15-30-S25	15	30.00	121	65	56	34.5	25	35	0.25	0.35	EP253253	GI300	GI313	0.30	HM001
802D-16-32-S25	16	32.00	123	67	56	37	25	35	0.15	0.45	EP253253	GI300	GI313	0.30	HM001
802D-17-34-S25	17	34.00	125	69	56	39.5	25	35	0.10	0.50	EP253253	GI300	GI313	0.31	HM001
802D-18-36-S25	18	36.00	127	71	56	42	25	35	0.35	0.25	EP253253	GI301	GI314	0.31	HM002
802D-19-38-S25	19	38.00	129	73	56	44.5	25	35	0.15	0.45	EP253253	GI301	GI314	0.32	HM002
802D-20-40-S25	20	40.00	131	75	56	47	25	35	0.10	0.45	EP253253	GI302	GI315	0.33	HM003
802D-21-42-S25	21	42.00	133	77	56	49.5	25	35	0.10	0.50	EP253253	GI302	GI315	0.34	HM003
802D-22-44-S25	22	44.00	135	79	56	52	25	35	0.45	0.50	EP253253	GI303	GI316	0.35	HM004
802D-23-46-S25	23	46.00	137	81	56	54.5	25	35	0.35	0.50	EP253253	GI304	GI317	0.36	HM005
802D-24-48-S25	24	48.00	139	83	56	57	25	35	0.15	0.50	EP253253	GI304	GI317	0.37	HM005
802D-25-50-S32	25	50.00	145	85	60	57	32	42	0.15	0.50	EP324058	GI304	GI317	0.57	HM005
802D-26-52-S32	26	52.00	147	87	60	59.5	32	42	0.10	0.50	EP324058	GI304	GI317	0.58	HM005
802D-27-54-S32	27	54.00	149	89	60	62	32	42	0.50	0.30	EP324058	GI305	GI318	0.59	HM006
802D-28-56-S32	28	56.00	151	91	60	64.5	32	42	0.30	0.50	EP324058	GI306	GI319	0.61	HM007
802D-29-58-S32	29	58.00	153	93	60	67	32	42	0.20	0.50	EP324058	GI306	GI319	0.62	HM007
802D-30-60-S32	30	60.00	155	95	60	69.5	32	42	0.15	0.50	EP324058	GI306	GI319	0.67	HM007
802D-32-64-S32	32	64.00	159	99	60	70	32	42	0.50	0.35	EP324058	GI307	GI320	0.68	HM008
802D-32-64-S40	32	64.00	167	99	68	70	40	50	0.50	0.35	-	GI307	GI320	1.03	HM008
802D-34-68-S32	34	68.00	163	103	60	75	32	42	0.25	0.50	EP324058	GI307	GI320	0.73	HM008
802D-34-68-S40	34	68.00	171	103	68	75	40	50	0.25	0.50	-	GI307	GI320	1.07	HM008
802D-36-72-S32	36	72.00	167	107	60	80	32	42	0.10	0.50	EP324058	GI308	GI321	0.76	HM009
802D-36-72-S40	36	72.00	173	105	68	77.5	40	50	0.10	0.50	-	GI308	GI321	1.11	HM009
802D-38-76-S32	38	76.00	171	111	60	85	32	42	0.50	0.50	EP324058	GI308	GI321	0.83	HM009
802D-38-76-S40	38	76.00	179	111	68	85	40	50	0.50	0.50	-	GI308	GI321	1.17	HM009
802D-40-80-S32	40	80.00	175	115	60	90	32	42	0.20	0.50	EP324058	GI309	GI322	0.91	HM009
802D-40-80-S40	40	80.00	183	115	68	90	40	50	0.20	0.50	-	GI309	GI322	1.25	HM009



GI300	XPET 0502AP	SCET 050204-UD
GI301	XPET 0602AP	SCET 050204-UD
GI302	XPET 0602AP	SCET 060204-UD
GI303	XPET 0703AP	SCET 060204-UD
GI304	XPET 0703AP	SCET 070308-UD
GI305	XPET 0903AP	SCET 070308-UD
GI306	XPET 0903AP	SCET 09T308-UD
GI307	XPET 11T3AP	SCET 09T308-UD
GI308	XPET 11T3AP	SCET 120408-UD
GI309	XPET 12T3AP	SCET 120408-UD
GI313	XPET 0502AP-SD	SCET 050204-SD
GI314	XPET 0602AP-SD	SCET 050204-SD
GI315	XPET 0602AP-SD	SCET 060204-SD
GI316	XPET 0703AP-SD	SCET 060204-SD
GI317	XPET 0703AP-SD	SCET 070308-SD
GI318	XPET 0903AP-SD	SCET 070308-SD
GI319	XPET 0903AP-SD	SCET 09T308-SD
GI320	XPET 11T3AP-SD	SCET 09T308-SD
GI321	XPET 11T3AP-SD	SCET 120408-SD
GI322	XPET 12T3AP-SD	SCET 120408-SD

HM001	US 2245-T07P	0.9	US 2245-T07P	0.9	FLAG T07P
HM002	US 2205-T07P	0.9	US 2245-T07P	0.9	FLAG T07P
HM003	US 2205-T07P	0.9	US 2205-T07P	0.9	FLAG T07P
HM004	US 2506-T07P	1.2	US 2506-T07P	1.2	FLAG T07P
HM005	US 2507-T08P	1.2	US 3007-T08P	2.0	FLAG T08P
HM006	US 3007-T09P	2.0	US 3007-T09P	2.0	FLAG T09P
HM007	US 3007-T09P	2.0	US 3009-T09P	2.0	FLAG T09P
HM008	US 3510-T15P	3.0	US 3508-T15P	3.0	FLAG T15P
HM009	US 3510-T15P	3.0	US 5012-T15P	5.0	FLAG T15P

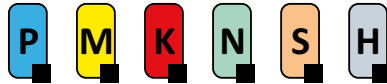
**803D**

PRAMET

S**3xD 803D Vrták s destičkami a vnitřním chlazením**

Vysoce výkonný vrták s destičkami pro vrtání slepých a průchozích otvorů. Také může být potenciálně použit pro křížení otvorů, vrtání mimo osu, spirálovou interpolaci, zajištění pod úhlem, vrtání do vypouklých a šikmých ploch, vrtání v perušovaném řezu, srážení úkosů a vyvrtávání. Dostupný v Ø15 - Ø58 mm a délce 3xD.

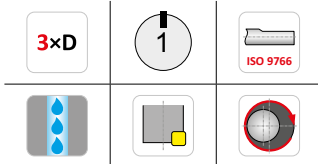
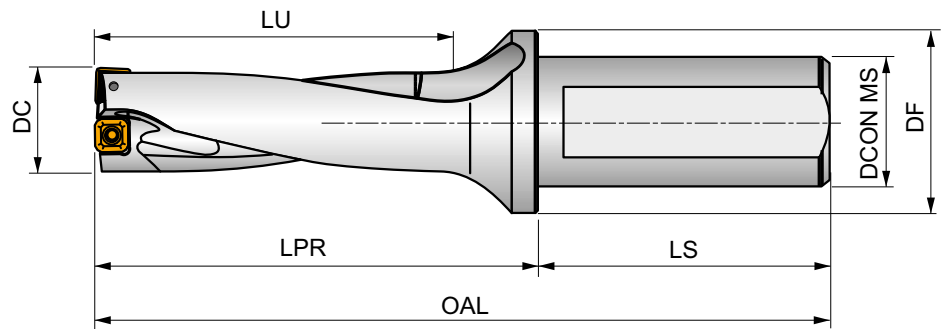

Produkt	DC	APMX	OAL	LPR	LS	LU	DCON MS	DF	\bar{D}	\bar{D}^+					
	(mm)	(mm)	(mm)	(mm)	(mm)	(mm)		(mm)	(mm)	(mm)					
803D-15-45-S25	15	45.00	136	80	56	49.5	25	35	0.25	0.35	EP253253	GI300	GI313	0.31	HM001
803D-15,5-46,5-S25	15.5	47.00	137.5	81.5	56	51.2	25	35	0.30	0.35	EP253253	GI300	GI313	0.31	HM001
803D-16-48-S25	16	48.00	139	83	56	53	25	35	0.15	0.45	EP253253	GI300	GI313	0.32	HM001
803D-16,5-49,5-S25	16.5	50.00	140.5	84.5	56	54.7	25	35	0.15	0.40	EP253253	GI300	GI313	0.32	HM001
803D-17-51-S25	17	51.00	142	86	56	56.5	25	35	0.10	0.50	EP253253	GI300	GI313	0.32	HM001
803D-17,5-52,5-S25	17.5	53.00	143.5	87.5	56	58.2	25	35	0.50	0.50	EP253253	GI301	GI314	0.32	HM002
803D-18-54-S25	18	54.00	145	89	56	60	25	35	0.35	0.25	EP253253	GI301	GI314	0.33	HM002
803D-18,5-55,5-S25	18.5	56.00	146.5	90.5	56	61.2	25	35	0.35	0.25	EP253253	GI301	GI314	0.34	HM002
803D-19-57-S25	19	57.00	148	92	56	63.5	25	35	0.15	0.45	EP253253	GI301	GI314	0.34	HM002
803D-19,5-58,5-S25	19.5	59.00	149.5	93.5	56	63.7	25	35	0.25	0.40	EP253253	GI302	GI315	0.34	HM003
803D-20-60-S25	20	60.00	151	95	56	67	25	35	0.10	0.45	EP253253	GI302	GI315	0.35	HM003
803D-20,5-61,5-S25	20.5	62.00	152.5	96.5	56	67.2	25	35	0.10	0.50	EP253253	GI302	GI315	0.36	HM003
803D-21-63-S25	21	63.00	154	98	56	70.5	25	35	0.10	0.50	EP253253	GI302	GI315	0.36	HM003
803D-21,5-64,5-S25	21.5	65.00	155.5	99.5	56	70.8	25	35	0.35	0.50	EP253253	GI303	GI316	0.37	HM004
803D-22-66-S25	22	66.00	157	101	56	74	25	35	0.45	0.50	EP253253	GI303	GI316	0.38	HM004
803D-22,5-67,5-S25	22.5	68.00	158.5	102.5	56	74.3	25	35	0.35	0.50	EP253253	GI304	GI317	0.39	HM005
803D-23-69-S25	23	69.00	160	104	56	77.5	25	35	0.35	0.50	EP253253	GI304	GI317	0.40	HM005
803D-23,5-70,5-S25	23.5	71.00	161.5	105.5	56	77.6	25	35	0.10	0.50	EP253253	GI304	GI317	0.40	HM005
803D-24-72-S25	24	72.00	163	107	56	81	25	35	0.15	0.50	EP253253	GI304	GI317	0.41	HM005
803D-24,5-73,5-S25	24.5	74.00	168.5	108.5	60	78.7	25	35	0.10	0.50	EP253253	GI304	GI317	0.42	HM005
803D-25-75-S32	25	75.00	170	110	60	82	32	42	0.15	0.50	EP324058	GI304	GI317	0.62	HM005
803D-25,5-76,5-S32	25.5	77.00	171.5	111.5	60	82.2	32	42	0.50	0.10	EP324058	GI304	GI317	0.63	HM005
803D-26-78-S32	26	78.00	173	113	60	85.5	32	42	0.10	0.50	EP324058	GI304	GI317	0.64	HM005
803D-26,5-79,5-S32	26.5	80.00	174.5	114.5	60	85.7	32	42	0.50	0.10	EP324058	GI305	GI318	0.65	HM006
803D-27-81-S32	27	81.00	176	116	60	89	32	42	0.50	0.30	EP324058	GI305	GI318	0.65	HM006
803D-28-84-S32	28	84.00	179	119	60	92.5	32	42	0.30	0.50	EP324058	GI306	GI319	0.68	HM007
803D-29-87-S32	29	87.00	182	122	60	96	32	42	0.20	0.50	EP324058	GI306	GI319	0.70	HM007



Produkt	DC	APMX	OAL	LPR	LS	LU	DCONIMS	DF	$\overset{-}{D}$	$\overset{+}{D}$					
	(mm)	(mm)	(mm)	(mm)	(mm)	(mm)	(mm)	(mm)	(mm)	(mm)					
803D-30-90-S32	30	90.00	185	125	60	99.5	32	42	0.15	0.50	EP324058	GI306	GI319	0.73	HM007
803D-31-93-S32	31	93.00	188	128	60	103	32	42	0.15	0.50	EP324058	GI306	GI319	0.76	HM007
803D-32-96-S32	32	96.00	191	131	60	102	32	42	0.50	0.30	EP324058	GI307	GI320	0.79	HM008
803D-32-96-S40	32	96.00	199	131	68	102	40	50	0.50	0.30	–	GI307	GI320	1.14	HM008
803D-33-99-S32	33	99.00	194	134	60	105.5	32	42	0.50	0.50	EP324058	GI307	GI320	0.83	HM008
803D-33-99-S40	33	99.00	202	134	68	105.5	40	50	0.50	0.50	–	GI307	GI320	1.18	HM008
803D-34-102-S32	34	102.00	197	137	60	109	32	42	0.25	0.50	EP324058	GI307	GI320	0.86	HM008
803D-34-102-S40	34	102.00	205	137	68	109	40	50	0.25	0.50	–	GI307	GI320	1.12	HM008
803D-35-105-S32	35	105.00	200	140	60	112.5	32	42	0.25	0.50	EP324058	GI308	GI321	0.90	HM009
803D-35-105-S40	35	105.00	208	140	68	112.5	40	50	0.25	0.50	–	GI308	GI321	1.24	HM009
803D-36-108-S32	36	108.00	203	143	60	116	32	42	0.10	0.50	EP324058	GI308	GI321	0.91	HM009
803D-36-108-S40	36	108.00	211	143	68	116	40	50	0.10	0.50	–	GI308	GI321	1.25	HM009
803D-37-111-S32	37	111.00	206	146	60	119.5	32	42	0.10	0.50	EP324058	GI308	GI321	0.95	HM009
803D-37-111-S40	37	111.00	214	146	68	119.5	40	50	0.10	0.50	–	GI308	GI321	1.29	HM009
803D-38-114-S32	38	114.00	199	139	60	124.5	32	42	0.50	0.50	EP324058	GI308	GI321	1.00	HM009
803D-38-114-S40	38	114.00	217	149	68	123	40	50	0.50	0.50	–	GI308	GI321	1.34	HM009
803D-39-117-S32	38	114.00	209	149	60	123	32	42	0.40	0.50	EP324058	GI309	GI322	1.06	HM009
803D-39-117-S40	39	117.00	220	152	68	126.5	40	50	0.40	0.50	–	GI309	GI322	1.40	HM009
803D-40-120-S32	40	120.00	215	155	60	130	32	42	0.20	0.50	EP324058	GI309	GI322	1.12	HM009
803D-40-120-S40	40	120.00	223	155	68	130	40	50	0.20	0.50	–	GI309	GI322	1.46	HM009
803D-41-123-S40	41	123.00	219	149	70	133	40	50	0.20	0.50	–	GI309	GI322	1.48	HM009
803D-42-126-S40	42	126.00	221.5	152	70	136	40	50	0.15	0.50	–	GI309	GI322	1.52	HM009
803D-43-129-S40	43	129.00	224	154	70	139	40	50	0.10	0.50	–	GI309	GI322	1.58	HM009
803D-44-132-S40	44	132.00	226.5	157	70	142	40	50	0.50	0.50	–	GI310	GI323	1.63	HM010
803D-45-135-S40	45	135.00	230.5	161	70	144	40	55	0.50	0.50	–	GI311	GI324	1.73	HM010
803D-46-138-S40	46	138.00	235	165	70	148	40	55	0.50	0.50	–	GI311	GI324	1.82	HM010
803D-47-141-S40	47	141.00	237.5	168	70	151	40	55	0.50	0.50	–	GI311	GI324	1.90	HM010
803D-48-144-S40	48	144.00	240	170	70	154	40	55	0.50	0.50	–	GI311	GI324	1.98	HM010
803D-49-147-S40	49	147.00	242.5	173	70	157	40	55	0.30	0.50	–	GI311	GI324	2.06	HM010
803D-50-150-S40	50	150.00	246.5	177	70	160	40	58	0.15	0.50	–	GI311	GI324	2.18	HM010
803D-51-153-S40	51	153.00	249	179	70	163	40	58	0.15	0.50	–	GI311	GI324	2.24	HM010
803D-52-156-S40	52	156.00	251.5	182	70	166	40	58	0.50	0.50	–	GI312	GI325	2.20	HM010
803D-53-159-S40	53	159.00	254	184	70	169	40	58	0.50	0.50	–	GI312	GI325	2.29	HM010
803D-54-162-S40	54	162.00	257.5	188	70	173	40	58	0.50	0.50	–	GI312	GI325	2.39	HM010
803D-55-165-S40	55	165.00	260	190	70	176	40	58	0.50	0.50	–	GI312	GI325	2.46	HM010
803D-56-168-S40	56	168.00	264	194	70	179	40	58	0.50	0.50	–	GI312	GI325	2.59	HM010
803D-57-171-S40	57	171.00	266.5	197	70	182	40	58	0.35	0.50	–	GI312	GI325	2.70	HM010
803D-58-174-S40	58	174.00	270	200	70	186	40	58	0.15	0.50	–	GI312	GI325	2.83	HM010

GI300	XPET 0502AP	SCET 050204-UD
GI301	XPET 0602AP	SCET 050204-UD
GI302	XPET 0602AP	SCET 060204-UD
GI303	XPET 0703AP	SCET 060204-UD
GI304	XPET 0703AP	SCET 070308-UD
GI305	XPET 0903AP	SCET 070308-UD
GI306	XPET 0903AP	SCET 09T308-UD
GI307	XPET 11T3AP	SCET 09T308-UD
GI308	XPET 11T3AP	SCET 120408-UD
GI309	XPET 12T3AP	SCET 120408-UD
GI310	XPET 1504AP	SCET 120408-UD
GI311	XPET 1504AP	SCET 150512-UD
GI312	XPET 1904AP	SCET 150512-UD
GI313	XPET 0502AP-SD	SCET 050204-SD
GI314	XPET 0602AP-SD	SCET 050204-SD
GI315	XPET 0602AP-SD	SCET 060204-SD
GI316	XPET 0703AP-SD	SCET 060204-SD
GI317	XPET 0703AP-SD	SCET 070308-SD
GI318	XPET 0903AP-SD	SCET 070308-SD
GI319	XPET 0903AP-SD	SCET 09T308-SD



GI320	XPET 11T3AP-SD	SCET 09T308-SD
GI321	XPET 11T3AP-SD	SCET 120408-SD
GI322	XPET 12T3AP-SD	SCET 120408-SD
GI323	XPET 1504AP-SD	SCET 120408-SD
GI324	XPET 1504AP-SD	SCET 150512-SD
GI325	XPET 1904AP-SD	SCET 150512-SD

HM001	US 2245-T07P	0.9	US 2245-T07P	0.9	FLAG T07P
HM002	US 2205-T07P	0.9	US 2245-T07P	0.9	FLAG T07P
HM003	US 2205-T07P	0.9	US 2205-T07P	0.9	FLAG T07P
HM004	US 2506-T07P	1.2	US 2506-T07P	1.2	FLAG T07P
HM005	US 2507-T08P	1.2	US 3007-T08P	2.0	FLAG T08P
HM006	US 3007-T09P	2.0	US 3007-T09P	2.0	FLAG T09P
HM007	US 3007-T09P	2.0	US 3009-T09P	2.0	FLAG T09P
HM008	US 3510-T15P	3.0	US 3508-T15P	3.0	FLAG T15P
HM009	US 3510-T15P	3.0	US 5012-T15P	5.0	FLAG T15P
HM010	US 4011-T15P	3.5	US 5012-T15P	5.0	FLAG T15P

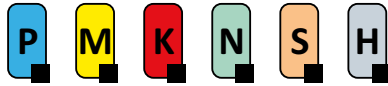
**804D**

PRAMET

S**4xD 804D Vrták s destičkami a vnitřním chlazením**

Vysoce výkonný vrták s destičkami pro vrtání slepých a průchozích otvorů. Také může být potenciálně použit pro křížení otvorů, vrtání mimo osu, spirálovou interpolaci, zajíždění pod úhlem, vrtání do vypouklých a šikmých ploch, vrtání v přerušovaném řezu, srážení úkosů a vyvrtávání. Dostupný v Ø17 - Ø58 mm a délce 4xD.

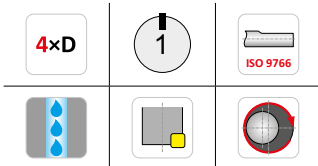
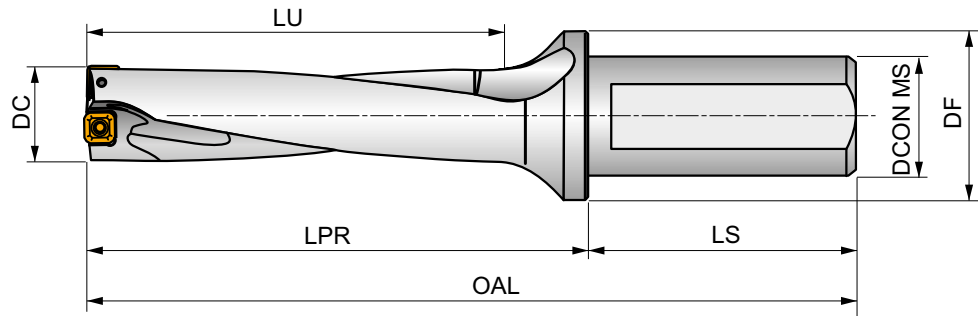

Produkt	DC	APMX	OAL	LPR	LS	LU	DCON MS	DF	\bar{D}	D^+				kg	
	(mm)	(mm)	(mm)	(mm)	(mm)	(mm)	(mm)	(mm)	(mm)	(mm)					
804D-17-68-S25	17	68.00	149	93	56	73	25	35	0.10	0.50	–	GI300	GI313	0.34	HM001
804D-18-72-S25	18	72.00	153	97	56	77	25	35	0.35	0.25	–	GI301	GI314	0.35	HM002
804D-19-76-S25	19	76.00	157	101	56	81.5	25	35	0.15	0.45	–	GI301	GI314	0.36	HM002
804D-20-80-S25	20	80.00	161	105	56	85	25	35	0.10	0.45	–	GI302	GI315	0.37	HM003
804D-21-84-S25	21	84.00	165	109	56	89.5	25	35	0.10	0.50	–	GI302	GI315	0.39	HM003
804D-22-88-S25	22	88.00	169	113	56	94	25	35	0.45	0.50	–	GI303	GI316	0.41	HM004
804D-23-92-S25	23	92.00	173	117	56	98.5	25	35	0.35	0.50	–	GI304	GI317	0.44	HM005
804D-24-96-S25	24	96.00	177	121	56	103	25	35	0.15	0.50	–	GI304	GI317	0.45	HM005
804D-25-100-S32	25	100.00	185	125	60	105	32	42	0.15	0.50	–	GI304	GI317	0.67	HM005
804D-26-104-S32	26	104.00	189	129	60	109.5	32	42	0.10	0.50	–	GI304	GI317	0.70	HM005
804D-27-108-S32	27	108.00	193	133	60	114	32	42	0.50	0.30	–	GI305	GI318	0.71	HM006
804D-28-112-S32	28	112.00	197	137	60	118.5	32	42	0.30	0.50	–	GI306	GI319	0.75	HM007
804D-29-116-S32	29	116.00	201	141	60	123	32	42	0.20	0.50	–	GI306	GI319	0.78	HM007
804D-30-120-S32	30	120.00	205	145	60	127.5	32	42	0.15	0.50	–	GI306	GI319	0.82	HM007
804D-31-124-S32	31	124.00	209	149	60	132	32	42	0.15	0.50	–	GI306	GI319	0.85	HM007
804D-32-128-S32	32	128.00	213	153	60	136.5	32	42	0.50	0.30	–	GI307	GI320	0.90	HM008
804D-33-132-S32	33	132.00	217	157	60	141	32	42	0.50	0.50	–	GI307	GI320	0.95	HM008
804D-34-136-S32	34	136.00	221	161	60	145.5	32	42	0.25	0.50	–	GI307	GI320	0.99	HM008
804D-35-140-S32	35	140.00	225	165	60	149	32	42	0.25	0.50	–	GI308	GI321	1.04	HM009
804D-36-144-S32	36	144.00	229	169	60	153.5	32	42	0.10	0.50	–	GI308	GI321	1.05	HM009
804D-37-148-S32	37	148.00	233	173	60	158	32	42	0.10	0.50	–	GI308	GI321	1.11	HM009
804D-38-152-S32	38	152.00	237	177	60	162.5	32	42	0.50	0.50	–	GI308	GI321	1.18	HM009
804D-39-156-S32	39	156.00	241	181	60	167	32	42	0.40	0.50	–	GI309	GI322	1.25	HM009
804D-40-160-S32	40	160.00	245	185	60	171.5	32	42	0.20	0.50	–	GI309	GI322	1.33	HM009
804D-41-164-S40	41	164.00	259	189	70	172	40	50	0.20	0.50	–	GI309	GI322	1.68	HM009
804D-42-168-S40	42	168.00	263	193	70	176.5	40	50	0.15	0.50	–	GI309	GI322	1.76	HM009
804D-43-172-S40	43	172.00	267	197	70	181	40	50	0.10	0.50	–	GI309	GI322	1.83	HM009



Produkt	DC	APMX	OAL	LPR	LS	LU	DCON/MS	DF	$\overset{\uparrow}{\downarrow}D$	D^{\uparrow}					
	(mm)	(mm)	(mm)	(mm)	(mm)	(mm)	(mm)	(mm)	(mm)	(mm)				kg	
804D-44-176-S40	44	176.00	271	201	70	185.5	40	50	0.50	0.50	–	GI310	GI323	1.91	HM010
804D-45-180-S40	45	180.00	275	205	70	187.5	40	55	0.50	0.50	–	GI311	GI324	2.02	HM010
804D-46-184-S40	46	184.00	279	209	70	192	40	55	0.50	0.50	–	GI311	GI324	2.12	HM010
804D-47-188-S40	47	188.00	283	213	70	196.5	40	55	0.50	0.50	–	GI311	GI324	2.22	HM010
804D-48-192-S40	48	192.00	287	217	70	201	40	55	0.50	0.50	–	GI311	GI324	2.33	HM010
804D-49-196-S40	49	196.00	291	221	70	205.5	40	55	0.30	0.50	–	GI311	GI324	2.45	HM010
804D-50-200-S40	50	200.00	295	225	70	208.5	40	58	0.15	0.50	–	GI311	GI324	2.58	HM010
804D-51-204-S40	51	204.00	299	229	70	213	40	58	0.15	0.50	–	GI311	GI324	2.68	HM010
804D-52-208-S40	52	208.00	303	233	70	217.5	40	58	0.50	0.50	–	GI312	GI325	2.64	HM010
804D-53-212-S40	53	212.00	307	237	70	222	40	58	0.50	0.50	–	GI312	GI325	2.76	HM010
804D-54-216-S40	54	216.00	311	241	70	226.5	40	58	0.50	0.50	–	GI312	GI325	2.90	HM010
804D-55-220-S40	55	220.00	315	245	70	231	40	58	0.50	0.50	–	GI312	GI325	3.00	HM010
804D-56-224-S40	56	224.00	319	249	70	235.5	40	58	0.50	0.50	–	GI312	GI325	3.15	HM010
804D-57-228-S40	57	228.00	323	253	70	240	40	58	0.35	0.50	–	GI312	GI325	3.30	HM010
804D-58-232-S40	58	232.00	327	257	70	244.5	40	58	0.15	0.50	–	GI312	GI325	3.46	HM010

GI300	XPET 0502AP	SCET 050204-UD
GI301	XPET 0602AP	SCET 050204-UD
GI302	XPET 0602AP	SCET 060204-UD
GI303	XPET 0703AP	SCET 060204-UD
GI304	XPET 0703AP	SCET 070308-UD
GI305	XPET 0903AP	SCET 070308-UD
GI306	XPET 0903AP	SCET 09T308-UD
GI307	XPET 11T3AP	SCET 09T308-UD
GI308	XPET 11T3AP	SCET 120408-UD
GI309	XPET 12T3AP	SCET 120408-UD
GI310	XPET 1504AP	SCET 120408-UD
GI311	XPET 1504AP	SCET 150512-UD
GI312	XPET 1904AP	SCET 150512-UD
GI313	XPET 0502AP-SD	SCET 050204-SD
GI314	XPET 0602AP-SD	SCET 050204-SD
GI315	XPET 0602AP-SD	SCET 060204-SD
GI316	XPET 0703AP-SD	SCET 060204-SD
GI317	XPET 0703AP-SD	SCET 070308-SD
GI318	XPET 0903AP-SD	SCET 070308-SD
GI319	XPET 0903AP-SD	SCET 09T308-SD
GI320	XPET 11T3AP-SD	SCET 09T308-SD
GI321	XPET 11T3AP-SD	SCET 120408-SD
GI322	XPET 12T3AP-SD	SCET 120408-SD
GI323	XPET 1504AP-SD	SCET 120408-SD
GI324	XPET 1504AP-SD	SCET 150512-SD
GI325	XPET 1904AP-SD	SCET 150512-SD

HM001	US 2245-T07P	0.9	US 2245-T07P	0.9	FLAG T07P
HM002	US 2205-T07P	0.9	US 2245-T07P	0.9	FLAG T07P
HM003	US 2205-T07P	0.9	US 2205-T07P	0.9	FLAG T07P
HM004	US 2506-T07P	1.2	US 2506-T07P	1.2	FLAG T07P
HM005	US 2507-T08P	1.2	US 3007-T08P	2.0	FLAG T08P
HM006	US 3007-T09P	2.0	US 3007-T09P	2.0	FLAG T09P
HM007	US 3007-T09P	2.0	US 3009-T09P	2.0	FLAG T09P
HM008	US 3510-T15P	3.0	US 3508-T15P	3.0	FLAG T15P
HM009	US 3510-T15P	3.0	US 5012-T15P	5.0	FLAG T15P
HM010	US 4011-T15P	3.5	US 5012-T15P	5.0	FLAG T15P



805D



PRAMET

S



5xD 805D Vrták s destičkami a vnitřním chlazením

Vysoce výkonný vrták s destičkami pro vrtání slepých a průchozích otvorů. Také může být potenciálně použit pro křížení otvorů, vrtání mimo osu, spirálovou interpolaci, zajíždění pod úhlem, vrtání do vypouklých a šikmých ploch, vrtání v přerušovaném řezu, srážení úkosů a vyvrtávání. Dostupný v Ø19 - Ø31 mm a délce 5xD.

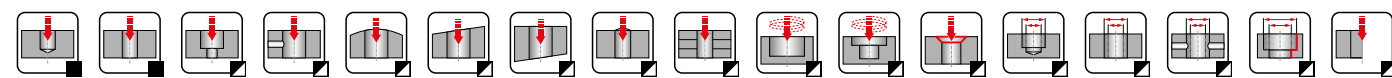
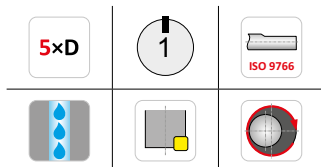
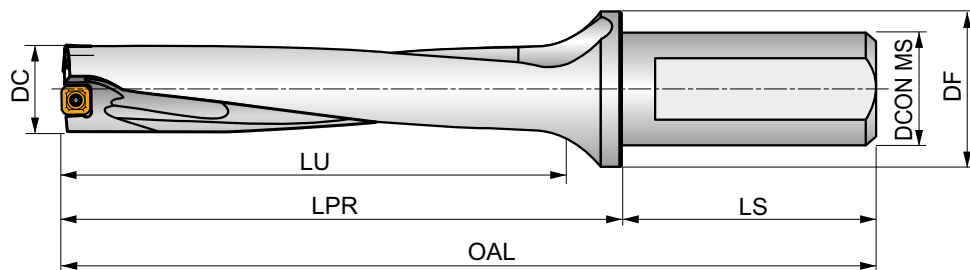

Produkt	DC	APMX	OAL	LPR	LS	LU	DCON MS	DF	\bar{D}	D^+					kg	
	(mm)	(mm)	(mm)	(mm)	(mm)	(mm)	(mm)	(mm)	(mm)	(mm)						
805D-19-95-S25	19	95.00	176	120	56	100.5	25	35	0.15	0.45	–	GI301	GI314	0.38	HM002	
805D-20-100-S25	20	100.00	181	125	56	105	25	35	0.10	0.45	–	GI302	GI315	0.40	HM003	
805D-21-105-S25	21	105.00	186	130	56	110.5	25	35	0.10	0.50	–	GI302	GI315	0.42	HM003	
805D-22-110-S25	22	110.00	191	135	56	116	25	35	0.45	0.50	–	GI303	GI316	0.45	HM004	
805D-23-115-S25	23	115.00	196	140	56	121.5	25	35	0.35	0.50	–	GI304	GI317	0.48	HM005	
805D-24-120-S25	24	120.00	201	145	56	127	25	35	0.15	0.50	–	GI304	GI317	0.49	HM005	
805D-25-125-S32	25	125.00	210	150	60	130	32	42	0.15	0.50	–	GI304	GI317	0.72	HM005	
805D-26-130-S32	26	130.00	215	155	60	135.5	32	42	0.10	0.50	–	GI304	GI317	0.75	HM005	
805D-27-135-S32	27	135.00	220	160	60	141	32	42	0.50	0.30	–	GI305	GI318	0.78	HM006	
805D-28-140-S32	28	140.00	225	165	60	146.5	32	42	0.30	0.50	–	GI306	GI319	0.82	HM007	
805D-29-145-S32	29	145.00	230	170	60	152	32	42	0.20	0.50	–	GI306	GI319	0.86	HM007	
805D-30-150-S32	30	150.00	235	175	60	157.5	32	42	0.15	0.50	–	GI306	GI319	0.90	HM007	
805D-31-155-S32	31	155.00	240	180	60	163	32	42	0.15	0.50	–	GI306	GI319	0.95	HM007	

GI301	XPET 0602AP	SCET 050204-UD
GI302	XPET 0602AP	SCET 060204-UD
GI303	XPET 0703AP	SCET 060204-UD
GI304	XPET 0703AP	SCET 070308-UD
GI305	XPET 0903AP	SCET 070308-UD
GI306	XPET 0903AP	SCET 09T308-UD
GI314	XPET 0602AP-SD	SCET 050204-SD
GI315	XPET 0602AP-SD	SCET 060204-SD
GI316	XPET 0703AP-SD	SCET 060204-SD
GI317	XPET 0703AP-SD	SCET 070308-SD
GI318	XPET 0903AP-SD	SCET 070308-SD



GI319	XPET 0903AP-SD	SCET 09T308-SD

HM002	US 2205-T07P	0.9	US 2245-T07P	0.9	FLAG T07P
HM003	US 2205-T07P	0.9	US 2205-T07P	0.9	FLAG T07P
HM004	US 2506-T07P	1.2	US 2506-T07P	1.2	FLAG T07P
HM005	US 2507-T08P	1.2	US 3007-T08P	2.0	FLAG T08P
HM006	US 3007-T09P	2.0	US 3007-T09P	2.0	FLAG T09P
HM007	US 3007-T09P	2.0	US 3009-T09P	2.0	FLAG T09P

**EP****PRAMET****Excentrické pouzdro pro vyosení destičkových vrtáků**

Pouzdro slouží k nastavení průměru destičkových vrtáků (lze nastavit vrtaný průměr menší i větší než je nominální průměr vrtáku). Dostupná jsou pouzdra pro stopky Weldon Ø32 a Ø40 mm. Průměr vrtáku se nastavuje pootáčením pouzdra.

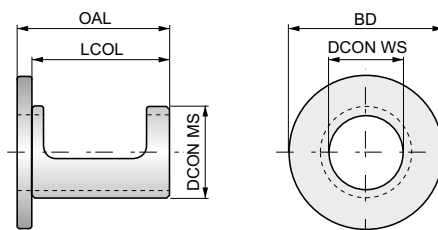

Rozsah nastavení průměru je 0,4 až -0,2; rozsah nastavení výšky středu je 0,2 až -0,15.

Produkt	DCON WS (mm)	DCON MS (mm)	BD (mm)	OAL (mm)	LCOL (mm)	
EP253253	25.00	32.00	53.00	53.0	48	0.15
EP324058	32.00	40.00	58.00	58.0	53	0.20



SCET



	IC (mm)	D1 (mm)	L (mm)	S (mm)
0502	5.556	2.40	5.56	2.38
0602	6.350	2.90	6.35	2.38
0703	7.937	3.50	7.94	3.18
09T3	9.525	4.50	9.53	3.97
1204	12.700	5.60	12.70	4.76
1505	15.875	5.60	15.88	5.56

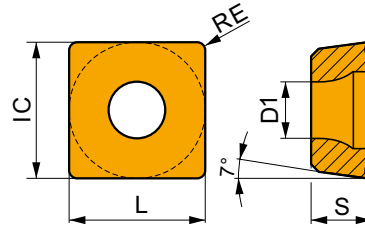

Startovní rezné podmínky, rezná rychlost (Vc), posuv (f) a hloubka řezu (Ap). Další výpočty naleznete v naší aplikaci Kalkulátor rezných podmínek.

Produkt	RE (mm)	P			M			K			N			S			H		
		vc (m/min)	f (mm/rev)	ap (mm)	vc (m/min)	f (mm/rev)	ap (mm)	vc (m/min)	f (mm/rev)	ap (mm)	vc (m/min)	f (mm/rev)	ap (mm)	vc (m/min)	f (mm/rev)	ap (mm)	vc (m/min)	f (mm/rev)	ap (mm)

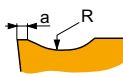

SCET 050204-UD 0,12
 SCET 060204-UD 0,15
 SCET 070308-UD 0,15
 SCET 09T308-UD 0,15
 SCET 120408-UD 0,20
 SCET 150512-UD 0,20

UD utvařeč s univerzální geometrií pro vnější destičky.

SCET 050204-UD	D8330	0.4	165	0.08	–	–	–	–	155	0.08	–	–	–	–	–	–	–	–
	D9335	0.4	240	0.08	–	–	–	–	225	0.08	–	–	–	–	–	–	–	–
SCET 060204-UD	D8330	0.4	165	0.11	–	–	–	–	155	0.11	–	–	–	–	–	–	–	–
	D9335	0.4	240	0.11	–	–	–	–	225	0.11	–	–	–	–	–	–	–	–
SCET 070308-UD	D8330	0.8	165	0.13	–	–	–	–	155	0.13	–	–	–	–	–	–	–	–
	D9335	0.8	240	0.13	–	–	–	–	225	0.13	–	–	–	–	–	–	–	–
SCET 09T308-UD	D8330	0.8	165	0.14	–	–	–	–	155	0.14	–	–	–	–	–	–	–	–
	D9335	0.8	240	0.14	–	–	–	–	225	0.14	–	–	–	–	–	–	–	–
SCET 120408-UD	D8330	0.8	165	0.16	–	–	–	–	155	0.16	–	–	–	–	–	–	–	–
	D9335	0.8	240	0.16	–	–	–	–	225	0.16	–	–	–	–	–	–	–	–
SCET 150512-UD	D8330	1.2	165	0.18	–	–	–	–	155	0.18	–	–	–	–	–	–	–	–
	D9335	1.2	240	0.18	–	–	–	–	225	0.18	–	–	–	–	–	–	–	–

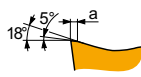

SCET 050204-SD 0,04
 SCET 060204-SD 0,06
 SCET 070308-SD 0,08
 SCET 09T308-SD 0,10
 SCET 120408-SD 0,10
 SCET 150512-SD 0,10

SD utvařeč s pozitivní geometrií pro vnější destičky.

SCET 050204-SD	D8330	0.4	165	0.08	–	95	0.07	–	155	0.08	–	–	–	–	40	0.06	–	–	–
	D9335	0.4	240	0.08	–	140	0.07	–	225	0.08	–	–	–	–	60	0.06	–	–	–
SCET 060204-SD	D8330	0.4	165	0.11	–	95	0.09	–	155	0.11	–	–	–	–	40	0.07	–	–	–
	D9335	0.4	240	0.11	–	140	0.09	–	225	0.11	–	–	–	–	60	0.07	–	–	–
SCET 070308-SD	D8330	0.8	165	0.13	–	95	0.11	–	155	0.13	–	–	–	–	40	0.09	–	–	–
	D9335	0.8	240	0.13	–	140	0.11	–	225	0.13	–	–	–	–	60	0.09	–	–	–
SCET 09T308-SD	D8330	0.8	165	0.14	–	95	0.13	–	155	0.14	–	–	–	–	40	0.10	–	–	–
	D9335	0.8	240	0.14	–	140	0.13	–	225	0.14	–	–	–	–	60	0.10	–	–	–
SCET 120408-SD	D8330	0.8	165	0.16	–	95	0.14	–	155	0.16	–	–	–	–	40	0.11	–	–	–
	D9335	0.8	240	0.16	–	140	0.14	–	225	0.16	–	–	–	–	60	0.11	–	–	–
SCET 150512-SD	D8330	1.2	165	0.18	–	95	0.16	–	155	0.18	–	–	–	–	40	0.12	–	–	–
	D9335	1.2	240	0.18	–	140	0.16	–	225	0.18	–	–	–	–	60	0.12	–	–	–



XPET

	IC (mm)	D1 (mm)	L (mm)	S (mm)
0502	5.556	2.40	5.56	2.38
0602	6.350	2.60	6.35	2.38
0703	7.937	2.90	7.94	3.18
0903	9.525	3.50	9.53	3.18
11T3	11.509	3.90	11.50	3.97
12T3	12.700	3.90	12.70	3.97
1504	15.875	4.50	15.88	4.76
1904	19.050	4.50	19.05	4.76

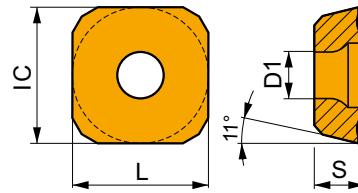

Startovní řezné podmínky, řezná rychlost (Vc), posuv (f) a hloubka řezu (Ap). Další výpočty naleznete v naší aplikaci Kalkulátor řezných podmínek.

Produkt	RE (mm)	P			M			K			N			S			H		
		vc (m/min)	f (mm/rev)	ap (mm)	vc (m/min)	f (mm/rev)	ap (mm)	vc (m/min)	f (mm/rev)	ap (mm)	vc (m/min)	f (mm/rev)	ap (mm)	vc (m/min)	f (mm/rev)	ap (mm)	vc (m/min)	f (mm/rev)	ap (mm)

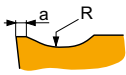

XPET 0502AP	0,10
XPET 0602AP	0,10
XPET 0703AP	0,15
XPET 0903AP	0,25
XPET 11T3AP	0,25
XPET 12T3AP	0,25
XPET 1504AP	0,25
XPET 1904AP	0,25

Utvařec s univerzální geometrií pro středové destičky.

XPET 0502AP	D8345	—	■	165	0.08	—	—	—	—	■	155	0.08	—	—	—	—	—	—	—
XPET 0602AP	D8345	—	■	165	0.11	—	—	—	—	■	155	0.11	—	—	—	—	—	—	—
XPET 0703AP	D8345	—	■	165	0.13	—	—	—	—	■	155	0.13	—	—	—	—	—	—	—
XPET 0903AP	D8345	—	■	165	0.14	—	—	—	—	■	155	0.14	—	—	—	—	—	—	—
XPET 11T3AP	D8345	—	■	165	0.16	—	—	—	—	■	155	0.16	—	—	—	—	—	—	—
XPET 12T3AP	D8345	—	■	165	0.16	—	—	—	—	■	155	0.16	—	—	—	—	—	—	—
XPET 1504AP	D8345	—	■	165	0.18	—	—	—	—	■	155	0.18	—	—	—	—	—	—	—
XPET 1904AP	D8345	—	■	165	0.18	—	—	—	—	■	155	0.18	—	—	—	—	—	—	—

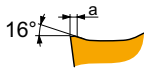

XPET 0502AP-SD	0,04
XPET 0602AP-SD	0,05
XPET 0703AP-SD	0,08
XPET 0903AP-SD	0,10
XPET 11T3AP-SD	0,10
XPET 12T3AP-SD	0,10
XPET 1504AP-SD	0,10
XPET 1904AP-SD	0,12

SD utvařec s pozitivní geometrií pro středové destičky.

XPET 0502AP-SD	D8345	—	■	165	0.08	—	■	95	0.07	—	■	155	0.08	—	—	—	■	40	0.06	—	—	—
XPET 0602AP-SD	D8345	—	■	165	0.11	—	■	95	0.09	—	■	155	0.11	—	—	—	■	40	0.07	—	—	—
XPET 0703AP-SD	D8345	—	■	165	0.13	—	■	95	0.11	—	■	155	0.13	—	—	—	■	40	0.09	—	—	—
XPET 0903AP-SD	D8345	—	■	165	0.14	—	■	95	0.13	—	■	155	0.14	—	—	—	■	40	0.10	—	—	—
XPET 11T3AP-SD	D8345	—	■	165	0.16	—	■	95	0.14	—	■	155	0.16	—	—	—	■	40	0.11	—	—	—
XPET 12T3AP-SD	D8345	—	■	165	0.16	—	■	95	0.14	—	■	155	0.16	—	—	—	■	40	0.11	—	—	—
XPET 1504AP-SD	D8345	—	■	165	0.18	—	■	95	0.16	—	■	155	0.18	—	—	—	■	40	0.12	—	—	—
XPET 1904AP-SD	D8345	—	■	165	0.18	—	■	95	0.16	—	■	155	0.18	—	—	—	■	40	0.12	—	—	—







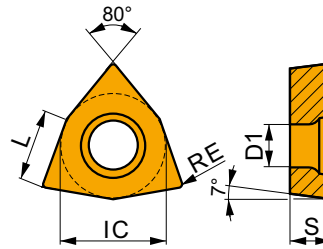



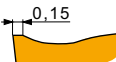







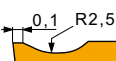

WCMT-ID

	IC	D1	L	S
	(mm)	(mm)	(mm)	(mm)
0402	6.350	2.90	4.30	2.38
0503	7.938	3.50	5.40	3.18
06T3	9.525	4.40	6.50	3.97
0804	12.700	5.50	8.70	4.76

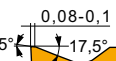

Startovní řezné podmínky, řezná rychlost (Vc), posuv (f) a hloubka řezu (Ap). Další výpočty naleznete v naší aplikaci Kalkulátor řezných podmínek.

Produkt	RE	P			M			K			N			S			H		
		vc	f	ap	vc	f	ap	vc	f	ap	vc	f	ap	vc	f	ap	vc	f	ap
	(mm)	(m/min)	(mm/rev)	(mm)	(m/min)	(mm/rev)	(mm)	(m/min)	(mm/rev)	(mm)	(m/min)	(mm/rev)	(mm)	(m/min)	(mm/rev)	(mm)	(m/min)	(mm/rev)	(mm)
				Utvařeč 45 pro dokončovací obrábění až hrubování; pro hladké až přerušované řezy.															
WCMT 06T308E-45	D8330 0.8	165	0.15	-	95	0.14	-	155	0.15	-	-	-	-	-	-	-	-	-	-
				Utvařeč 46 pro jemné až dokončovací obrábění; pro hladké až přerušované řezy.															
WCMT 040208E-46	D8330 0.8	165	0.15	-	95	0.14	-	155	0.15	-	-	-	-	-	-	-	-	-	-
				Utvařeč 47 pro dokončovací až střední obrábění; pro hladké až přerušované řezy.															
WCMT 050308E-47	D8330 0.8	165	0.20	-	95	0.18	-	155	0.20	-	-	-	-	-	-	-	-	-	-
				Utvařeč 48 pro dokončovací až střední obrábění; pro hladké až přerušované řezy.															
WCMT 080412E-48	D8330 1.2	165	0.22	-	95	0.22	-	155	0.22	-	-	-	-	-	-	-	-	-	-
				Utvařeč UM pro dokončovací až střední obrábění; pro hladké až mírně přerušované řezy.															
WCMT 040208E-UM	D8330 0.8	165	0.20	-	95	0.18	-	155	0.20	-	-	-	-	-	-	-	-	-	-
WCMT 050308E-UM	D8330 0.8	165	0.20	-	95	0.18	-	155	0.20	-	-	-	-	-	-	-	-	-	-







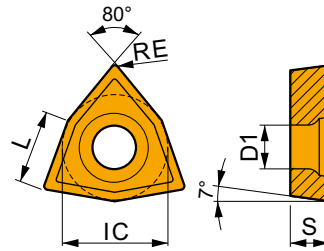



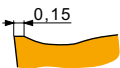





WCMX

	IC	D1	L	S
	(mm)	(mm)	(mm)	(mm)
0302	5.556	2.85	3.80	2.38
0402	6.350	3.15	4.30	2.38
0503	7.938	3.20	5.40	3.18
06T3	9.525	3.72	6.50	3.97
0804	12.700	4.30	8.70	4.76



Startovní řezné podmínky, řezná rychlost (Vc), posuv (f) a hloubka řezu (Ap). Další výpočty naleznete v naší aplikaci Kalkulátor řezných podmínek.

Produkt	RE	P			M			K			N			S			H		
		vc	f	ap	vc	f	ap	vc	f	ap	vc	f	ap	vc	f	ap	vc	f	ap
	(mm)	(m/min)	(mm/rev)	(mm)	(m/min)	(mm/rev)	(mm)	(m/min)	(mm/rev)	(mm)	(m/min)	(mm/rev)	(mm)	(m/min)	(mm/rev)	(mm)	(m/min)	(mm/rev)	(mm)
				Utvařec 45 pro dokončovací obrábění až hrubování; pro hladké až přerušované řezy.															
WCMX 06T308E-45	D8330	0.8	165	0.15	95	0.14	155	0.15	-	-	-	-	-	-	-	-	-	-	-
				Utvařec 46 pro jemné až dokončovací obrábění; pro hladké až přerušované řezy.															
WCMX 030208E-46	D8330	0.8	165	0.15	95	0.14	155	0.15	-	-	-	-	-	-	-	-	-	-	-
WCMX 040208E-46	D8330	0.8	165	0.15	95	0.14	155	0.15	-	-	-	-	-	-	-	-	-	-	-
				Utvařec 47 pro dokončovací až střední obrábění; pro hladké až přerušované řezy.															
WCMX 050308E-47	D8330	0.8	165	0.20	95	0.18	155	0.20	-	-	-	-	-	-	-	-	-	-	-
				Utvařec 48 pro dokončovací až střední obrábění; pro hladké až přerušované řezy.															
WCMX 080412E-48	D8330	1.2	165	0.22	95	0.20	155	0.22	-	-	-	-	-	-	-	-	-	-	-



VRTÁNÍ
TECHNICKÉ INFORMACE



SKUPINY OBRÁBĚNÝCH MATERIÁLŮ (WMG)

ISO Pro výběr materiálu řezného nástroje a geometrie pro širokou škálu materiálů obrobků

Obecná definice
tj. ocel, korozivzdorná ocel...

P **M** **K** **N** **S** **H**

Podskupina Pro volbu vhodného nástroje pro specifičtější rozdělení materiálů obrobků

Rozdělení podle struktury/složení
tj. běžná uhlíková ocel, legovaná ocel...

P **M** **K** **N** **S** **H**

P1

P2

P3

P4

WMG Pro výběr počátečních řezných podmínek s rozsahem $\pm 10\%$

Rozdělení podle tvrdosti/meze pevnosti v tahu
tj. $160 < 220 \text{ HB}$, $620 < 900 \text{ N/mm}^2$...

P

P1 **P1.1** **P1.2** **P1.3**

P2 **P2.1** **P2.2** **P2.3**

P3 **P3.1** **P3.2** **P3.3**

P4 **P4.1** **P4.2** **P4.3**

ROZLIŠENÍ OBRÁBĚNÝCH MATERIÁLŮ SPOLEČNOSTI DORMER PRAMET

Skupiny materiálů obrobků (WMG) se používají k usnadnění výběru správného řezného nástroje a k výběru počátečních řezných podmínek v konkrétním použití.

Norma ISO 513 klasifikuje obráběné materiály do šesti různě zbarvených skupin:

- **Modrá:** ocel a ocelolitina (skupina P)
- **Žlutá:** korozivzdorná ocel (skupina M)
- **Červená:** litina (skupina K)
- **Zelená:** neželezné kovy (skupina N)
- **Hnědá:** žárupevné slitiny (skupina S)
- **Šedá:** kalené materiály (skupina H)

Šest základních ISO skupin se dále dělí na podskupiny na základě struktury a složení materiálů. Například ocel a ocelolitina skupiny P se dělí na tyto čtyři podskupiny:

- P1 – **automatová ocel**
- P2 – **běžná uhlíková ocel**
- P3 – **legovaná ocel**
- P4 – **nástrojová ocel**

Třetí úroveň rozdělení zahrnuje vlastnosti materiálu, jako je tvrdost a mez pevnosti v tahu. Zde poskytujeme našim zákazníkům výběr vhodného nástroje, včetně doporučených počátečních řezných podmínek.

Tabulka na následující straně uvádí popis jednotlivých skupin obráběných materiálů a příklady běžně používaných označení.

Skup. podle ISO	Podskupina	WMG (skupina materiálů obrobků)	k_{pc}	Příklady materiálu (AISI, EN, DIN, ČSN, GB, SS, STN, BS, UNE, AFNOR, ASTM, GOST, UNS, UNI, ...)
P Ocel a ocelolitina (oceli s obsahem legujících prvků ≤ 10 % a tvrdostí < 45 HRC)	P1 Automatová ocel (uhlíkové oceli se zvýšenou obrobitelností)	P1.1 Automatová uhlíková ocel obsahující síru s tvrdostí < 240 HB	1.33	AISI 1108, EN 1552, DIN 1.0723, SS 1922, ČSN 11120, BS 210A15, UNE F.210F, GB Y15, AFNOR 10F1, GOST A30, UNI CF10S20
		P1.2 Automatová uhlíková ocel obsahující síru a fosfor s tvrdostí < 180 HB	1.49	AISI 1211, EN 115Mn30, DIN 1.0715, SS 1912, ČSN 11109, BS 230M7, UNE F.2111, GB Y15, AFNOR S250, GOST A40G, UNI CF95Mn28
		P1.3 Automatová uhlíková ocel obsahující síru, fosfor a olovo s tvrdostí < 180 HB	1.53	AISI 12L13, EN 115MnPb30, DIN 1.0718, SS 1914, ČSN 12110, BS 210M16, UNE F.2114, GB Y15Pb, AFNOR S250Pb, GOST A35G2, UNI CF10SPb20
	P2 Běžná uhlíková ocel (oceli skládající se převážně z železa a uhlíku)	P2.1 Běžná nízkouhlíková ocel obsahující < 0,25 % C s tvrdostí < 180 HB	1.14	AISI 1015, EN C15, DIN 1.0401, SS 1350, ČSN 11301, BS 080A15, UNE F.111, GB 15, AFNOR C18RR, GOST S22ps, UNI Fe360
		P2.2 Běžná středně uhlíková ocel obsahující < 0,55 % C s tvrdostí < 240 HB	1.00	AISI 1030, EN C30, DIN 1.0528, SS 1550, ČSN 12031, BS 080M32, UNE F.1130, GB 30, AFNOR AF50C30, GOST 30G, UNI Fe590
		P2.3 Běžná vysoce uhlíková ocel obsahující > 0,55 % C s tvrdostí < 300 HB	0.89	AISI 1060, EN C60, DIN 1.0601, SS 1655, ČSN 12061, BS 080A62, UNE F.513, GB 60, AFNOR 1C60, GOST 60G, UNI C60
	P3 Legovaná ocel (uhlíkové oceli s obsahem legujících prvků ≤ 10 %)	P3.1 Legovaná ocel s tvrdostí < 180 HB	0.92	AISI 5015, EN 16Mo3, DIN 1.5415, SS 2912, ČSN 15020, BS 1501-240, UNE F.2601, GB 16Mo, AFNOR 15D3, GOST 15M, UNI 16Mo3KW
		P3.2 Legovaná ocel s tvrdostí 180–260 HB	0.74	AISI 4140, EN 42CrMo4, DIN 1.7225, SS 2244, ČSN 15142, BS 708M40, UNE F.8232, GB 42CrMo, AFNOR 42CD4, GOST 40CHFA, UNI 42CrMo4
		P3.3 Legovaná ocel s tvrdostí 260–360 HB	0.63	AISI 4140, EN 42CrMo4, DIN 1.7225, SS 2244, ČSN 15142, BS 708M40, UNE F.8232, GB 42CrMo, AFNOR 42CD4, GOST 40CHFA, UNI 42CrMo4
	P4 Nástrojová ocel (speciální legovaná ocel pro nástroje, závitová očka a formy)	P4.1 Nástrojová ocel s tvrdostí < 26 HRC	0.55	AISI D2, EN X155CrVMo12-1, DIN 1.2370, SS 2736, ČSN 19573, BS BD2, UNE F.520A, GB Cr12Mo1V1, AFNOR Z160CDV12, GOST Ch12MF, UNI X155CrVMo121KU
		P4.2 Nástrojová ocel s tvrdostí 26–39 HRC	0.47	AISI D2, EN X155CrVMo12-1, DIN 1.2370, SS 2736, ČSN 19573, BS BD2, UNE F.520A, GB Cr12Mo1V1, AFNOR Z160CDV12, GOST Ch12MF, UNI X155CrVMo121KU
		P4.3 Nástrojová ocel s tvrdostí 39–45 HRC	0.38	AISI D2, EN X155CrVMo12-1, DIN 1.2370, SS 2736, ČSN 19573, BS BD2, UNE F.520A, GB Cr12Mo1V1, AFNOR Z160CDV12, GOST Ch12MF, UNI X155CrVMo121KU



SKUPINY MATERIÁLŮ OBROBKŮ (WMG)

Skup. podle ISO	Podskupina	WMG (skupina materiálů obrobků)	k_{vg}	Příklady materiálu (AISI, EN, DIN, ČSN, GB, SS, STN, BS, UNE, AFNOR, ASTM, GOST, UNS, UNI, ...)
M Korozivzdorná ocel (korozivzdorné oceli s obsahem chromu $\geq 11\%$)	M1 Feritická korozivzdorná ocel (běžné chromové nekalitelné slitiny)	M1.1 Korozivzdorná ocel, feritická s tvrdostí < 160 HB	1.22	AISI 5429, EN X7Cr14, DIN 1.4001, SS 2326, BS 434517, UNE F.3401, AFNOR Z8C12, GOST 08Ch13, UNI X6CrTi12
		M1.2 Korozivzdorná ocel, feritická s tvrdostí 160–220 HB	1.03	AISI 446, EN X10CrAl24, DIN 1.4762, SS 2322, ČSN 17113, BS 430517, UNE F.3154, GB 10Cr17, AFNOR Z10CA524, GOST 12Ch17, UNI X16Cr26
		M2.1 Korozivzdorná ocel, martenzitická s tvrdostí < 200 HB	1.08	AISI 430F, EN X14CrMo517, DIN 1.4104, SS 2383, ČSN 17140, BS 410521, UNE F.3117, AFNOR Z10CF17, UNI X10Cr517
		M2.2 Korozivzdorná ocel, martenzitická s tvrdostí 200–280 HB	0.89	AISI 440C, EN X105CrMo17, DIN 1.4125, SS 2385, ČSN 17023, BS 425C11, UNE F.3402, GB 102Cr17Mo, AFNOR Z100CD17, GOST 95Ch18, UNI GX6CrNi 13 04
		M2.3 Korozivzdorná ocel, martenzitická s tvrdostí 280–380 HB	0.75	AISI 420, EN X45Cr13, DIN 1.4034, ČSN 17029, BS 425C11, UNE F.3405, AFNOR Z44C14, GOST 20X17H12, UNI X30Cr13
		M3.1 Korozivzdorná ocel, austenitická s tvrdostí < 200 HB	1.00	AISI 304, EN X5CrNi18-12, DIN 1.4303, SS 2352, ČSN 17249, BS 305517, UNE F.3513, GB 10Cr18Ni12, AFNOR Z8CN18.12, UNI X7CrNi18 10
	M3 Austenitická korozivzdorná ocel (chrom-niklové a chrom-nikl-manganové slitiny)	M3.2 Korozivzdorná ocel, austenitická s tvrdostí 200–260 HB	0.86	AISI 309, EN X15CrNiSi20-12, DIN 1.4828, ČSN 17251, BS 309S24, UNE F.3312, GB 1G23Ni13, AFNOR Z15CNS20.12, GOST 20Ch20Ni452, UNI 16CrNi23 14
		M3.3 Korozivzdorná ocel, austenitická s tvrdostí 260–300 HB	0.77	AISI 5848, EN X45CrNiW18-9, DIN 1.4873, BS 331540, UNE F.3211, AFNOR Z35CNW514-4, UNI X45CrNiW 18 9
		M4 Superaustenitická, duplexní nebo precipitačně vytvrzená korozivzdorná ocel (austenitické slitiny s $> 20\%$ Ni, austeniticko-feritickou mikrostrukturou nebo precipitačně vytvrzené)	M4.1 Korozivzdorná ocel, austeniticko-feritická nebo superaustenitická s tvrdostí < 300 HB	0.75
	M4.2 Korozivzdorná ocel, precipitačně vytvrzená austenitická s tvrdostí 300–380 HB		0.64	AISI 631 (17-7PH), EN X7CrNiAl17-7, DIN 1.4568, SS 2388, ČSN 17465, BS 301513, UNE F.3217, GB 07Cr17Ni7Al, AFNOR Z9CNA17-07, GOST 09Ch17Ni7Al, UNI X53CrMnNiN21 9



SKUPINY MATERIÁLŮ OBROBKŮ (WMG)

Skup. podle ISO	Podskupina	WMG (skupina materiálů obrobků)	k_{wc}	Příklady materiálů (AISI, EN, DIN, ČSN, GB, SS, STN, BS, UNE, AFNOR, ASTM, GOST, UNS, UNI, ...)
K1	Šedá litina (GG) (železo-uhlíkové odlitky s lamelární grafitovou mikrostrukturou)	K1.1	1.35	ASTM A48 Grade 20 (F11401), EN-JL-100, DIN GG-10 (0.6010), SS 0110, STN 422410, BS Grade 150, UNE FG10, GB HAT 100, AFNOR Fc10D, GOST SC 10, UNI G10
		K1.2	1.00	ASTM A48 Grade 30 (F12101), EN-JL-1030, DIN GG-20 (0.6020), SS 0120, STN 422420, BS Grade 220, UNE FG20, GB HT200, AFNOR Fc20D, GOST Ч20, UNI G20
		K1.3	0.75	ASTM A48 Grade 50 (F13501), EN-JL-1060, DIN GG-35 (0.6035), SS 0135, STN 422435, BS Grade 350, UNE FG35, GB HAT300, AFNOR Fc35D, GOST SC35, UNI G35
K2	Temperovaná litina (GTS/GTW) (tepelně zúšlechťené železo-uhlíkové odlitky s bezgrafitovou mikrostrukturou)	K2.1	1.39	ASTM A602 Grade M3210 (F20000), EN-JM-1130, DIN GTS-35 (0.8135), SS 0815, BS B340/12, UNE Type A, AFNOR MN 35-10, GOST K435-10
		K2.2	1.13	ASTM A602 Grade M4504 (F20001), EN-JM-1040, DIN GTS-50-05 (0.8045), BS P50-05, AFNOR MB 45-7
		K2.3	0.90	ASTM A602 Grade M7002 (F20004), EN-JM-1140, DIN GTS-45 (0.8145), SS 0854, STN 422540, BS P 45-06, UNE Typ B, AFNOR MP 50-5, GOST K445-7, UNI GMN 45
K3	Tvárná litina (GGG) (železo-uhlíkové odlitky s nodulární grafitovou mikrostrukturou)	K3.1	1.23	ASTM A536 Grade 60-40-18 (F32800), EN-JS-1030, DIN GGG-40 (0.7040), SS 0717, STN 422304, BS 420/12, UNE FGE 42-12, GB QT 400, AFNOR FGS 400-12, GOST B440
		K3.2	0.94	ASTM A536 Grade 80-55-06 (F33800), EN-JS-1050, DIN GGG-50 (0.7050), SS 0727, STN 422305, BS 500/7, UNE FGE 50-7, GB QT 500-7, AFNOR FGS 500-7, GOST B450
		K3.3	0.76	ASTM A536 Grade 100-70-03 (F34800), EN-JS-1060, DIN GGG-60 (0.7060), SS 0732, STN 422306, BS 600/3, UNE FGT 0-2, GB QT 600-3, AFNOR FGS 600-3, GOST B460
K4	Austenitická nebo izotermicky kalená tvárná litina (Ni-Resist/ADI) (odlitky ze železo-uhlíkových slitin s austenitickou nebo ausferitickou mikrostrukturou)	K4.1	1.14	ASTM A436 Type 1 (L-NiCuCr 15 6 2, F41000), EN-JL-3011, DIN GGL-NiMn 13 7 (0.6652), SS 0523, BS Grade F1, AFNOR FGL-Ni13Mn7, GOST S-NiMn 13 7
		K4.2	0.86	ASTM A439 Type D-2B (S-NiCr 20 3, F43001), EN-JS-3021, DIN GGG-NiMn 23 4, SS 0776, BS Grade S2M, AFNOR FGS Ni23 Mn4, GOST ЧH19X3U
		K4.3	0.63	ASTM A897 Grade 110-70-11
K5	Litina s kompaktním grafitem (CGI) (odlitky ze železo-uhlíkových slitin s vermikulární grafitovou strukturou)	K4.4	0.54	ASTM A897 Grade 125-80-10, EN-JS-1100, DIN GGG-90 (5.3400)
		K4.5	0.45	ASTM A897 Grade 2 (150-110-07), EN-JS-1110, DIN GGG-100 (5.3403)
		K5.1	1.29	ASTM A842 Grade 300, EN-GJV-300, DIN GGV 30, GOST ЧBT30,
K5	Litina s kompaktním grafitem (CGI) (odlitky ze železo-uhlíkových slitin s vermikulární grafitovou strukturou)	K5.2	0.97	ASTM A842 Grade 350, EN-GJV-350, DIN GGV 35 (5.2200), GOST ЧBT30,
		K5.3	0.75	ASTM A842 Grade 450, EN-GJV-450, DIN GGV 45, GOST ЧBT45,



SKUPINY MATERIÁLŮ OBROBKŮ (WMG)

Skup. podle ISO	Podskupina	WMG (skupina materiálů obrobků)	k_{vg}	Příklady materiálu (AISI, EN, DIN, ČSN, GB, SS, STN, BS, UNE, AFNOR, ASTM, GOST, UNS, UNI, ...)
N Neželezné kovy (kovy včetně slitin bez znatelného množství železa)	N1 Tvářený hliník	N1.1 Čistý hliník a tvářené slitiny hliníku s tvrdostí < 60 HB	1.33	UNS A91200, EN AL99.6, DIN 3.0205, SS 4010, STN 424009, BS 1C, UNE L-3001, GB L5, AFNOR A4, GOST AĐC, UNI 3567
		N1.2 Tvářené slitiny hliníku s tvrdostí 60–100 HB	1.00	UNS A93004, EN AlMn0.5Mg0.5, DIN 3.0505, SS 4054, STN 424432, BS N31, UNE L-3831, GB LF2, AFNOR A-M1, GOST AMu, UNI 3568
		N1.3 Tvářené slitiny hliníku s tvrdostí 100–150 HB	0.67	UNS A95083, EN AlMg4.5Mn0.7, DIN 3.3547, SS 4140, STN 424415, BS N8, UNE L-3321, GB AlMg4.5Mn, AFNOR A-G4.5Mn, GOST Amg 4.5, UNI P-AlMg4.4
	N2 Odléváný hliník	N2.1 Odlévané slitiny hliníku s tvrdostí < 75 HB	0.67	UNS A02080, EN AlCu45, BS LM11, STN 424331, UNE AlSi1Cu, GOST AMg5K, UNI G-AlSi7Mg
		N2.2 Odlévané slitiny hliníku s tvrdostí 75–90 HB	0.60	UNS A02420, EN AlCu4Ni2Mg2, SS AlSi7MgFe, BS LM6, STN 424519, UNE Al-7SiMg, AFNOR A-S7G, GOST AK7, UNI G-AlSi7Mg
		N2.3 Odlévané slitiny hliníku s tvrdostí 90 < 140 HB	0.43	UNS A03360, EN G-ALCu4NiMg2, SS AlSi10Mg, STN 424336, BS LM 30, AFNOR A-S10G, UNI G-AlSi9Mg
	N3 Měď nebo slitiny mědi	N3.1 Automatové slitiny mědi s vynikajícími vlastnostmi při obrábění	0.70	UNS C14700, EN CuPb1P, DIN 2.1498, STN 423214, BS C111, AFNOR CuZn35Pb2, GOST L63-3, UNI CuS(P0.01)
		N3.2 Slitiny mědi s krátkou tržskou s dobrými nebo středně dobrými vlastnostmi při obrábění	0.41	UNS C81540, EN CuNi25iCr, DIN 2.0857, STN 423220, BS NS113, UNE CuSn12, AFNOR CuZn40, GOST L60, UNI P-CuZn-40
		N3.3 Elektrolytická měď a slitiny mědi s dlouhou tržskou se středně dobrými až nepříznivými vlastnostmi při obrábění	0.21	UNS C10100, EN CuAg0.1, DIN 2.1203, SS 5010, UNE CUSi3Mn1, AFNOR Cu-C2, GOST M1f, UNI Cu-0F
	N4 Polymery (syntetické nebo polosyntetické materiály)	N4.1 Termoplastické polymery	0.70	ABS, Acryl, Duraplast, Elastomer, EP, Epoxid, FEP, Fluor, Gummi, Kautschuk, Latex, ME, MPF, PA, PAI, PC, PE, PEEK, PEI, PES, PET, PF, Phenolharze, PI, PMMA, Polyamide, Polyester, Polyolefine, Polysulfon, POM, PP, PPE, PPS, PS, PSU, PTFE, PU, PUR, PVDF, SAN, SI, Styrol, UF, Ureol
		N4.2 Termosetové polymery	0.27	Aramid, Epoxy, Fluoropolymer, Methacrylate, Melamine, Phenolic, Polyester, Polyimide, Polymethacrylimide, Polyurethane
		N4.3 Vytužené polymery a kompozity	0.29	CFK, GFK, GMT, Honeycomb, Kevlar, LFT, Organo, SMC
	N5 Grafit	N5.1	1.0	CGM-1, CM-00, GM-10, GM-11, GR030, GR030PI, GR060, GR060PI, GR125, MC-01, MC-01R0, MC-03, MC-03M, IG11, IG-15, IG-32, IG-43, IG-45, IG-70, ISEM-1, ISEM-2, ISEM-3, R8340, R8500X, Technograph 15, Technograph 30, ISO-63, EDM C-3, EDM1, EDM3, ISO-90, ISO-93, ISO-95, R8510, R8650,



SKUPINY MATERIÁLŮ OBROBKŮ (WMG)

Skup. podle ISO	Podskupina	WMG (skupina materiálů obrobků)	k_{wg}	Příklady materiálů (AISI, EN, DIN, ČSN, GB, SS, STN, BS, UNE, AFNOR, ASTM, GOST, UNS, UNI, ...)
S Vysokoteplotní slitiny (superslitiny s vysokou tepelnou odolností a odolností proti korozi převyšující korozivzdornou ocel)	S1 Titan nebo titanové slitiny	S1.1 Titan nebo slitiny titanu, s tvrdostí < 200 HB	1.94	UNS R50250 (Grade 1), EN Ti 99.6, DIN 3.7035, BS TA.2, UNE Ti-Po2, AFNOR T-40, GOST BT1-00, AISI R50250, 3.7025, T35, 2TA1, R50400, 3.7035, 2TAZ,
		S1.2 Slitiny titanu, s tvrdostí 200–280 HB	1.72	UNS R56404 (Grade 29), EN Ti2Cu, DIN 3.7124, BS TA.21, UNE Ti-Pt11, AFNOR T-U2, AISI TA6V, Ti-6Al-4V, Ti 10.2.3, Ti5553
		S1.3 Slitiny titanu, s tvrdostí 280–360 HB	1.44	UNS R54250 (Grade 38), EN TiAl6V4, DIN 3.7165, ČSN TiAl6VELI, BS TA. 13, UNE Ti-P63, AFNOR T-A6V, GOST BT6, AISI TA6V, Ti-6Al-4V, Ti 10.2.3, Ti5553
	S2 Vysokoteplotní slitiny na bázi Fe	S2.1 Vysokoteplotní slitiny na bázi Fe s tvrdostí < 200 HB	1.33	UNS N08801 (Incoloy 801), EN X8 NiCrAlTi31-21, DIN 1.4959, BS NA 15, AFNOR Z8NC33-21, AISI A-286, Discaloy, Haynes 556, Inconel 909, Greek Ascology
		S2.2 Vysokoteplotní slitiny na bázi Fe s tvrdostí 200–280 HB	1.17	UNS N19907, EN X6NiCrTiMoVB25-15-2, DIN 1.4980, SS 2570, BS HR52, AFNOR Z6NCTDV25.15B, GOST 36HXT10, AISI A-286, Discaloy, Haynes 556, Inconel 909, Greek Ascology
		S3.1 Vysokoteplotní slitiny na bázi Ni s tvrdostí < 280 HB	1.00	UNS A09706 (Inconel 706), EN NiCr25FeAl, DIN 2.4856, BS HR 6, ČSN Inconel 625, UNE F.3313, GB 1Cr16Ni35, AFNOR NC22FeDNB, GOST XH38BT, AISI Inconel 718, 706 Waspalloy, Udimet 720, Inconel 625
	S3 Vysokoteplotní slitiny na bázi Ni	S3.2 Vysokoteplotní slitiny na bázi Ni s tvrdostí 280–360 HB	0.83	UNS N07001, EN NiCr20Co13Mo4Ti3Al, DIN 2.4654, BS HR 2, ČSN Waspalloy, AFNOR NCKD 20ATV, GOST XH80T5K0, AISI Inconel 718, 706 Waspalloy, Udimet 720, Inconel 625
		S4 Vysokoteplotní slitiny na bázi Co	S4.1 Vysokoteplotní slitiny na bázi Co s tvrdostí < 240 HB	0.78
	S4.2 Vysokoteplotní slitiny na bázi Co s tvrdostí 240–320 HB		0.67	UNS R30016 (Stellite 6b), EN CoCr20W15Ni, DIN 2.4964, AFNOR KC 20 WN, GOST ЛК52, AISI Haynes 25, Stellite 21, 31



SKUPINY MATERIÁLŮ OBROBKŮ (WMG)

Skup. podle ISO	Podskupina	WMG (skupina materiálů obrobků)	k_{vg}	Příklady materiálů (AISI, EN, DIN, ČSN, GB, SS, STN, BS, UNE, AFNOR, ASTM, GOST, UNS, UNI, ...)
H Kalené materiály (jakýkoli strojírenský kov s tvrdostí > 45 HRC)	H1 Tvrzená litina	H1.1 Tvrzená litina s tvrdostí < 440 HB	1.52	UNS F45001, EN-GJS-1050-6, DIN 5.3406, SS 0512, BS Grade 2A
		H2.1 Kalená litina s tvrdostí < 55 HRC	0.90	UNS F45003, EN-GJS-1400-1, DIN 5.3405, SS 0457, BS Grade 3D
	H2 Kalená litina	H2.2 Kalená litina s tvrdostí > 55 HRC	0.77	UNS F45003, EN G-X260NiCr4-2, DIN 0.9620, SS 0466, BS Grade S
		H3.1 Kalená ocel s tvrdostí < 51 HRC	1.00	AISI 4135, EN 34CrMo4, DIN 1.7220, SS 2234, STN 415131, BS 198, UNE F.1250, GB 35CrMo, AFNOR 35CD4, GOST AC38XTM, UNI 35CrMo4KB
	H3 Kalená ocel < 55 HRC	H3.2 Kalená ocel s tvrdostí 51–55 HRC	0.82	AISI 4135, EN 34CrMo4, DIN 1.7220, SS 2234, STN 415131, BS 198, UNE F.1250, GB 35CrMo, AFNOR 35CD4, GOST AC38XTM, UNI 35CrMo4KB
		H4 Kalená ocel > 55 HRC	H4.1 Kalená ocel s tvrdostí 55–59 HRC	0.64
	H4.2 Kalená ocel s tvrdostí > 59 HRC		0.54	UNS T31501, EN 100MnCrW4, DIN 1.2510, SS 2140, STN 419413, BS B01, UNE F.5220, GB 9CrWMn, AFNOR 90MnWCrV5, GOST 9XBТ, UNI 95MnWCr5KU

45



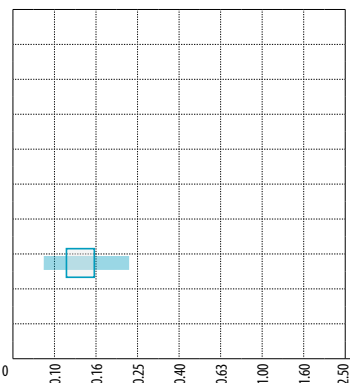

0,15



P	M	K	N	S	H
■	▣	■	■	■	■

Viz diagram





? WCMT 06, WCMX 06

46



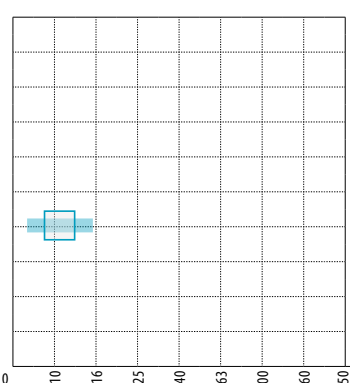

0,1 R1



P	M	K	N	S	H
■	▣	■	■	■	■

Viz diagram



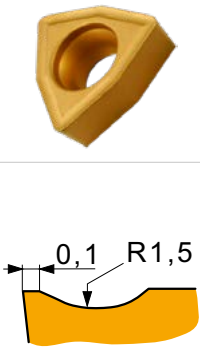

? WCMT 04, WCMX 03, WCMX 04

47



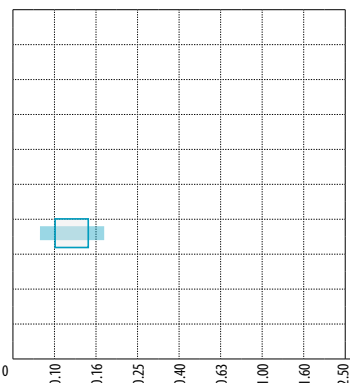

0,1 R1,5



P	M	K	N	S	H
■	▣	■	■	■	■

Viz diagram





? WCMT 05, WCMX 05

48



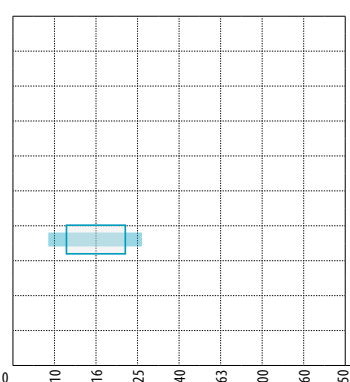

0,1 R2,5



P	M	K	N	S	H
■	▣	■	■	■	■

Viz diagram

? WCMT 08, WCMX 08

GEOMETRIE VRTACÍCH VBD

UM

0,08-0,1
5°
17,5°

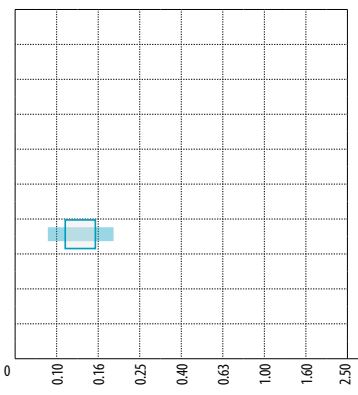
0 0,10 0,16 0,25 0,40 0,63 1,00 1,60 2,50

P **M** **K** **N** **S** **H**

Viz diagram

WCMT 04, WCMT 05

SCET.....-UD

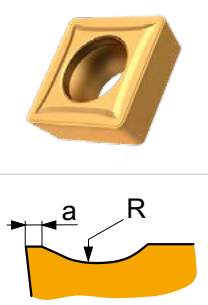
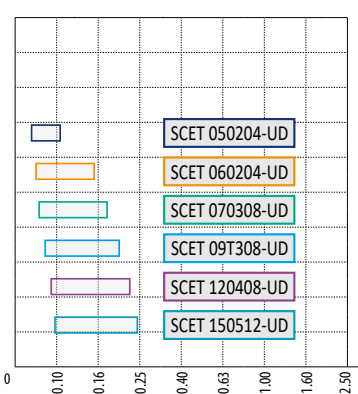
Model	a
SCET 050204-UD	0,12
SCET 060204-UD	0,15
SCET 070308-UD	0,15
SCET 09T308-UD	0,15
SCET 120408-UD	0,20
SCET 150512-UD	0,20

a

SCET 050204-UD 0,12
SCET 060204-UD 0,15
SCET 070308-UD 0,15
SCET 09T308-UD 0,15
SCET 120408-UD 0,20
SCET 150512-UD 0,20

0 0,10 0,16 0,25 0,40 0,63 1,00 1,60 2,50

P **M** **K** **N** **S** **H**

Viz diagram

SCET.....-UD

XPET.....AP

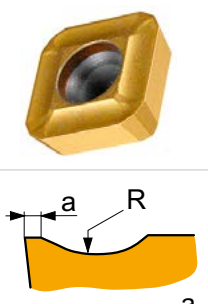
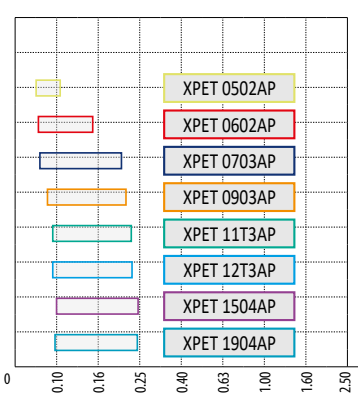
Model	a
XPET 0502AP	0,10
XPET 0602AP	0,10
XPET 0703AP	0,15
XPET 0903AP	0,25
XPET 11T3AP	0,25
XPET 12T3AP	0,25
XPET 1504AP	0,25
XPET 1904AP	0,25

a

XPET 0502AP 0,10
XPET 0602AP 0,10
XPET 0703AP 0,15
XPET 0903AP 0,25
XPET 11T3AP 0,25
XPET 12T3AP 0,25
XPET 1504AP 0,25
XPET 1904AP 0,25

0 0,10 0,16 0,25 0,40 0,63 1,00 1,60 2,50

P **M** **K** **N** **S** **H**

Viz diagram

XPET.....AP

SCET-SD

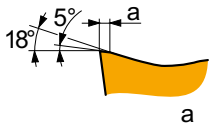

SCET 050204-SD	0,04
SCET 060204-SD	0,06
SCET 070308-SD	0,08
SCET 09T308-SD	0,10
SCET 120408-SD	0,10
SCET 150512-SD	0,10

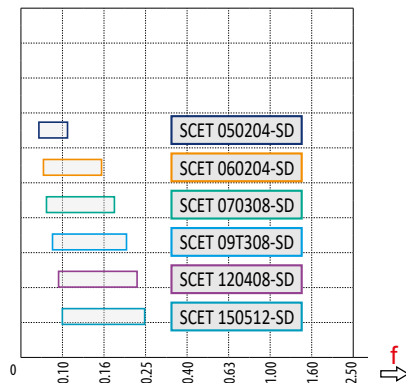

P	M	K	N	S	H
■	■	▣	■	▣	■
f ⇨ Viz diagram					
SCET-SD					

XPETAP-SD

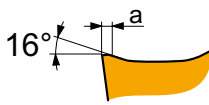

XPET 0502AP-SD	0,04
XPET 0602AP-SD	0,05
XPET 0703AP-SD	0,08
XPET 0903AP-SD	0,10
XPET 11T3AP-SD	0,10
XPET 12T3AP-SD	0,10
XPET 1504AP-SD	0,10
XPET 1904AP-SD	0,12

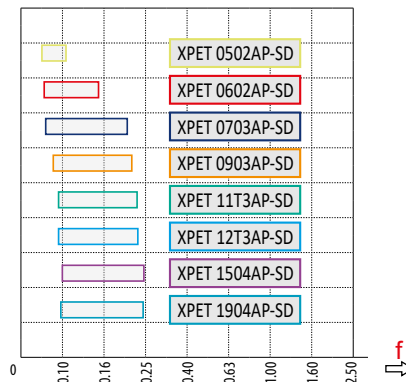

P	M	K	N	S	H
■	■	▣	■	▣	■
f ⇨ Viz diagram					
XPETAP-SD					

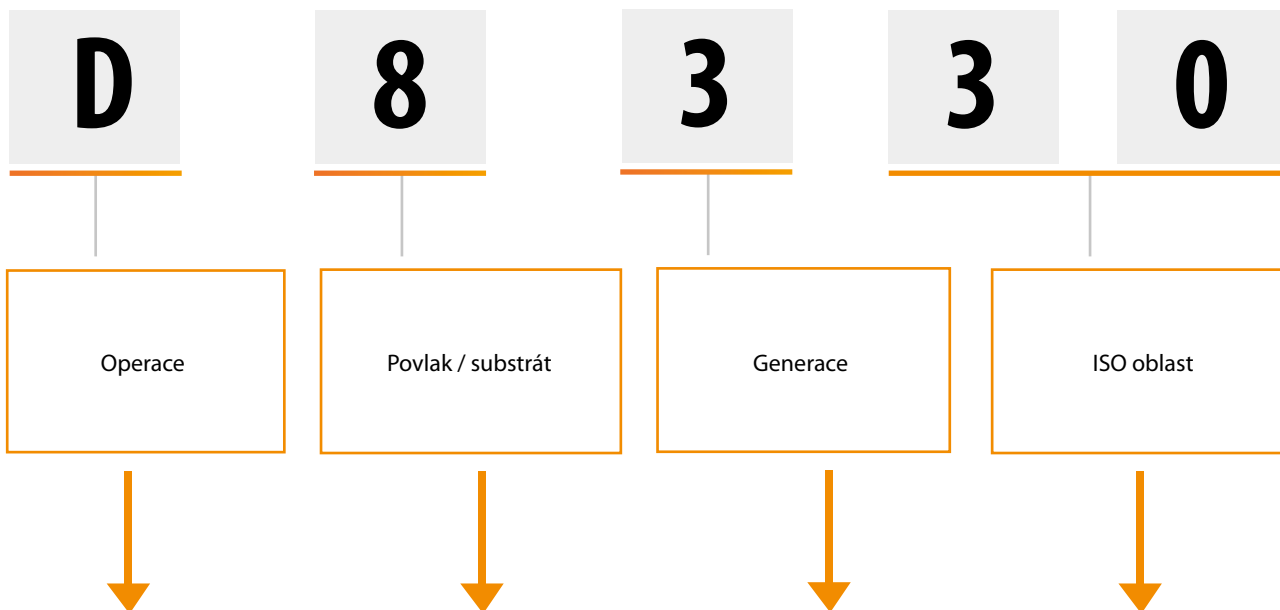

D	Vrtání
M	Frézování
T	Soustružení
G	Zapichování a upichování

0 PVD 1 CVD	Speciální aplikace
2 PVD 3 CVD	Volný
4 PVD 5 CVD	Pro materiály skupiny K, H
6 PVD 7 CVD	Pro materiály skupiny M, S
8 PVD 9 CVD	Univerzální
B	PKBN
C	Keramika
D	PKD
T	Cermet

1 – 9

01 – 50	
	01 – 05
	05 – 10
	10 – 20
	20 – 30
	30 – 40
	40 – 50



VRTACÍ MATERIÁLY

Označení materiálu	Aplikační oblast	Použití	Posuv	řezná rychlost	Odolnost vůči nepříznivým pracovním podmínkám	Povlak	Barva	Substrát	Výhoda chlazení	Popis materiálu
D9335	P20 - P35	■				MT-CVD	■	FGM	+++	Tento materiál se doporučuje u destičkových vrtáků, je vhodnější pro vyšší řezné rychlosti a posuvy.
	M15 - M30	■								
	K15 - K35	■								
	S10 - S20	■								
D8330	P20 - P35	■				PVD	■	submicron H	+++	Jedná se o univerzální materiál pro vnější destičku do destičkových vrtáků, lze ho použít pro většinu materiálů a vyniká provozní spolehlivostí.
	M15 - M30	■								
	K15 - K35	■								
	S10 - S20	■								
D8345	P30 - P50	■				PVD	■	submicron H	+++	Tento materiál je univerzální pro centrální destičku u destičkových vrtáků, je extrémně odolný pro většinu materiálů obrobků.
	M20 - M40	■								
	K30 - K40	■								
	S20 - S30	■								

Substrát

submicron H	Substrát na bázi WC-Co (< 1 mm)
FGM	Funkčně gradientní substrát

Povlak

MT-CVD	Středně teplotní chemická metoda povlakování
PVD	Nízkoteplotní fyzikální metoda povlakování

Výhody řezných kapalin

+++	Použití chladicí kapaliny
-----	---------------------------



DESTIČKOVÉ VRTÁKY – DOPORUČENÉ ŘEZNÉ PODMÍNKY

802D, 803D (XPET..AP, SCET..-UD)



	D9335	D8330	D8345	∅ 15	∅ 20	∅ 25	∅ 30	∅ 40	∅ 58
P1	■	■	■	0.07	0.08	0.09	0.10	0.12	0.16
P2	■	■	■	0.11	0.13	0.15	0.17	0.21	0.28
P3	■	■	■	0.13	0.15	0.18	0.20	0.24	0.32
P4	■	■	■	0.12	0.14	0.16	0.18	0.22	0.30
K1	■	■	■	0.14	0.16	0.19	0.21	0.26	0.34
K2	■	■	■	0.14	0.16	0.19	0.21	0.26	0.34
K3	■	■	■	0.14	0.16	0.19	0.21	0.26	0.34
K4	■	■	■	0.14	0.16	0.19	0.21	0.26	0.34
K5	■	■	■	0.14	0.16	0.19	0.21	0.26	0.34

802D, 803D (XPET..AP-SD, SCET..-SD)



	D9335	D8330	D8345	∅ 15	∅ 20	∅ 25	∅ 30	∅ 40	∅ 58
P1	■	■	■	0.08	0.09	0.10	0.11	0.14	0.18
P2	■	■	■	0.11	0.13	0.15	0.17	0.21	0.28
P3	■	■	■	0.13	0.15	0.18	0.20	0.24	0.32
P4	■	■	■	-	-	-	-	-	-
K1	▣	▣	▣	0.08	0.09	0.10	0.11	0.14	0.18
K2	▣	▣	▣	0.11	0.13	0.15	0.17	0.21	0.28
K3	▣	▣	▣	0.12	0.14	0.16	0.18	0.22	0.24
K4	▣	▣	▣	0.13	0.15	0.18	0.20	0.24	0.32
K5	▣	▣	▣	0.14	0.16	0.19	0.21	0.25	0.33
M1	■	■	■	0.12	0.14	0.16	0.18	0.22	0.30
M2	■	■	■	0.11	0.13	0.15	0.17	0.21	0.28
M3	■	■	■	0.07	0.08	0.09	0.10	0.12	0.16
M4	■	■	■	0.07	0.08	0.09	0.10	0.12	0.16
S1	▣	▣	▣	0.08	0.09	0.10	0.11	0.14	0.18
S2	▣	▣	▣	0.08	0.09	0.10	0.11	0.14	0.18
S3	▣	▣	▣	0.07	0.08	0.09	0.10	0.12	0.16
S4	▣	▣	▣	0.07	0.08	0.09	0.10	0.12	0.16

804D (XPET..AP, SCET..-UD)



	D9335	D8330	D8345	∅ 15	∅ 20	∅ 25	∅ 30	∅ 40	∅ 58
P1	■	■	■	0.06	0.07	0.08	0.09	0.10	0.14
P2	■	■	■	0.10	0.12	0.14	0.16	0.19	0.25
P3	■	■	■	0.12	0.14	0.16	0.18	0.22	0.30
P4	■	■	■	0.11	0.13	0.15	0.17	0.21	0.28
K1	■	■	■	0.13	0.15	0.18	0.20	0.24	0.32
K2	■	■	■	0.13	0.15	0.18	0.20	0.24	0.32
K3	■	■	■	0.13	0.15	0.18	0.20	0.24	0.32
K4	■	■	■	0.13	0.15	0.18	0.20	0.24	0.32
K5	■	■	■	0.13	0.15	0.18	0.20	0.24	0.32



DEŠTIČKOVÉ VRTÁKY – DOPORUČENÉ ŘEZNÉ PODMÍNKY

804D (XPET..AP-SD, SCET..-SD)



	D9335	D8330	D8345	ø 15	ø 20	ø 25	ø 30	ø 40	ø 58
P1	■	■	■	0.07	0.08	0.09	0.10	0.12	0.16
P2	■	■	■	0.10	0.12	0.14	0.16	0.19	0.25
P3	■	■	■	0.12	0.14	0.16	0.18	0.22	0.30
P4	■	■	■	–	–	–	–	–	–
K1	☑	☑	☑	0.07	0.08	0.09	0.10	0.12	0.16
K2	☑	☑	☑	0.10	0.12	0.14	0.16	0.19	0.25
K3	☑	☑	☑	0.11	0.13	0.15	0.17	0.20	0.27
K4	☑	☑	☑	0.12	0.14	0.16	0.18	0.22	0.30
K5	☑	☑	☑	0.14	0.16	0.19	0.21	0.25	0.33
M1	■	■	■	0.11	0.13	0.15	0.17	0.21	0.28
M2	■	■	■	0.10	0.12	0.14	0.16	0.19	0.25
M3	■	■	■	0.06	0.07	0.08	0.09	0.10	0.14
M4	■	■	■	0.06	0.07	0.08	0.09	0.10	0.14
S1	☑	☑	☑	0.07	0.08	0.09	0.10	0.12	0.16
S2	☑	☑	☑	0.07	0.08	0.09	0.10	0.12	0.16
S3	☑	☑	☑	0.06	0.07	0.08	0.09	0.10	0.14
S4	☑	☑	☑	0.06	0.07	0.08	0.09	0.10	0.14

805D (XPET..AP, SCET..-UD)



	D9335	D8330	D8345	ø 15	ø 20	ø 25	ø 30	ø 40	ø 58
P1	■	■	■	0.06	0.07	0.08	0.09	0.10	0.14
P2	■	■	■	0.10	0.12	0.14	0.16	0.19	0.25
P3	■	■	■	0.12	0.14	0.16	0.18	0.22	0.30
P4	■	■	■	0.11	0.13	0.15	0.17	0.21	0.28
K1	■	■	■	0.13	0.15	0.18	0.20	0.24	0.32
K2	■	■	■	0.13	0.15	0.18	0.20	0.24	0.32
K3	■	■	■	0.13	0.15	0.18	0.20	0.24	0.32
K4	■	■	■	0.13	0.15	0.18	0.20	0.24	0.32
K5	■	■	■	0.13	0.15	0.18	0.20	0.24	0.32

805D (XPET..AP-SD, SCET..-SD)



	D9335	D8330	D8345	ø 15	ø 20	ø 25	ø 30	ø 40	ø 58
P1	■	■	■	0.07	0.08	0.09	0.10	0.12	0.16
P2	■	■	■	0.10	0.12	0.14	0.16	0.19	0.25
P3	■	■	■	0.12	0.14	0.16	0.18	0.22	0.30
P4	■	■	■	–	–	–	–	–	–
K1	☑	☑	☑	0.07	0.08	0.09	0.10	0.12	0.16
K2	☑	☑	☑	0.10	0.12	0.14	0.16	0.19	0.25
K3	☑	☑	☑	0.11	0.13	0.15	0.17	0.20	0.27
K4	☑	☑	☑	0.12	0.14	0.16	0.18	0.22	0.30
K5	☑	☑	☑	0.12	0.14	0.16	0.18	0.22	0.30
M1	■	■	■	0.11	0.13	0.15	0.17	0.21	0.28
M2	■	■	■	0.10	0.12	0.14	0.16	0.19	0.25
M3	■	■	■	0.06	0.07	0.08	0.09	0.10	0.14
M4	■	■	■	0.06	0.07	0.08	0.09	0.10	0.14
S1	☑	☑	☑	0.07	0.08	0.09	0.10	0.12	0.16
S2	☑	☑	☑	0.07	0.08	0.09	0.10	0.12	0.16
S3	☑	☑	☑	0.06	0.07	0.08	0.09	0.10	0.14
S4	☑	☑	☑	0.06	0.07	0.08	0.09	0.10	0.14



VZORCE PRO VÝPOČET ŘEZNÝCH PARAMETRŮ

OZNAČENÍ A VZORCE

Parametr	Vzorec	Jednotky
Otáčky	$n = \frac{v_c \cdot 1000}{DC \cdot \pi}$	(ot/min)
Řezná rychlost	$v_c = \frac{\pi \cdot DC \cdot n}{1000}$	(m/min)
Rychlost posuvu	$v_f = n \cdot f$	(mm/min)
Plocha příčného průřezu otvoru	$A = \frac{\pi \cdot DC^2}{4}$	(mm ²)
Objem odebíraného materiálu	$Q = \frac{v_f \cdot A}{1000}$	(cm ³ /min)
Doba obrábění	$T_c = \frac{L + h}{v_f}$	(min/kus)

DC Průměr vrtáku

(mm)

h Bezpečná vzdálenost nájezdu špičky vrtáku od obrobku

(mm)







f Posuv na otáčku

(mm/ot)

L Hloubka otvoru

(mm)

DOPORUČENÉ UTAHOVACÍ MOMENTY ŠROUBKŮ

	 Nm					
US 2245-T07P	0.9	FLAG T07P	M 2.2	5.3	D-T7P	MR-0.8-2.0 vario
US 2205-T07P	0.9	FLAG T07P	M2.2	5.4	D-T7P	MR-0.8-2.0 vario
US 2506-T07P	1.2	FLAG T07P	M 2.5	6	D-T7P	MR-0.8-2.0 vario
US 2507-T08P	1.2	FLAG T08P	M 2.5	7	D-T8P	MR-0.8-2.0 vario
US 3007-T08P	2.0	FLAG T08P	M 3	7	D-T8P	MR-1.0-5.0 vario
US 3007-T09P	2.0	FLAG T09P	M 3	7.4	D-T9P	MR-1.0-5.0 vario
US 3009-T09P	2.0	FLAG T09P	M 3	8.7	D-T9P	MR-1.0-5.0 vario
US 3508-T15P	3.0	FLAG T15P	M 3.5	8.3	D-T15P	MR-1.0-5.0 vario
US 3510-T15P	3.0	FLAG T15P	M 3.5	10.6	D-T15P	MR-1.0-5.0 vario
US 4011-T15P	3.5	FLAG T15P	M 4	10.7	D-T15P	MR-1.0-5.0 vario
US 5012-T15P	5.0	FLAG T15P	M 5	12.2	D-T15P	MR-1.0-5.0 vario



TECHNICKÉ PODMÍNKY PRO VRTÁKY S DESTIČKAMI

Radiální nastavení

Nastavení průměru otvoru a doporučení pro nastavení

Vrtáky s vyměnitelnými destičkami mohou být posunuty mimo střed, aby se docílil menší nebo větší průměr než má skutečný vrták. Hodnoty „Radiálního nastavení“ jsou uvedeny u hlavních rozměrů vrtáků.

Rotující nástroj

Pro přesné nastavení průměru otvoru IT10 se doporučuje nastavitelný upínač při použití nastavitelných vrtáků řady 80xD.

Stacionární nástroj

Při montáži vrtáku se ujistěte, že osa vrtáku je shodná s osou obrobku. Pro dosažení většího průměru otvoru přestavte vrták tak, aby se obvodová destička posunula směrem od osy obrobku.

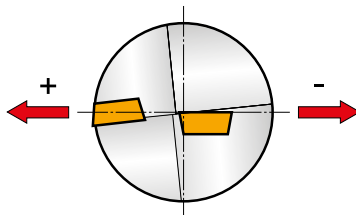

Životnost nástroje

Destičky by se neměly používat při opotřebení hřbetu větším než $0,2 \div 0,4$ mm, měřeno v místě největšího opotřebení.

Doporučené řezné rychlosti, které jsou uvedeny v tomto katalogu, odpovídají životnosti obvodové destičky při vrtání otvoru celkové délky 7 m ($20 \div 30$ min).

EP

NASTAVITELNÉ POUZDRO

Průměr stopky	Průměr vrtáku	Rozsah
25	15 – 24	+0.4 – -0.2
32	24.5 – 40	+0.4 – -0.2

Nastavení průměru pro obráběcí centra

Rozsah nastavení průměru

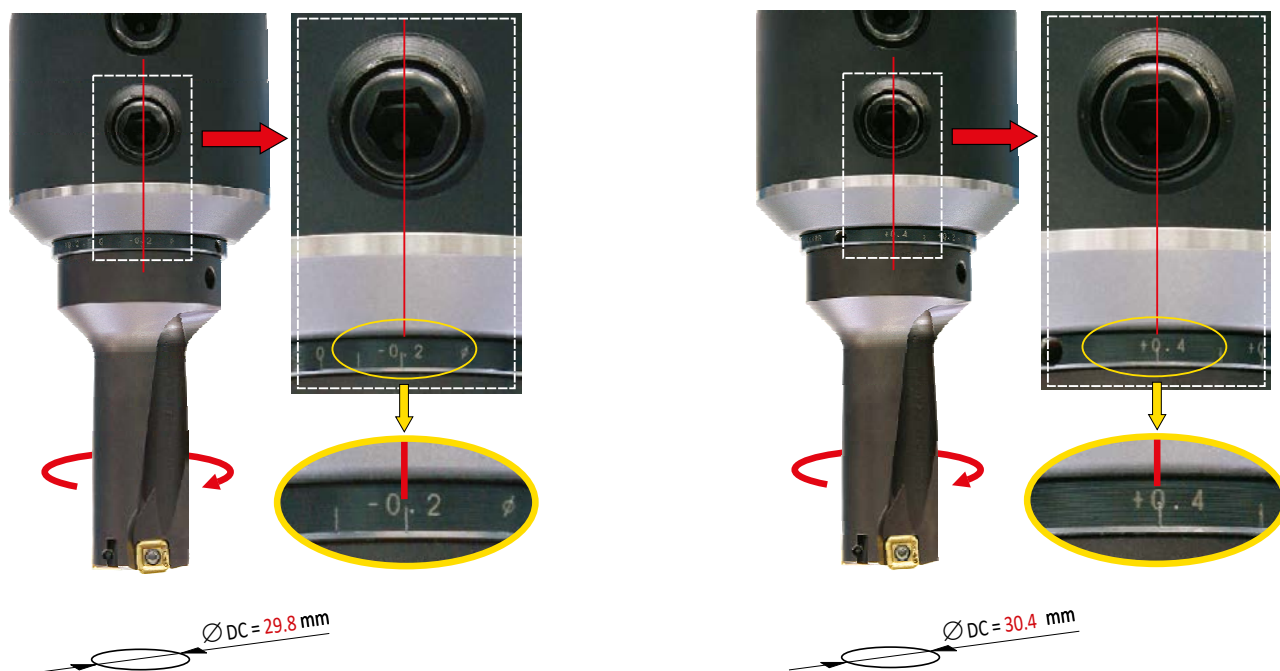



EP

NASTAVITELNÉ POUZDRO

Průměr stopky	Průměr vrtáku	Rozsah
25	15 – 24	+0.2 – -0.15
32	24.5 – 40	+0.2 – -0.15

Nastavení výšky středu
– pro soustružnické operace

Rozsah nastavení výšky středu

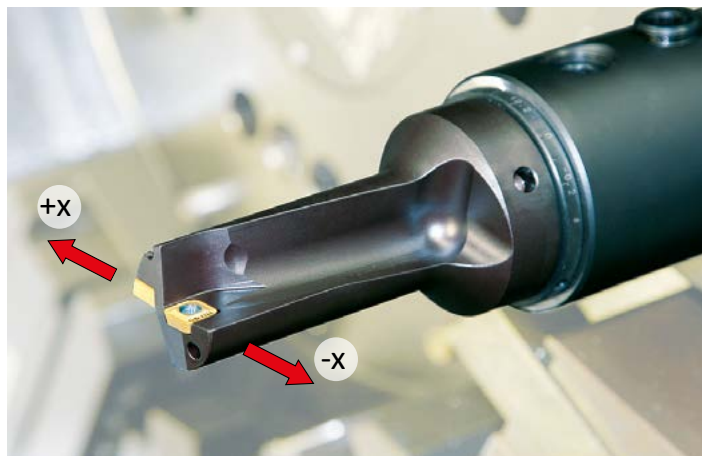

TECHNICKÉ PODMÍNKY PRO VRTÁKY S DESTIČKAMI

Doporučený tlak přiváděné řezné kapaliny

Průměr vrtáku DC (mm)	Tlak řezné kapaliny	
	Délka vrtáku	
	2.0 – 2.5 DC	3.0 – 5.0 DC
15 – 25	6 bar	12 bar
26 – 40	4.5 bar	9 bar
> 40	3 bar	6 bar

Spotřeba chladicí kapaliny

VRTÁNÍ ZA SUCHA

Bez chladicího prostředku (řezné kapaliny) lze vrtat litinu a ocel; je zapotřebí průchod tlakového vzduchu.

Příkon

■ $f \Rightarrow = 0.18$
 ■ $f \Rightarrow = 0.12$
 ■ $f \Rightarrow = 0.08$

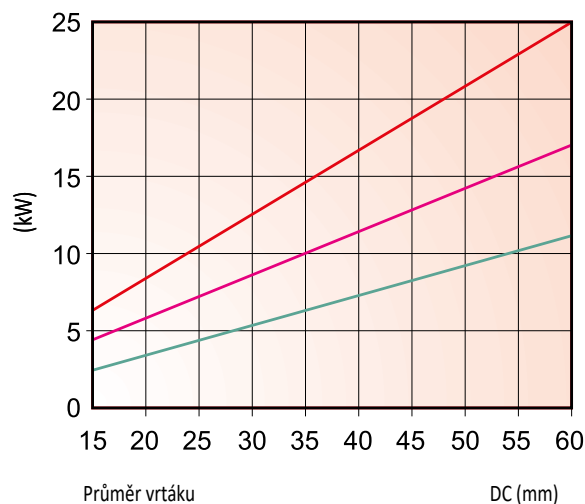
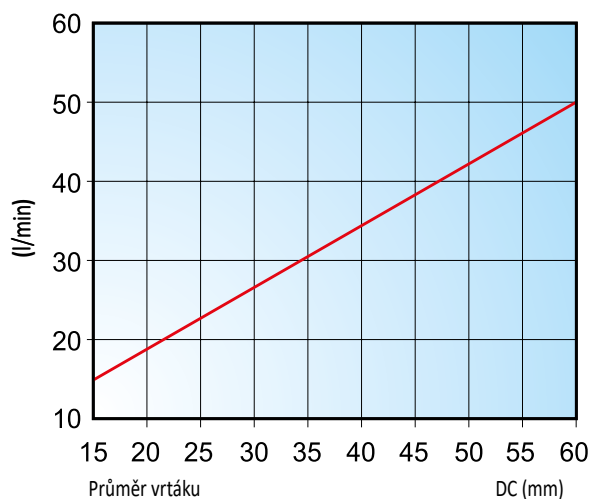

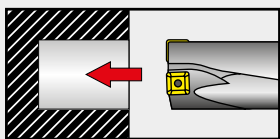

VRTÁNÍ SLEPÉHO OTVORU

Pro vrtání otvorů hlubších než 1D je nezbytné použít vnitřní chlazení.

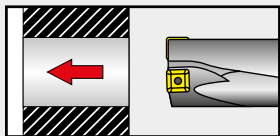

VRTÁNÍ PRŮCHOZÍHO OTVORU

Při vyjíždění destičkového vrtáku z materiálu může být vytvořen kotouč, který může být vymrštěn vysokou rychlostí během obrábění. Je důležitá ochrana strojního zařízení s ohledem na zajištění bezpečnosti obsluhy stroje.

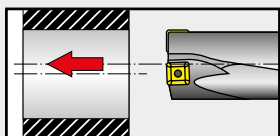

NESOUOSÉ VRTÁNÍ

Snížit posuv na nejnižší doporučenou hodnotu podle destičky. Viz popis destičky v sortimentu vrtáků s destičkami. Nepřekračujte hodnoty radiálního nastavení.

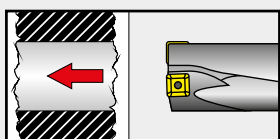

VRTÁNÍ DO NEROVNOMĚRNÉHO A SUROVÉHO POVRCHU

Snížit posuv na 50 % při nájezdu pro daný vrták s destičkami, dokud nejsou obě destičky v záběru.

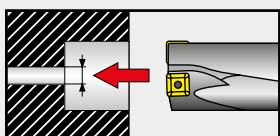

VYVRTÁVÁNÍ A VRTÁNÍ DO PŘEDVRTANÝCH OTVORŮ

Je-li předvrtaná otvor větší než 1/4 průměru vrtáku, snižte posuv.

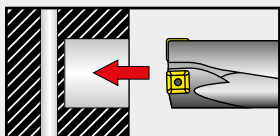

VRTÁNÍ PŘES ŠIKMÝ OTVOR

Snížit posuv na 50 % během vrtání přes šikmý otvor. Průměr existujícího otvoru by neměl být větší než 0,25 x D.

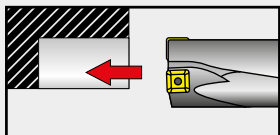

PŘERUŠOVANÝ ŘEZ A ZAPICHOVÁNÍ

Snížit posuv na nejnižší doporučenou hodnotu podle destičky. Viz popis destičky v sortimentu vrtáků s destičkami.

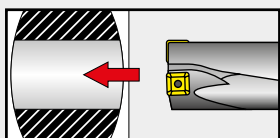

VRTÁNÍ DO ZAKŘIVENÉHO POVRCHU

Vrtání do středové osy zakřiveného povrchu může být provedeno se sníženým posuvem o 50 % při nájezdu a výjezdu z materiálu.

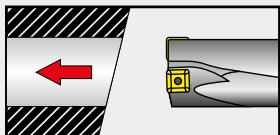

VRTÁNÍ DO ŠIKMÉ PLOCHY

Snížit posuv na 50 % při nájezdu pro daný vrták s destičkami dokud nejsou obě destičky v záběru, jestliže je úhel vstupu větší než 5°.

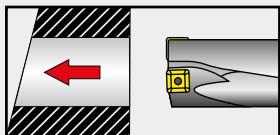

VÝJEZD ZE ŠIKMÉ PLOCHY

Snížit posuv na 50 % při výjezdu, jestliže je úhel výstupu větší než 5°.

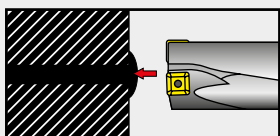

VRTÁNÍ DO SVAROVÉHO SPOJE

Je doporučeno provést zarovnávací povrchu před samotným vrtáním. Snížit posuv na 50 % během vrtání svařovaného materiálu.

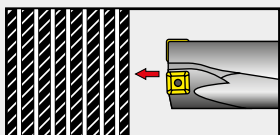

VRTÁNÍ SKLÁDANÝCH MATERIÁLŮ

Vyvarujte se mezer mezi vrstvami větším než 0,2 mm. Součást musí být bezpečně připevněna. Pokud je to nutné, omezte posuv.



ODSTRAŇOVÁNÍ PROBLÉMŮ PŘI VRTÁNÍ - VRTÁKY S DESTIČKAMI

NÍZKÝ VÝKON HNACÍHO MOTORU (NÍZKÝ KROUTÍCÍ MOMENT NA VŘETENU)	<ul style="list-style-type: none">a) snížení řezné rychlosti – snížení otáček vřetenab) snížení posuvu
NADMĚRNÉ OPOTŘEBENÍ BŘITU OBVODOVÉ VBD	<ul style="list-style-type: none">a) snížení řezné rychlostib) volba otěruvzdornějšího druhu materiálu VBDc) zvýšení objemu a tlaku řezné kapaliny
KŘEHKÉ PORUŠENÍ ŘEZNÉ HRANY OBVODOVÉ VBD	<ul style="list-style-type: none">a) snížení posuvu při zavrtávání (zejména u nerovného vstupního povrchu obrobku)b) volba houževnatějšího druhu materiálu VBDc) snížení řezné rychlosti
KŘEHKÉ PORUŠENÍ ŘEZNÉ HRANY VNITŘNÍ VBD	<ul style="list-style-type: none">a) snížení posuvu při zavrtáváníb) přezkontrolovat upnutí vrtáku a obrobku
PLYNULÁ, ŠPATNĚ UTVÁŘENÁ TŘÍSKA	<ul style="list-style-type: none">a) změna posuvub) zvýšit řeznou rychlost při současném snížení posuvu
PĚCHOVÁNÍ KRÁTKÝCH TŘÍSEK V DRÁŽKÁCH PRO OBVOD	<ul style="list-style-type: none">a) zvýšení objemu a tlaku řezné kapalinyb) snížení řezné rychlostic) změna posuvu



DOPORUČENÉ PRŮMĚRY VRTÁKŮ POD ZÁVITY

Metrické závity		Doporučený průměr vrtáku	
Závit	Stoupání	Řezací závitník	Tvářecí závitník
M16 × 1.0	1.00	15.0	15.5
M16 × 0.75	0.75	15.3	–
M17 × 1.0	1.00	16.0	–
M18	2.50	15.5	16.8
M18 × 2.0	2.00	16.0	–
M18 × 1.5	1.50	16.5	17.3
M18 × 1.0	1.00	17.0	–
M20	2.50	17.5	18.8
M20 × 2.0	2.00	18.0	–
M20 × 1.5	1.50	18.5	19.3
M20 × 1.0	1.00	19.0	–
M22	2.50	19.5	20.8
M22 × 2.0	2.00	20.0	–
M22 × 1.5	1.50	20.5	21.3
M22 × 1.0	1.00	21.0	–
M24	3.00	21.0	22.5
M24 × 2.0	2.00	22.0	–
M24 × 1.5	1.50	22.5	23.3
M27	3.00	24.0	–
M27 × 2.0	2.00	25.0	–
M30	3.50	26.5	–
M30 × 2.0	2.00	28.0	–
M33	3.50	29.5	–
M36	4.00	32.0	–
M36 × 3.0	3.00	33.0	–
M39	4.00	35.0	–
M42	4.50	37.5	–
M42 × 3.0	3.00	39.0	–
M45	4.50	40.5	–
M48	5.00	43.0	–
M48 × 3.0	3.00	45.0	–
M52	5.00	47.0	–
M52 × 3.0	3.00	48.0	–

Palcové závity UNC		Doporučený průměr vrtáku	
Závit	Stoupání	Řezací závitník	Tvářecí závitník
3/4"	10	16.7	17.8
7/8"	9	19.5	20.8
1"	8	22.2	23.8
1 1/8"	7	25.0	–
1 1/4"	7	28.2	–
1 3/8"	6	31.0	–
1 1/2"	6	34.0	–
1 3/4"	5	39.5	–
2"	4 1/2	45.2	–
2 1/4"	4 1/2	51.6	–
2 1/2"	4	57.2	–

Whitworthovy závity		Doporučený průměr vrtáku	
Závit	Stoupání	Řezací závitník	Tvářecí závitník
G 3/8"	19	15.3	16.0
G 1/2"	14	19.0	20.0
G 5/8"	14	21.0	22.0
G 3/4"	14	24.5	25.5
G 7/8"	14	28.3	29.3
G 1"	11	30.8	32.0
G 1 1/8"	11	35.5	–
G 1 1/4"	11	39.5	–
G 1 3/8"	11	41.8	–
G 1 1/2"	11	45.3	–
G 1 3/4"	11	51.0	–
G 2"	11	57.0	–

Palcové závity UNF		Doporučený průměr vrtáku	
Závit	Stoupání	Řezací závitník	Tvářecí závitník
3/4"	16	17.5	18.3
7/8"	14	20.5	21.3
1"	12	23.4	24.3
1 1/8"	12	26.5	–
1 1/4"	12	29.8	–
1 3/8"	12	33.0	–
1 1/2"	12	36.0	–



VYVRTÁVACÍ SYSTEMY





VÝROBA OTVORŮ – OBSAH

6		WMG A ISO 13399
12	MONOLITNÍ VRTÁKY	NÁVOD
15		MONOLITNÍ KARBIDOVÉ VRTÁKY
66		HSS VRTÁKY
176		ŘEZNÉ KAPALINY
186		TECHNICKÉ INFORMACE
190		VÝSTRUŽNÍKY A ZÁHLUBNÍKY
264	DESTIČKOVÉ VRTÁKY	NÁVOD
271		VRTÁKY HYDRA
297		TECHNICKÉ INFORMACE
307		DESTIČKOVÉ VRTÁKY
327		TECHNICKÉ INFORMACE
350	VYVRTÁVACÍ SYSTÉMY	NÁVOD
359		VYVRTÁVACÍ HLAVY
376		PŘÍSLUŠENSTVÍ PRO VYVRTÁVÁNÍ
381		BŘITOVÉ DESTIČKY
404		UPÍNACÍ TRNY
418		VYVRTÁVACÍ SADY
429		TECHNICKÉ INFORMACE



BŘITOVÉ DESTIČKY – PŘEHLED STRÁNKY



1 CCGT

	IC (mm)	D1 (mm)	L (mm)	S (mm)
0602	6.350	2.80	6.40	2.38
0602-SF3	6.350	2.80	6.40	2.58
0803-AL	7.940	3.40	8.10	3.43
0803-SF3	7.940	3.40	8.10	3.43
09T3	9.525	4.40	9.70	3.97
09T3-SF3	9.525	4.40	9.70	4.22
1204	12.700	5.50	12.90	4.76
1204-SF3	12.700	5.50	12.90	5.01

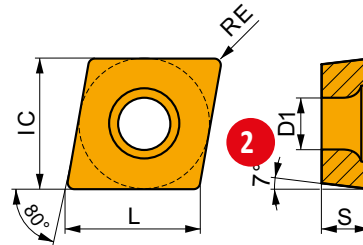

Vhodné startovací podmínky pro řeznou rychlost (Vc), posuv (f) a hloubka řezu (Ap). Další výpočty naleznete v naší aplikaci Kalkulátor řezných podmínek.

Product	RE (mm)	P			M			K			N			S			H		
		vc [m/min]	f [mm/rev]	ap [mm]	vc [m/min]	f [mm/rev]	ap [mm]	vc [m/min]	f [mm/rev]	ap [mm]	vc [m/min]	f [mm/rev]	ap [mm]	vc [m/min]	f [mm/rev]	ap [mm]	vc [m/min]	f [mm/rev]	ap [mm]

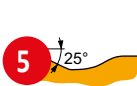

10 AL je vysoce pozitivní geometrie pro obrábění na čisto i hrubování, čistý i přerušovaný řez.

CCGT 060202F-AL	HF7	0.2	-	-	-	-	-	-	-	360	0.12	1.0	-	-	-	-	-	-
CCGT 060204F-AL	T0315	0.4	-	-	-	-	-	-	-	300	0.24	1.0	-	-	-	-	-	-
CCGT 080302F-AL	T0315	0.2	-	-	-	-	-	-	-	360	0.12	1.0	-	-	-	-	-	-
CCGT 080304F-AL	HF7	0.4	-	-	-	-	-	-	-	300	0.24	1.0	-	-	-	-	-	-
	T0315	0.4	-	-	-	-	-	-	-	300	0.24	1.0	-	-	-	-	-	-
CCGT 09T302F-AL	HF7	0.2	-	-	-	-	-	-	-	360	0.12	1.0	-	-	-	-	-	-
	T0315	0.2	-	-	-	-	-	-	-	360	0.12	1.0	-	-	-	-	-	-
CCGT 09T304F-AL	HF7	0.4	-	-	-	-	-	-	-	300	0.24	1.5	-	-	-	-	-	-
	T0315	0.4	-	-	-	-	-	-	-	300	0.24	1.5	-	-	-	-	-	-
CCGT 09T308F-AL	HF7	0.8	-	-	-	-	-	-	-	200	0.48	1.5	-	-	-	-	-	-
	T0315	0.8	-	-	-	-	-	-	-	200	0.48	1.5	-	-	-	-	-	-
CCGT 120404F-AL	HF7	0.4	-	-	-	-	-	-	-	300	0.24	2.4	-	-	-	-	-	-
	T0315	0.4	-	-	-	-	-	-	-	300	0.24	2.4	-	-	-	-	-	-
CCGT 120408F-AL	HF7	0.8	-	-	-	-	-	-	-	200	0.48	2.4	-	-	-	-	-	-
	T0315	0.8	-	-	-	-	-	-	-	200	0.48	2.4	-	-	-	-	-	-

CCGT120404F-AL:T0315 Při objednávce použijte celý kód specifikace destičky!

Materiál

Zahrňte dvojtečku

Kód břitové destičky
ISO



BŘITOVÉ DESTIČKY – PŘEHLED STRÁNKY

Poz.	Popis	Poz.	Popis
1	Označení destičky	7	Kód břitové destičky ISO
2	Schematické vyobrazení destičky	8	Materiál
3	Tabulka s velikostmi destiček (mm)	9	Rádus destičky (mm)
4	Obrázek znázornění destičky	10	Popis geometrie
5	Profil hlavní řezné hrany	11	Aplikační oblast destičky
6	Ikony – konkrétní vlastnosti a typ řezné hrany		

1 D75-BB

P M K N S H **2**

PRAMET **3 S(P)**



Hrubovací vyvrtávací hlava 75° pro Ø220 - Ø500 mm

Vyvrtávací hlava 75° pro hrubovací operace. Vhodná pro vyvrtávání v průchozích i slepých otvorech a srážení hran spirálovou interpolací. Vhodné pro destičky typu CC..., TC..., CN... a rozsah průměrů Ø220 - Ø500 mm. CZC MS - velikost upínače 300 - 500. Vysoká přesnost a opakovatelnost procesu. **5**

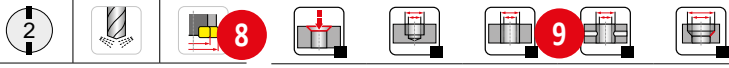
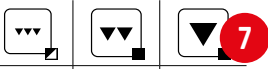
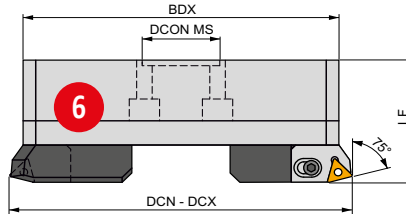

Product	CZC MS	DCN	DCX	BDX	DCON MS	LF										
		(mm)	(mm)	(mm)	(mm)	(mm)										
D 30075 300	300	220.00	320.00	202	60.00	90.00	3CT 75 300	US 0625	HXK 5	TC.. 16T3..	US 0415-T15P	SDR T15P	HXK 5	HXK 4	9.40	
D 30075 402	300	220.00	320.00	202	60.00	90.00	3CT 75 402	US 0625	HXK 5	CC.. 1204..	US 0513-T20P	SDR T20P	HXK 5	HXK 4	9.37	
D 30075 402N	300	220.00	320.00	202	60.00	90.00	3CT 75 402 N	US 0625	HXK 5	CN.. 1204..	US 0613-H25	HXK 2.5	HXK 5	HXK 4	9.37	
D 40075 300	400	290.00	400.00	272	60.00	90.00	3CT 75 300 N	US 0625	HXK 5	CM.. 16T4..	US 0415-T15P	SDR T15P	HXK 5	HXK 4	9.40	
D 40075 402	400	290.00	400.00	272	60.00	90.00	3CT 75 402 N	US 0625	HXK 5	CM.. 1204..	US 0513-T20P	SDR T20P	HXK 5	HXK 4	9.37	
D 40075 402N	400	290.00	400.00	272	60.00	90.00	3CT 75 402 N	US 0625	HXK 5	CM.. 1204..	US 0613-H25	HXK 2.5	HXK 5	HXK 4	9.37	

1 69871-BS

PRAMET



Upínač vyvrtávacích hlav se stopkou DIN 69871

Tuhý upínač se stopkou DIN 69871 SK30, 40 a 50, určený pro vyvrtávací hlavy. Dostupné jsou různé délkové varianty. Otvor pro spojení velikosti 22 - 160 mm může být použit v kombinaci s prodloužením EXT-BS, redukcí RED-BS nebo spojkovým prodloužením LA-BS. Možnost vnitřního chlazení. Pro aplikace vyžadující přesnost a opakovatelnost procesu. **5**

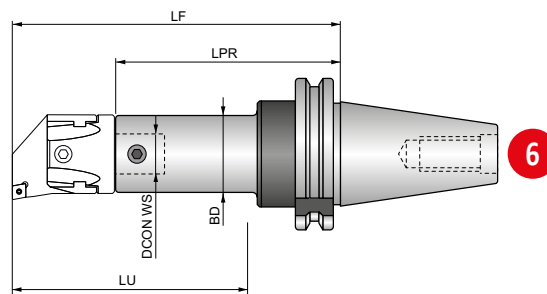

Product		CZC MS	BD	DCON WS	LF	LPR	LU				
			(mm)	(mm)	(mm)	(mm)	(mm)				
AS 330 022 100 R		30	22	22.00	12.00	138.00	104	100.00	✓	US 0608	0.72
AS 330 027 055 R		30	27	27.00	15.00	90.00	48	55.00	✓	US 0609	0.56
AS 330 027 100 R		30	27	27.00	15.00	138.00	96	100.00	✓	US 0609	0.68
AS 330 060 R	10	24	11	32.00	20.00	12	51	60.00	22	23	21
AS 330 100 R				32.00	20.00		93	100.00			
AS 340 022 080 R		40	22	22.00	12.00	118.00	84	80.00	✓	US 0608	1.14



VYVRTÁVACÍ NÁSTROJE A UPÍNAČE – ORIENTACE NA STRÁNCE

Poz.	Označení	Poz.	Označení
1	Označení nástroje/upínače	13	Kazeta
2	Skupiny materiálů, pro které je nástroj určen	14	Šroub kazety
3	Upínací systém destičky	15	Klíč šroubu kazety
4	Ilustrační foto	16	Skupina kompatibilních destiček
5	Popis nástroje/upínače	17	Šroub destičky
6	Schematické vyobrazení nástroje/upínače	18	Klíč šroubu destičky
7	Dosažitelná kvalita povrchu	19	Seřizovací klíč hlavy
8	Obecné vlastnosti nástroje	20	Zajišťovací klíč hlavy
9	Technologické možnosti nástroje	21	Hmotnost (kg)
10	Kód nástroje/upínače ¹⁾	22	Interní přívod chladicí kapaliny
11	Kód velikosti hlavy/upínače ²⁾	23	Upínací šroub hlavy
12	Rozměry nástroje/upínače [mm]	24	Velikost upínače ³⁾

¹⁾ Popis kódu nástroje je obsažen v technické části

²⁾ Hlava a upínač musí mít vždy stejný kód, aby byla zajištěna jejich kompatibilita

³⁾ Typ upínacího kužele viz schématický obrázek



KNIHOVNA OBRÁBĚNÝCH MATERIÁLŮ

Obrábění oceli, nerezové oceli, litiny, superslitin nebo neželezných materiálů, to vše je zahrnuto v naší aplikaci Kalkulátor. Stáhněte si ji ještě dnes z Vašeho App Store. **Jsme jednoduše spolehliví.**

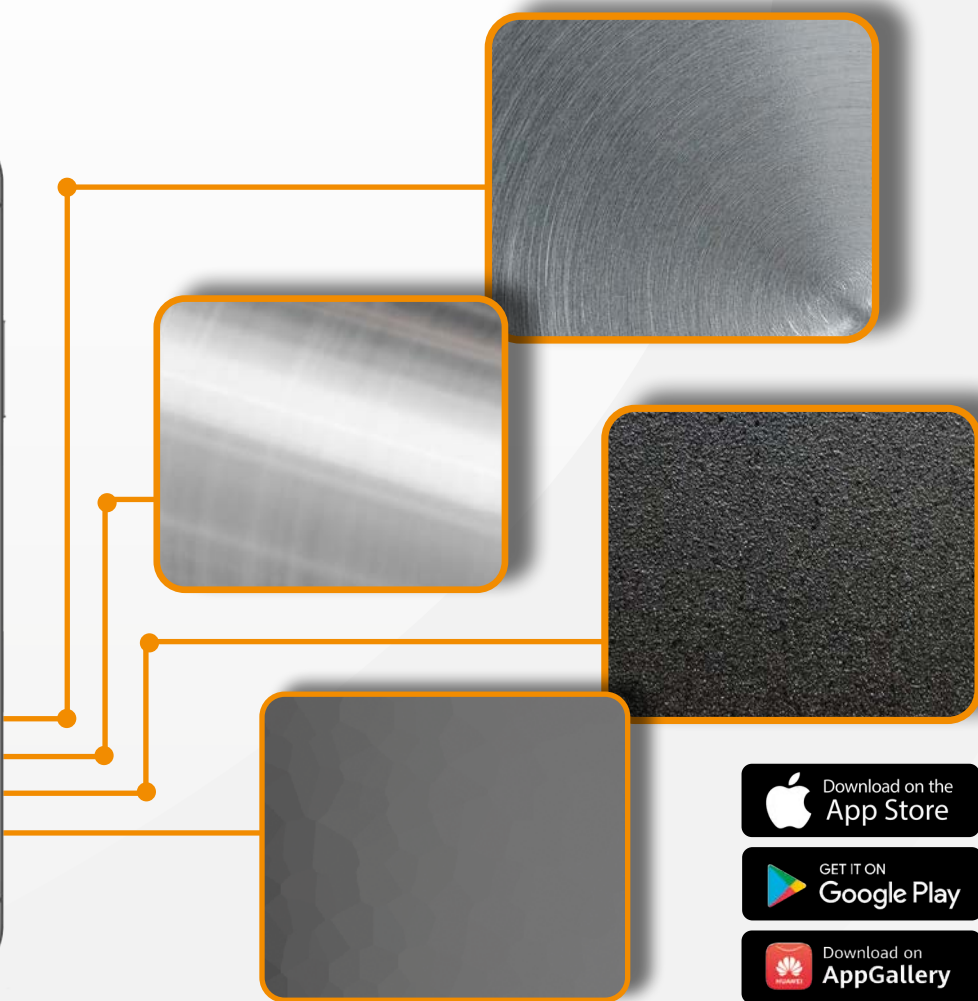
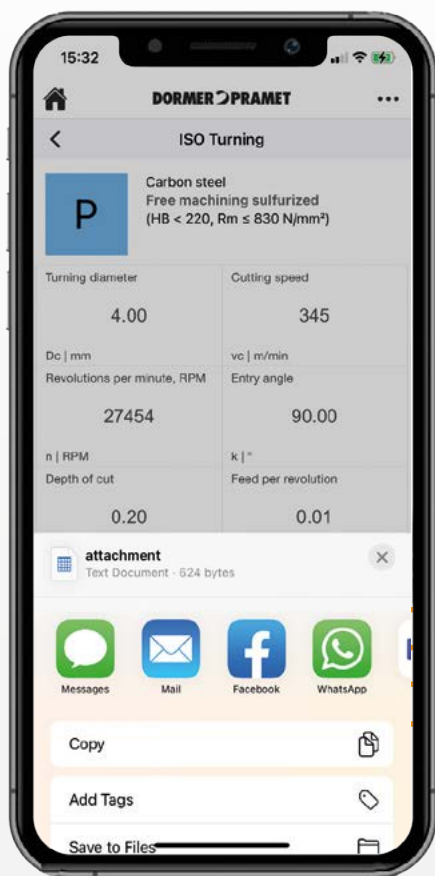



VYVRTÁVÁNÍ – PŘEHLED IKON

OBECNÉ IKONY

	Hlavní použití		Dokončování – velmi dobrá kvalita povrchu		Hrubování – neomezená drsnost povrchu
	Podmíněné použití		Střední obrábění – dobrá kvalita povrchu		

OBECNÉ VLASTNOSTI NÁSTROJŮ

	1 efektivní zub na otáčku		Nastavitelný průměr nástroje
	Dva efektivní zuby na otáčku		

TECHNOLOGICKÉ MOŽNOSTI NÁSTROJE

	Vyrtávání slepého otvoru		Vyrtávání do rohu		Srážení hran (zkosení) v otvorech
	Vyrtávání přes příčné otvory		Srážení hran (zkosení)		Vyrtávání průchozích otvorů

VLASTNOSTI

	První volba		Vysokorychlostní řezání		Hrana s fazetkou
	Pro materiály s krátkou třískou		Velké vyložení		Zaoblená hrana s fazetkou
	Pro houževnaté materiály (dlouhá tříska)		Tenkostěnné a štíhlé obrobky		Zaoblená hrana s dvojitou fazetkou
	Obtížné pracovní podmínky		Univerzální možnost širokého rozsahu		Zaoblená hrana s fazetkou
					Ostrá hrana

JINÉ





	Velikost kužele
--	-----------------

TECHNICKÁ ČÁST

	Posuv (mm/ot)		Střední řezná rychlost, snížená tuhost soustavy (mírně přerušovaný řez)
	Velmi vysoká řezná rychlost, excelentní tuhost soustavy (stabilní záběrové podmínky)		Nízká řezná rychlost, nízká tuhost soustavy (přerušovaný řez)
	Vysoká řezná rychlost, dobrá tuhost soustavy (stabilní záběrové podmínky)		Nízká řezná rychlost, velmi nízká tuhost soustavy (velmi špatné záběrové podmínky)
	Vyšší řezná rychlost, mírně snížená tuhost soustavy (kolísavá hloubka řezu)		



SYSTÉM VYVRTÁVÁNÍ – NAVIGÁTOR



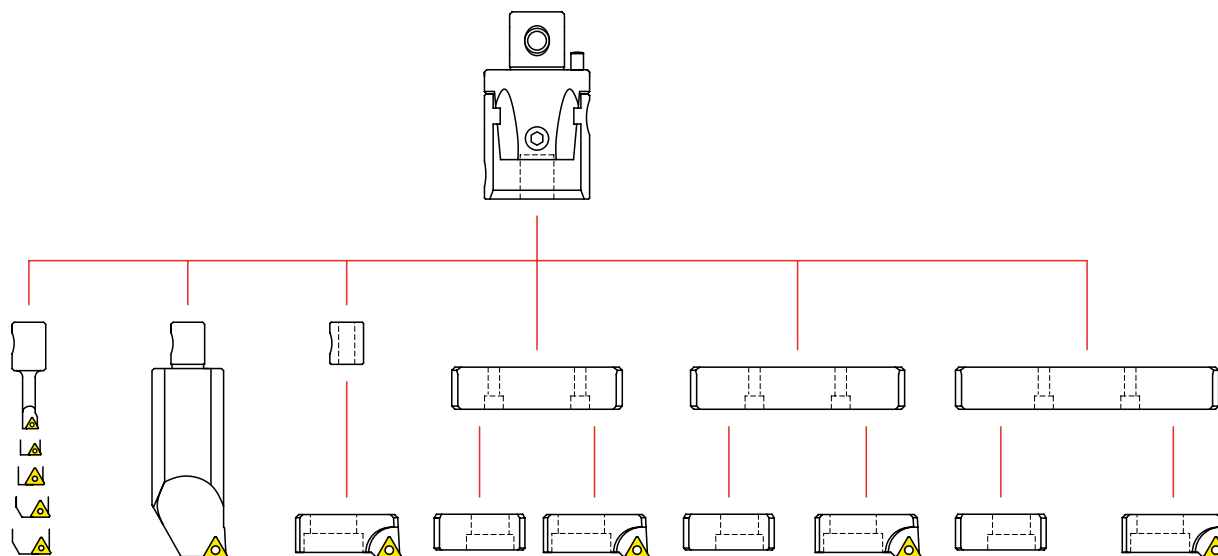

	HRUBOVACÍ HLAVY		
			
Označení nástroje	D75 / D90	D75-C/D90-C	D75-BB/D90-BB
Rozsah vyvrtávání	24 – 82	80 – 220	220 – 500
Přesnost otvoru	IT9	IT9	IT9
Max. hloubka vrtání	5×D	4×D	360 mm
Úhel nastavení	75° / 90°	75° / 90°	75° / 90°
Přesnost nastavení (mm/Ø)	–	–	–
	361, 364	362, 365	363, 366

VYVRTÁVACÍ KITY – 420 – 427













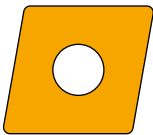

SYSTEM VYVRTÁVÁNÍ – NAVIGÁTOR

DOKONČOVACÍ HLAVY			MIKRO HLAVY	
				
F75/F90	F75-C/F90-C	F75-BB/F90-BB	MB-H	
24 – 82	80 – 220	220 – 500	8 – 38	
IT7	IT7	IT7	IT6	
5×D	4×D	–	104 mm	
75° / 90°	75° / 90°	75° / 90°	–	
0.002	0.002	0.002	0.002	
367, 370	368, 371	369, 372	373	

PŘÍSLUŠENSTVÍ VYVRTÁVACÍCH HLAV

ISO BARS	ISO BARS A042	CHAM-BS	CART-BS	VBD
				
 374	 375	 380	 378	 388



SYSTÉM VYVRTÁVÁNÍ – NAVIGÁTOR

UPÍNAČE

69871-BS ISO 30, 40, 50	BT-BS ISO 30, 40, 50	HSK-BS 50A, 63A, 100A	2080-BS ISO 40, 50	MOR-BS MORSE	WEL-BS WELDON
406	408	410	411	413	414

PŘÍSLUŠENSTVÍ UPÍNAČŮ

EXT-BS	RED-BS	LA-BS
415	416	417

VYVRTÁVACÍ KITY – 420 – 427





VYVRTÁVACÍ HLAVY



VYVRTÁVACÍ HLAVY – OZNAČENÍ

1	2	3	4
D	042	75	402N

1		2		3		4	
Druh nástroje		Velikost hlavy		Úhel nastavení		Typ VBD	
D	Hrubování	022	75	300	TC..16T3.		
		027	90	400	CC..0602..		
		032		401	CC..0803..		
		042		402	CC..1204..		
A	Dokončování	054		409	CC..09T3..		
		068		402N	CN..1204..		
		085					
		100					
		200					
		300					
		400					
		500					

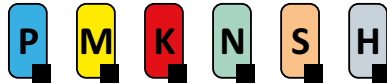
**D75****PRAMET****S(P)****Hrubovací vyvrtávací hlava 75° pro Ø24 - Ø82 mm**

Vyvrtávací hlava 75° pro hrubovací operace. Vhodná pro vyvrtávání v průchozích i slepých otvorech srážení hran spirálovou interpolací. Vhodné pro destičky typu CC..., TC..., CN... a rozsah průměrů Ø24 - Ø82 mm. CZC MS - velikost upínače 22 - 54. Vysoká přesnost a opakovatelnost procesu.

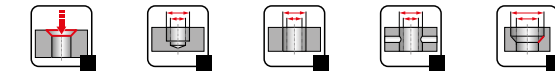
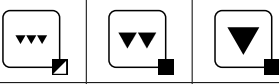
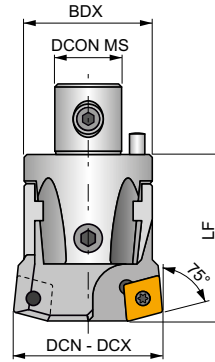

Produkt	CZC MS	DCN	DCX	BDX	DCON MS	LF						
												(mm)
D 02275 400	22	24.00	30.00	22	12.00	34.00	CC.. 0602..	US 0206-T08P	SDR T08P	HXK 2	HXK 3	0.10
D 02775 401	27	29.00	40.00	27	15.00	42.00	CC.. 0803..	US 0307-T10P	SDR T10P	HXK 2	HXK 4	0.17
D 02775 409	27	29.00	40.00	27	15.00	42.00	CC.. 09T3..	US 0408-T15P	SDR T15P	HXK 2	HXK 4	0.17
D 03275 401	32	39.00	50.00	32	20.00	45.00	CC.. 0803..	US 0307-T10P	SDR T10P	HXK 2.5	HXK 4	0.27
D 03275 409	32	39.00	50.00	32	20.00	45.00	CC.. 09T3..	US 0408-T15P	SDR T15P	HXK 2.5	HXK 4	0.27
D 04275 300	42	49.00	65.00	42	24.00	56.00	TC.. 16T3..	US 0415-T15P	SDR T15P	HXK 3	HXK 5	0.54
D 04275 402	42	49.00	65.00	42	24.00	56.00	CC.. 1204..	US 0513-T20P	SDR T20P	HXK 3	HXK 5	0.54
D 04275 402N	42	53.00	65.00	42	24.00	56.00	CN.. 1204..	US 0613-H25	HXK 2.5	HXK 3	HXK 5	0.53
D 05475 300	54	63.00	82.00	54	28.00	66.00	TC.. 16T3..	US 0415-T15P	SDR T15P	HXK 3	HXK 6	1.07
D 05475 402	54	63.00	82.00	54	28.00	66.00	CC.. 1204..	US 0513-T20P	SDR T20P	HXK 3	HXK 6	1.07
D 05475 402N	54	63.00	82.00	54	28.00	66.00	CN.. 1204..	US 0613-H25	HXK 2.5	HXK 3	HXK 6	1.03



D75-C

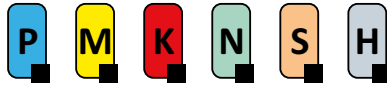

PRAMET

S(P)



Hrubovací vyvrtávací hlava 75° pro Ø80 - Ø220 mm

Vyvrtávací hlava 75° pro hrubovací operace. Vhodná pro vyvrtávání v průchozích i slepých otvorech a srážení hran spirálovou interpolací. Vhodné pro destičky typu CC..., TC..., CN... a rozsah průměrů Ø80 - Ø220 mm. CZC MS - velikost upínače 68 - 200. Vysoká přesnost a opakovatelnost procesu.

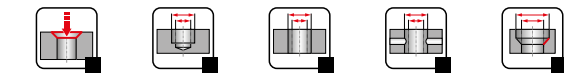
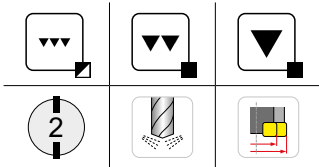
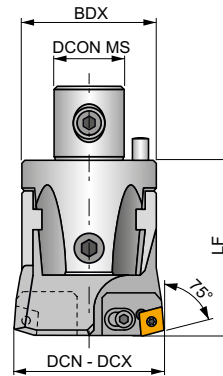

Produkt	CZC MS	DCN	DCX	BDX	DCON MS	LF											
		(mm)	(mm)	(mm)	(mm)	(mm)											
D 06875 300	68	80.00	102.00	68	36.00	86.00	2CT 75 300	US 0616	HXK 5	TC.. 16T3..	US 0408-T15P	SDRT15P	HXK 4	HXK 8			2.16
D 06875 402	68	80.00	102.00	68	36.00	86.00	2CT 75 402	US 0616	HXK 5	CC.. 1204..	US 0509-T20P	SDRT20P	HXK 4	HXK 8			2.15
D 06875 402N	68	80.00	102.00	68	36.00	86.00	2CT 75 402 N	US 0616	HXK 5	CN.. 1204..	US 0613-H25	HXK 2.5	HXK 4	HXK 8			2.21
D 08575 300	85	100.00	125.00	85	50.00	100.00	3CT 75 300	US 0625	HXK 5	TC.. 16T3..	US 0415-T15P	SDRT15P	HXK 5	HXK 8			4.16
D 08575 402	85	100.00	125.00	85	50.00	100.00	3CT 75 402	US 0625	HXK 5	CC.. 1204..	US 0513-T20P	SDRT20P	HXK 5	HXK 8			4.13
D 08575 402N	85	100.00	125.00	85	50.00	100.00	3CT 75 402 N	US 0625	HXK 5	CN.. 1204..	US 0613-H25	HXK 2.5	HXK 5	HXK 8			4.23
D 10075 300	100	125.00	160.00	110	60.00	100.00	3CT 75 300	US 0625	HXK 5	TC.. 16T3..	US 0415-T15P	SDRT15P	HXK 5	HXK 8			6.57
D 10075 402	100	125.00	160.00	110	60.00	100.00	3CT 75 402	US 0625	HXK 5	CC.. 1204..	US 0513-T20P	SDRT20P	HXK 5	HXK 8			6.55
D 10075 402N	100	125.00	160.00	110	60.00	100.00	3CT 75 402 N	US 0625	HXK 5	CN.. 1204..	US 0613-H25	HXK 2.5	HXK 5	HXK 8			6.57
D 20075 300	200	160.00	220.00	145	60.00	100.00	3CT 75 300	US 0625	HXK 5	TC.. 16T3..	US 0415-T15P	SDRT15P	HXK 5	HXK 8			8.87
D 20075 402	200	160.00	220.00	145	60.00	100.00	3CT 75 402	US 0625	HXK 5	CC.. 1204..	US 0513-T20P	SDRT20P	HXK 5	HXK 8			8.88
D 20075 402N	200	160.00	220.00	145	60.00	100.00	3CT 75 402 N	US 0625	HXK 5	CN.. 1204..	US 0613-H25	HXK 2.5	HXK 5	HXK 8			8.95



D75-BB

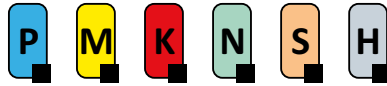

Hrubovací vyvrtávací hlava 75° pro Ø220 - Ø500 mm

Vyvrtávací hlava 75° pro hrubovací operace. Vhodná pro vyvrtávání v průchozích i slepých otvorech a srážení hran spirálovou interpolací. Vhodné pro destičky typu CC..., TC..., CN... a rozsah průměrů Ø220 - Ø500 mm. CZC MS - velikost upínače 300 - 500. Vysoká přesnost a opakovatelnost procesu.

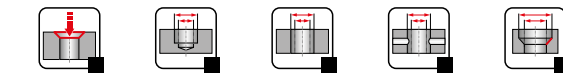
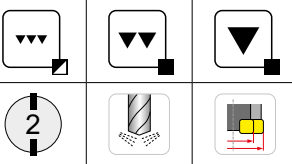
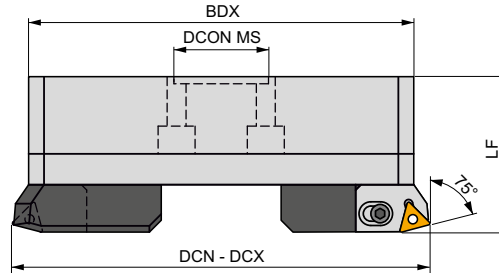

Produkt	CZC MS	DCN	DCX	BDX	DCON MS	LF										
		(mm)	(mm)	(mm)	(mm)	(mm)										kg
D 30075 300	300	220.00	320.00	202	60.00	90.00	3CT 75 300	US 0625	HXK 5	TC.. 16T3..	US 0415-T15P	SDRT15P	HXK 5	HXK 4	9.40	
D 30075 402	300	220.00	320.00	202	60.00	90.00	3CT 75 402	US 0625	HXK 5	CC.. 1204..	US 0513-T20P	SDRT20P	HXK 5	HXK 4	9.37	
D 30075 402N	300	220.00	320.00	202	60.00	90.00	3CT 75 402 N	US 0625	HXK 5	CN.. 1204..	US 0613-H25	HXK 2.5	HXK 5	HXK 4	9.37	
D 40075 300	400	290.00	400.00	272	60.00	90.00	3CT 75 300	US 0625	HXK 5	TC.. 16T3..	US 0415-T15P	SDRT15P	HXK 5	HXK 4	12.92	
D 40075 402	400	290.00	400.00	272	60.00	90.00	3CT 75 402	US 0625	HXK 5	CC.. 1204..	US 0513-T20P	SDRT20P	HXK 5	HXK 4	12.95	
D 40075 402N	400	290.00	400.00	272	60.00	90.00	3CT 75 402 N	US 0625	HXK 5	CN.. 1204..	US 0613-H25	HXK 2.5	HXK 5	HXK 4	12.98	
D 50075 300	500	370.00	500.00	352	60.00	90.00	3CT 75 300	US 0625	HXK 5	TC.. 16T3..	US 0415-T15P	SDRT15P	HXK 5	HXK 4	16.74	
D 50075 402	500	370.00	500.00	352	60.00	90.00	3CT 75 402	US 0625	HXK 5	CC.. 1204..	US 0513-T20P	SDRT20P	HXK 5	HXK 4	16.74	
D 50075 402N	500	370.00	500.00	352	60.00	90.00	3CT 75 402 N	US 0625	HXK 5	CN.. 1204..	US 0613-H25	HXK 2.5	HXK 5	HXK 4	16.74	

**D90**

PRAMET

S(P)

**Hrubovací vyvrtávací hlava 90° pro Ø24 - Ø82 mm**

Vyvrtávací hlava 90° pro hrubovací operace. Vhodná pro vyvrtávání v průchozích i slepých otvorech. Vhodné pro destičky typu CC..., TC..., CN... a rozsah průměrů Ø24 - Ø82 mm. CZC MS - velikost upínače 22 - 54. Vysoká přesnost a opakovatelnost procesu.

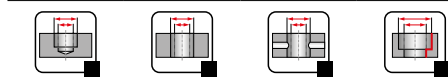
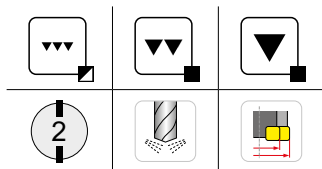
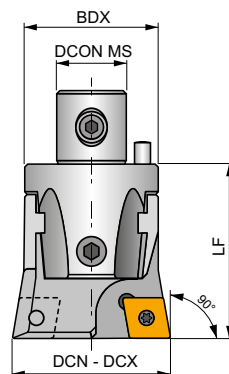

Produkt	CZC MS	DCN	DCX	BDX	DCON MS	LF							
D 02290 400	22	24.00	30.00	22	12.00	34.00	CC.. 0602..	US 0206-T08P	SDT T08P	HXX 2	HXX 3	0.10	
D 02790 401	27	29.00	40.00	27	15.00	42.00	CC.. 0803..	US 0307-T10P	SDR T10P	HXX 2	HXX 4	0.17	
D 02790 409	27	29.00	40.00	27	15.00	42.00	CC.. 09T3..	US 0408-T15P	SDR T15P	HXX 2	HXX 4	0.17	
D 03290 401	32	39.00	50.00	32	20.00	45.00	CC.. 0803..	US 0307-T10P	SDR T10P	HXX 2.5	HXX 4	0.03	
D 03290 409	32	39.00	50.00	32	20.00	45.00	CC.. 09T3..	US 0408-T15P	SDR T15P	HXX 2.5	HXX 4	0.27	
D 04290 300	42	49.00	65.00	42	24.00	56.00	TC.. 16T3..	US 0415-T15P	SDR T15P	HXX 3	HXX 5	0.54	
D 04290 402	42	49.00	65.00	42	24.00	56.00	CC.. 1204..	US 0513-T20P	SDR T20P	HXX 3	HXX 5	0.54	
D 04290 402N	42	53.00	65.00	42	24.00	56.00	CN.. 1204..	US 0613-H25	HXX 2.5	HXX 3	HXX 5	0.53	
D 05490 300	54	63.00	82.00	54	28.00	66.00	TC.. 16T3..	US 0415-T15P	SDR T15P	HXX 3	HXX 6	1.06	
D 05490 402	54	63.00	82.00	54	28.00	66.00	CC.. 1204..	US 0513-T20P	SDR T20P	HXX 3	HXX 6	1.06	
D 05490 402N	54	63.00	82.00	54	28.00	66.00	CN.. 1204..	US 0613-H25	HXX 2.5	HXX 3	HXX 6	1.06	



D90-C

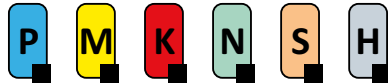

PRAMET

S(P)



Hrubovací vyvrtávací hlava 90° pro Ø80 - Ø220 mm

Vyvrtávací hlava 90° pro hrubovací operace. Vhodná pro vyvrtávání v průchozích i slepých otvorech. Vhodné pro destičky typu CC..., TC..., CN... a rozsah průměrů Ø80 - Ø220 mm. CZC MS - velikost upínače 68 - 200. Vysoká přesnost a opakovatelnost procesu.

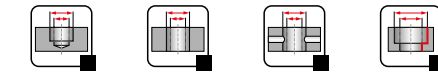
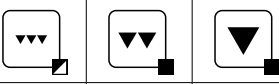
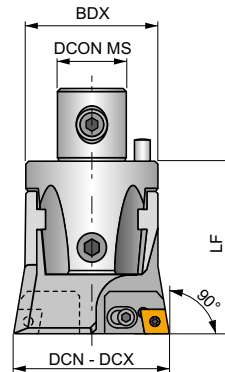

Produkt	CZC MS	DCN	DCX	BDX	DCON MS	LF									
D 06890 300	68	80.00	102.00	68	36.00	86.00	2CT 90 300	US 0616	HXK 5	TC.. 16T3..	US 0408-T15P	SDR T15P	HXK 4	HXK 8	2.17
D 06890 402	68	80.00	102.00	68	36.00	86.00	2CT 90 402	US 0616	HXK 5	CC.. 1204..	US 0509-T20P	SDR T20P	HXK 4	HXK 8	2.15
D 06890 402N	68	80.00	102.00	68	36.00	86.00	2CT 90 402 N	US 0616	HXK 5	CN.. 1204..	US 0613-H25	HXK 2.5	HXK 4	HXK 8	2.18
D 08590 300	85	100.00	125.00	85	50.00	100.00	3CT 90 300	US 0625	HXK 5	TC.. 16T3..	US 0415-T15P	SDR T15P	HXK 5	HXK 8	4.52
D 08590 402	85	100.00	125.00	85	50.00	100.00	3CT 90 402	US 0625	HXK 5	CC.. 1204..	US 0513-T20P	SDR T20P	HXK 5	HXK 8	4.12
D 08590 402 N	85	100.00	125.00	85	50.00	100.00	3CT 90 402 N	US 0625	HXK 5	CN.. 1204..	US 0613-H25	HXK 2.5	HXK 5	HXK 8	4.17
D 10090 300	100	125.00	160.00	110	60.00	100.00	3CT 90 300	US 0625	HXK 5	TC.. 16T3..	US 0415-T15P	SDR T15P	HXK 5	HXK 8	6.54
D 10090 402	100	125.00	160.00	110	60.00	100.00	3CT 90 402	US 0625	HXK 5	CC.. 1204..	US 0513-T20P	SDR T20P	HXK 5	HXK 8	6.56
D 10090 402 N	100	125.00	160.00	110	60.00	100.00	3CT 90 402 N	US 0625	HXK 5	CN.. 1204..	US 0613-H25	HXK 2.5	HXK 5	HXK 8	6.40
D 20090 300	200	160.00	220.00	145	60.00	100.00	3CT 90 300	US 0625	HXK 5	TC.. 16T3..	US 0415-T15P	SDR T15P	HXK 5	HXK 8	8.90
D 20090 402	200	160.00	220.00	145	60.00	100.00	3CT 90 402	US 0625	HXK 5	CC.. 1204..	US 0513-T20P	SDR T20P	HXK 5	HXK 8	8.89
D 20090 402 N	200	160.00	220.00	145	60.00	100.00	3CT 90 402 N	US 0625	HXK 5	CN.. 1204..	US 0613-H25	HXK 2.5	HXK 5	HXK 8	8.91



D90-BB

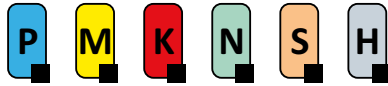

PRAMET

S(P)



Hrubovací vyvrtávací hlava 90° pro Ø220 - Ø500 mm

Vyvrtávací hlava 90° pro hrubovací operace. Vhodná pro vyvrtávání v průchozích i slepých otvorech. Vhodné pro destičky typu CC..., TC..., CN... a rozsah průměrů Ø220 - Ø500mm. CZC MS - velikost upínače 300 - 500. Vysoká přesnost a opakovatelnost procesu.

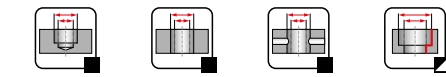
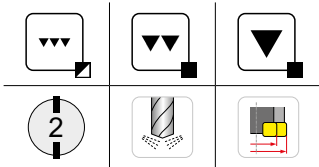
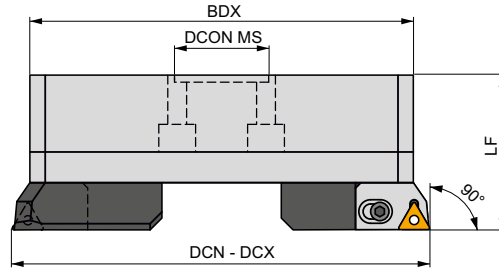

Produkt	CZC MS	DCN	DCX	BDX	DCON MS	LF										
		(mm)	(mm)	(mm)	(mm)	(mm)										
D 30090 300	300	220.00	320.00	202	60.00	90.00	3CT 90 300	US 0625	HXK 5	TC.. 16T3..	US 0415-T15P	SDRT15P	HXK 5	HXK 4	9.45	
D 30090 402	300	220.00	320.00	202	60.00	90.00	3CT 90 402	US 0625	HXK 5	CC.. 1204..	US 0513-T20P	SDRT20P	HXK 5	HXK 4	9.47	
D 30090 402 N	300	220.00	320.00	202	60.00	90.00	3CT 90 402 N	US 0625	HXK 5	CN.. 1204..	US 0613-H25	HXK 2.5	HXK 5	HXK 4	9.56	
D 40090 300	400	290.00	400.00	272	60.00	90.00	3CT 90 300	US 0625	HXK 5	TC.. 16T3..	US 0415-T15P	SDRT15P	HXK 5	HXK 4	12.98	
D 40090 402	400	290.00	400.00	272	60.00	90.00	3CT 90 402	US 0625	HXK 5	CC.. 1204..	US 0513-T20P	SDRT20P	HXK 5	HXK 4	12.98	
D 40090 402 N	400	290.00	400.00	272	60.00	90.00	3CT 90 402 N	US 0625	HXK 5	CN.. 1204..	US 0613-H25	HXK 2.5	HXK 5	HXK 4	12.98	
D 50090 300	500	370.00	500.00	352	60.00	90.00	3CT 90 300	US 0625	HXK 5	TC.. 16T3..	US 0415-T15P	SDRT15P	HXK 5	HXK 4	16.58	
D 50090 402	500	370.00	500.00	352	60.00	90.00	3CT 90 402	US 0625	HXK 5	CC.. 1204..	US 0513-T20P	SDRT20P	HXK 5	HXK 4	16.74	
D 50090 402 N	500	370.00	500.00	352	60.00	90.00	3CT 90 402 N	US 0625	HXK 5	CN.. 1204..	US 0613-H25	HXK 2.5	HXK 5	HXK 4	16.63	

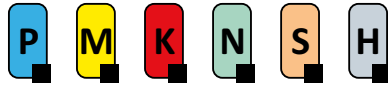
**F75****PRAMET****S****Dokončovací vyvrtávací hlava 75° pro Ø24 - Ø82 mm**

Vyvrtávací hlava 75° pro dokončovací operace. Vhodná pro vyvrtávání v průchozích i slepých otvorech a srážení hran spirálovou interpolací. Vhodné pro destičky typu CC..., TC... a rozsah průměrů Ø24 - Ø82 mm. CZC MS - velikost upínače 22 - 54. Vysoká přesnost a opakovatelnost procesu.

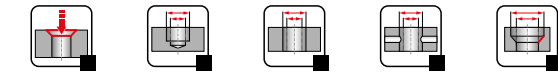
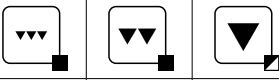
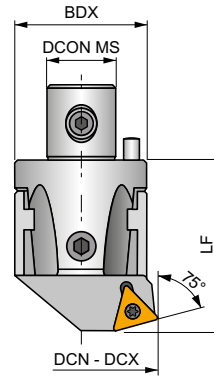

Produkt	CZC MS	DCN	DCX	BDX	DCON MS	LF						
		(mm)	(mm)	(mm)	(mm)	(mm)						
A 02275 400	22	24.00	30.00	22	12.00	34.00	CC.. 0602..	US 0206-T08P	SDR T08P	HXK 2	HXK 3	0.10
A 02775 401	27	29.00	40.00	27	15.00	42.00	CC.. 0803..	US 0307-T10P	SDR T10P	HXK 2	HXK 4	0.17
A 02775 409	27	29.00	40.00	27	15.00	42.00	CC.. 09T3..	US 0408-T15P	SDR T15P	HXK 2	HXK 4	0.17
A 03275 401	32	39.00	50.00	32	20.00	45.00	CC.. 0803..	US 0307-T10P	SDR T10P	HXK 2.5	HXK 4	0.26
A 03275 409	32	39.00	50.00	32	20.00	45.00	CC.. 09T3..	US 0408-T15P	SDR T15P	HXK 2.5	HXK 4	0.26
A 04275 300	42	49.00	65.00	42	24.00	56.00	TC.. 16T3..	US 0307-T10P	SDR T10P	HXK 3	HXK 5	0.51
A 05475 300	54	63.00	82.00	54	28.00	66.00	TC.. 16T3..	US 0415-T15P	SDR T15P	HXK 3	HXK 6	1.01



F75-C

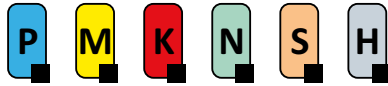

PRAMET

S(P)



Dokončovací vyvrtávací hlava 75° pro Ø80 - Ø220 mm

Vyvrtávací hlava 75° pro dokončovací operace. Vhodná pro vyvrtávání v průchozích i slepých otvorech a srážení hran spirálovou interpolací. Vhodné pro destičky typu CC..., TC..., CN... a rozsah průměrů Ø80 - Ø220 mm. CZC MS - velikost upínače 68 - 200. Vysoká přesnost a opakovatelnost procesu.

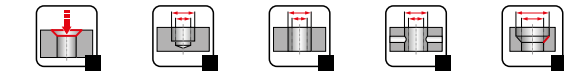
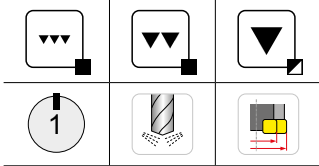
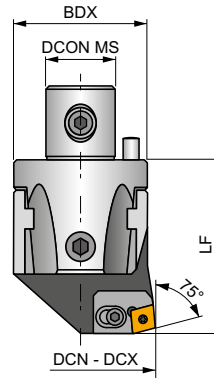

Produkt	CZC MS	DCN	DCX	BDX	DCON MS	LF									
A 06875 300	68	80.00	102.00	68	36.00	86.00	2CT 75 300	US 0616	HXK 5	TC.. 16T3..	US 0408-T15P	SDRT15P	HXK 5	HXK 8	2.02
A 06875 402	68	80.00	102.00	68	36.00	86.00	2CT 75 402	US 0616	HXK 5	CC.. 1204..	US 0509-T20P	SDRT20P	HXK 5	HXK 8	2.03
A 06875 402 N	68	80.00	102.00	68	36.00	86.00	2CT 75 402 N	US 0616	HXK 5	CN.. 1204..	US 0613-H25	HXK 2.5	HXK 5	HXK 8	2.04
A 08575 300	85	100.00	125.00	85	50.00	100.00	3CT 75 300	US 0625	HXK 5	TC.. 16T3..	US 0415-T15P	SDRT15P	HXK 6	HXK 8	3.89
A 08575 402	85	100.00	125.00	85	50.00	100.00	3CT 75 402	US 0625	HXK 5	CC.. 1204..	US 0513-T20P	SDRT20P	HXK 6	HXK 8	3.88
A 08575 402 N	85	100.00	125.00	85	50.00	100.00	3CT 75 402 N	US 0625	HXK 5	CN.. 1204..	US 0613-H25	HXK 2.5	HXK 6	HXK 8	3.90
A 10075 300	100	125.00	160.00	110	60.00	100.00	3CT 75 300	US 0625	HXK 5	TC.. 16T3..	US 0415-T15P	SDRT15P	HXK 6	HXK 8	6.22
A 10075 402	100	125.00	160.00	110	60.00	100.00	3CT 75 402	US 0625	HXK 5	CC.. 1204..	US 0513-T20P	SDRT20P	HXK 6	HXK 8	6.24
A 10075 402 N	100	125.00	160.00	110	60.00	100.00	3CT 75 402 N	US 0625	HXK 5	CN.. 1204..	US 0613-H25	HXK 2.5	HXK 6	HXK 8	6.25
A 20075 300	200	160.00	220.00	145	60.00	100.00	3CT 75 300	US 0625	HXK 5	TC.. 16T3..	US 0415-T15P	SDRT15P	HXK 6	HXK 8	8.30
A 20075 402	200	160.00	220.00	145	60.00	100.00	3CT 75 402	US 0625	HXK 5	CC.. 1204..	US 0513-T20P	SDRT20P	HXK 6	HXK 8	8.33
A 20075 402 N	200	160.00	220.00	145	60.00	100.00	3CT 75 402 N	US 0625	HXK 5	CN.. 1204..	US 0613-H25	HXK 2.5	HXK 6	HXK 8	8.33



F75-BB

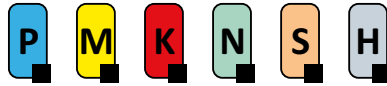

PRAMET

S(P)



Dokončovací vyvrtávací hlava 75° pro Ø220 - Ø500 mm

Vyvrtávací hlava 75° pro dokončovací operace. Vhodná pro vyvrtávání v průchozích i slepých otvorech a srážení hran spirálovou interpolací. Vhodné pro destičky typu CC..., TC..., CN... a rozsah průměrů Ø220 - Ø500 mm. CZC MS - velikost upínače 300 - 500. Vysoká přesnost a opakovatelnost procesu.

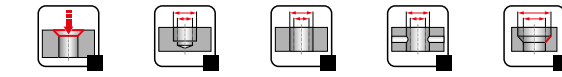
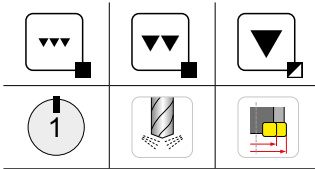
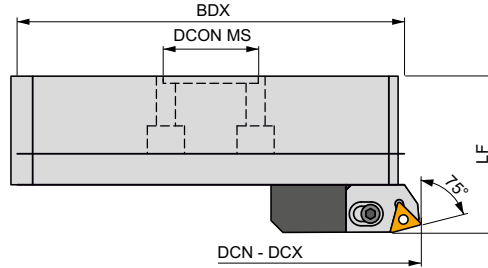

Produkt	CZC MS	DCN	DCX	BDX	DCON MS	LF									
		(mm)	(mm)	(mm)	(mm)	(mm)									
A 30075 300	300	220.00	320.00	202	60.00	90.00	3CT 75 300	US 0625	HXK 5	TC.. 16T3..	US 0415-T15P	SDR T15P	HXK 5	HXK 4	8.75
A 30075 402	300	220.00	320.00	202	60.00	90.00	3CT 75 402	US 0625	HXK 5	CC.. 1204..	US 0513-T20P	SDR T20P	HXK 5	HXK 4	8.75
A 30075 402 N	300	220.00	320.00	202	60.00	90.00	3CT 75 402 N	US 0625	HXK 5	CN.. 1204..	US 0613-H25	HXK 2.5	HXK 5	HXK 4	8.30
A 40075 300	400	290.00	400.00	272	60.00	90.00	3CT 75 300	US 0625	HXK 5	TC.. 16T3..	US 0415-T15P	SDR T15P	HXK 5	HXK 4	12.20
A 40075 402	400	290.00	400.00	272	60.00	90.00	3CT 75 402	US 0625	HXK 5	CC.. 1204..	US 0513-T20P	SDR T20P	HXK 5	HXK 4	12.20
A 40075 402 N	400	290.00	400.00	272	60.00	90.00	3CT 75 402 N	US 0625	HXK 5	CN.. 1204..	US 0613-H25	HXK 2.5	HXK 5	HXK 4	12.15
A 50075 300	500	370.00	500.00	352	60.00	90.00	3CT 75 300	US 0625	HXK 5	TC.. 16T3..	US 0415-T15P	SDR T15P	HXK 5	HXK 4	16.31
A 50075 402	500	370.00	500.00	352	60.00	90.00	3CT 75 402	US 0625	HXK 5	CC.. 1204..	US 0513-T20P	SDR T20P	HXK 5	HXK 4	16.31
A 50075 402 N	500	370.00	500.00	352	60.00	90.00	3CT 75 402 N	US 0625	HXK 5	CN.. 1204..	US 0613-H25	HXK 2.5	HXK 5	HXK 4	16.00

**F90**

PRAMET

S(P)

**Dokončovací vyvrtávací hlava 90° pro Ø24 - Ø82 mm**

Vyvrtávací hlava 90° pro dokončovací operace. Vhodná pro vyvrtávání v průchozích i slepých otvorech. Vhodné pro destičky typu CC..., TC..., CN... a rozsah průměrů Ø24 - Ø82 mm. CZC MS - velikost upínače 22 - 54. Vysoká přesnost a opakovatelnost procesu.

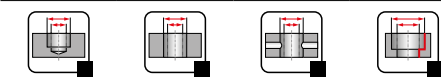
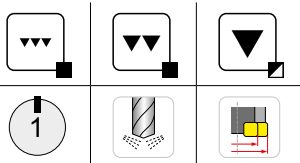
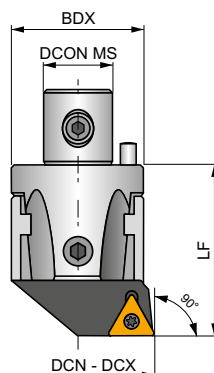

Produkt	CZC MS	DCN	DCX	BDX	DCON MS	LF						
A 02290 400	22	24.00	30.00	22	12.00	34.00	CC.. 0602..	US 0206-T08P	SDR T08P	HXK 2	HXK 3	0.10
A 02790 401	27	29.00	40.00	27	15.00	42.00	CC.. 0803..	US 0307-T10P	SDR T10P	HXK 2	HXK 4	0.17
A 02790 409	27	29.00	40.00	27	15.00	42.00	CC.. 09T3..	US 0408-T15P	SDR T15P	HXK 2	HXK 4	0.16
A 03290 300	32	39.00	50.00	32	20.00	45.00	TC.. 16T3..	US 0408-T15P	SDR T15P	HXK 2.5	HXK 4	0.26
A 03290 401	32	39.00	50.00	32	20.00	45.00	CC.. 0803..	US 0206-T08P	SDR T08P	HXK 2.5	HXK 4	0.26
A 03290 409	32	39.00	50.00	32	20.00	45.00	CC.. 09T3..	US 0408-T15P	SDR T15P	HXK 2.5	HXK 4	0.26
A 04290 300	42	49.00	65.00	42	24.00	56.00	TC.. 16T3..	US 0415-T15P	SDR T15P	HXK 3	HXK 5	0.51
A 04290 402	42	49.00	65.00	42	24.00	56.00	CC.. 1204..	US 0513-T20P	SDR T20P	HXK 3	HXK 5	0.51
A 04290 402 N	42	49.00	65.00	42	24.00	56.00	CN.. 1204..	US 0613-H25	HXK 2.5	HXK 3	HXK 5	0.50
A 05490 300	54	63.00	82.00	54	28.00	66.00	TC.. 16T3..	US 0415-T15P	SDR T15P	HXK 3	HXK 6	1.01
A 05490 402	54	63.00	82.00	54	28.00	66.00	CC.. 1204..	US 0513-T20P	SDR T20P	HXK 3	HXK 6	1.03
A 05490 402 N	54	63.00	82.00	54	28.00	66.00	CN.. 1204..	US 0613-H25	HXK 2.5	HXK 3	HXK 6	1.01



F90-C



PRAMET

S(P)



Dokončovací vyvrtávací hlava 90° pro Ø80 - Ø220 mm

Vyvrtávací hlava 90° pro dokončovací operace. Vhodná pro vyvrtávání v průchozích i slepých otvorech. Vhodné pro destičky typu CC..., TC..., CN... a rozsah průměrů Ø80 - Ø220. CZC MS - velikost upínací 68 - 145. Vysoká přesnost a opakovatelnost procesu.

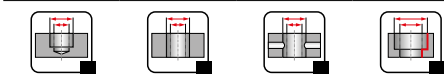
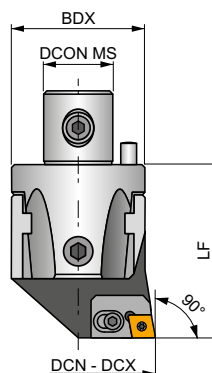

Produkt	CZC MS	DCN	DCX	BDX	DCON MS	LF									
															(mm)
A 06890 300	68	80.00	102.00	68	36.00	86.00	2CT 90 300	US 0616	HXX 5	TC.. 16T3..	US 0408-T15P	SDR T15P	HXX 5	HXX 8	2.03
A 06890 402	68	80.00	102.00	68	36.00	86.00	2CT 90 402	US 0616	HXX 5	CC.. 1204..	US 0509-T15P	SDR T15P	HXX 5	HXX 8	2.03
A 06890 402 N	68	80.00	102.00	68	36.00	86.00	2CT 90 402 N	US 0616	HXX 5	CN.. 1204..	US 0613-H25	HXX 2.5	HXX 5	HXX 8	2.60
A 08590 300	85	100.00	125.00	85	50.00	100.00	3CT 90 300	US 0625	HXX 5	TC.. 16T3..	US 0415-T15P	SDR T15P	HXX 6	HXX 8	3.90
A 08590 402	85	100.00	125.00	85	50.00	100.00	3CT 90 402	US 0625	HXX 5	CC.. 1204..	US 0513-T20P	SDR T20P	HXX 6	HXX 8	3.88
A 08590 402 N	85	100.00	125.00	85	50.00	100.00	3CT 90 402 N	US 0625	HXX 5	CN.. 1204..	US 0613-H25	HXX 2.5	HXX 6	HXX 8	4.04
A 10090 300	100	125.00	160.00	100	60.00	100.00	3CT 90 300	US 0625	HXX 5	TC.. 16T3..	US 0415-T15P	SDR T15P	HXX 6	HXX 8	6.24
A 10090 402	100	125.00	160.00	100	60.00	100.00	3CT 90 402	US 0625	HXX 5	CC.. 1204..	US 0513-T20P	SDR T20P	HXX 6	HXX 8	6.24
A 10090 402 N	100	125.00	160.00	100	60.00	100.00	3CT 90 402 N	US 0625	HXX 5	CN.. 1204..	US 0613-H25	HXX 2.5	HXX 6	HXX 8	6.26
A 20090 300	200	160.00	220.00	145	60.00	100.00	3CT 90 300	US 0625	HXX 5	TC.. 16T3..	US 0415-T15P	SDR T15P	HXX 6	HXX 8	8.30
A 20090 402	200	160.00	220.00	145	60.00	100.00	3CT 90 402	US 0625	HXX 5	CC.. 1204..	US 0513-T20P	SDR T20P	HXX 6	HXX 8	8.29
A 20090 402 N	200	160.00	220.00	145	60.00	100.00	3CT 90 402 N	US 0625	HXX 5	CN.. 1204..	US 0613-H25	HXX 2.5	HXX 6	HXX 8	8.33



F90-BB



PRAMET

S(P)



Dokončovací vyvrtávací hlava 90° pro Ø220 - Ø500 mm

Vyvrtávací hlava 90° pro dokončovací operace. Vhodná pro vyvrtávání v průchozích i slepých otvorech. Vhodné pro destičky typu CC..., TC..., CN... a rozsah průměrů Ø220 - Ø500 mm. CZC MS - velikost upínače 202 - 352. Vysoká přesnost a opakovatelnost procesu.

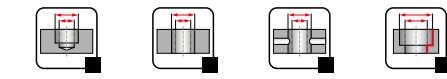
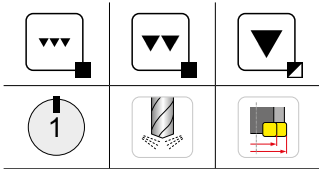
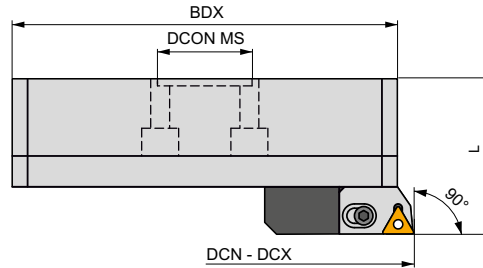

Produkt	CZC MS	DCN	DCX	BDX	DCON MS	LF									
	(mm)	(mm)	(mm)	(mm)	(mm)	(mm)									
A 30090 300	300	220.00	320.00	202	60.00	90.00	3CT 90 300	US 0625	HXK 5	TC.. 16T3..	US 0415-T15P	SDR T15P	HXK 5	HXK 4	8.74
A 30090 402	300	220.00	320.00	202	60.00	90.00	3CT 90 402	US 0625	HXK 5	CC.. 1204..	US 0513-T20P	SDR T20P	HXK 5	HXK 4	8.82
A 30090 402 N	300	220.00	320.00	202	60.00	90.00	3CT 90 402 N	US 0625	HXK 5	CN.. 1204..	US 0613-H25	HXK 2.5	HXK 5	HXK 4	8.75
A 40090 300	400	290.00	400.00	272	60.00	90.00	3CT 90 300	US 0625	HXK 5	TC.. 16T3..	US 0415-T15P	SDR T15P	HXK 5	HXK 4	12.19
A 40090 402	400	290.00	400.00	272	60.00	90.00	3CT 90 402	US 0625	HXK 5	CC.. 1204..	US 0513-T20P	SDR T20P	HXK 5	HXK 4	12.50
A 40090 402 N	400	290.00	400.00	272	60.00	90.00	3CT 90 402 N	US 0625	HXK 5	CN.. 1204..	US 0613-H25	HXK 2.5	HXK 5	HXK 4	12.20
A 50090 300	500	370.00	500.00	352	60.00	90.00	3CT 90 300	US 0625	HXK 5	TC.. 16T3..	US 0415-T15P	SDR T15P	HXK 5	HXK 4	16.08
A 50090 402	500	370.00	500.00	352	60.00	90.00	3CT 90 402	US 0625	HXK 5	CC.. 1204..	US 0513-T20P	SDR T20P	HXK 5	HXK 4	16.20
A 50090 402 N	500	370.00	500.00	352	60.00	90.00	3CT 90 402 N	US 0625	HXK 5	CN.. 1204..	US 0613-H25	HXK 2.5	HXK 5	HXK 4	16.00

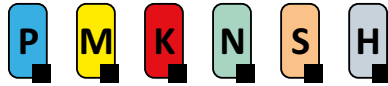
**MB-H****PRAMET****S****Vyvrťovací hlava pro velmi malé otvory Ø8 - Ø38 mm**

Produktivní mikro vyvrťovací hlava umožňuje vysokou přesnost a opakovatelnost procesu. Vhodná pro průchozí i slepé otvory i osazení. Do hlavy lze upnout vyvrťovací tyče se stopkou Ø6.0 - Ø16.0 mm. CZC MS - velikost upínače 27 - 42.

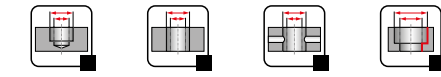
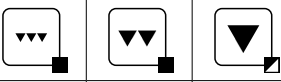
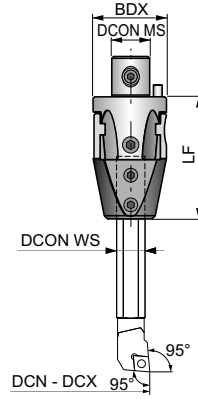

Produkt	CZC MS	DCN	DCX	BDX	DCON MS	DCON WS	LB			
		(mm)	(mm)	(mm)	(mm)	(mm)				
A 027 006	27	8.00	20.00	27	15.00	6.00	50.00	HXK 2	HXK 4	0.20
A 027 008	27	10.00	21.00	27	15.00	8.00	50.00	HXK 2	HXK 4	0.19
A 032 008	32	10.00	21.00	32	20.00	8.00	58.00	HXK 2.5	HXK 4	0.32
A 032 010	32	13.00	25.00	32	20.00	10.00	58.00	HXK 2.5	HXK 4	0.32
A 042 010	42	13.00	29.00	42	24.00	10.00	70.00	HXK 3	HXK 5	0.64
A 042 012	42	16.00	34.00	42	24.00	12.00	70.00	HXK 3	HXK 5	0.64
A 042 016	42	20.00	38.00	42	24.00	16.00	70.00	HXK 3	HXK 5	0.62



ISO BARS



Vyvrťovací tyče pro Mikro vyvrťovací hlavu, Stopka Ø6 - Ø16 mm

Vhodné pro slepé i průchozí otvory a osazení. Lze osadit destičkami typu EP..., TC..., CC...

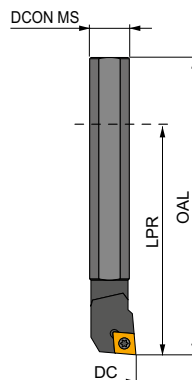

Produkt	DCON MS (mm)	DC (mm)	OAL (mm)	LPR (mm)				Carbide	kg
S06E SELPR 05-B	6.00	8.00	70.0	46	EP.. 0502..	US 0205-T07P	SDR T07P	–	0.04
S08F SCLCR 06-B	8.00	10.00	80.0	50	CC.. 0602..	US 0205-T08P	SDR T08P	–	0.04
S10G SCLCR 06-B	10.00	13.00	90.0	54	CC.. 0602..	US 0206-T08P	SDR T08P	–	0.06
S12H SCLCR 06-B	12.00	16.00	100.0	64	CC.. 0602..	US 0206-T08P	SDR T08P	–	0.11
S16J SCLCR 09-B	16.00	20.00	110.0	74	CC.. 09T3..	US 0408-T15P	SDR T15P	–	0.18
S16J STFCR 09-B	16.00	20.00	110.0	74	TC.. 0902..	US 0206-T07P	SDR T07P	–	0.18
S16J STFCR 16-B	16.00	20.00	110.0	74	TC.. 16T3..	US 0408-T15P	SDR T15P	–	0.18
C08G SCLCR 06	8.00	10.00	90.0	60	CC.. 0602..	US 0205-T08P	SDR T08P	✓	1.00
C10J SCLCR 06	10.00	13.00	110.0	74	CC.. 0602..	US 0206-T08P	SDR T08P	✓	0.13
C12K SCLCR 06	12.00	16.00	125.0	89	CC.. 0602..	US 0206-T08P	SDR T08P	✓	0.20
C16L SCLCR 09	16.00	20.00	140.0	104	CC.. 09T3..	US 0408-T15P	SDR T15P	✓	0.38



ISO BARS A042

**Vyrtávací tyče pro A042 mikro vyrtávací hlavu**

Vyrtávací tyče se zesílenou stopkou $\varnothing 16$ mm. Vhodné pro slepé i průchozí otvory a osazení. Lze osadit destičkami typu EP., TC., CC..

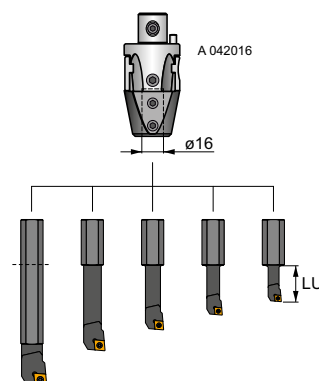

Produkt	DCN	DCX	LU				
	(mm)	(mm)	(mm)				
S06/16 SELPR 05	8.00	26.00	25.00	EP.. 0502..	US 0205-T07P	SDR T07P	0.08
S06/16 STFCR 06	8.00	26.00	25.00	TC.. 06T1..	US 0405-T06P	SDR T06P	0.08
S08/16 SCLCR 06	10.00	28.00	35.00	CC.. 0602..	US 0205-T08P	SDR T08P	0.09
S08/16 STFCR 06	10.00	28.00	35.00	TC.. 06T1..	US 0405-T06P	SDR T06P	0.07
S10/16 SCLCR 06	13.00	31.00	45.00	CC.. 0602..	US 0206-T08P	SDR T08P	0.10
S10/16 STFCR 09	13.00	31.00	45.00	TC.. 0902..	US 0206-T07P	SDR T07P	0.10
S12/16 SCLCR 06	16.00	34.00	57.00	CC.. 0602..	US 0206-T08P	SDR T08P	0.13
S12/16 STFCR 09	16.00	34.00	57.00	TC.. 0902..	US 0206-T07P	SDR T07P	0.13
S16/16 SCLCR 09	20.00	38.00	73.00	CC.. 09T3..	US 0408-T15P	SDR T15P	0.18
S16/16 STFCR 09	20.00	38.00	73.00	TC.. 0902..	US 0206-T07P	SDR T07P	0.18
S16/16 STFCR 16	20.00	38.00	73.00	TC.. 0902..	US 0408-T15P	SDR T15P	0.18



PŘÍSLUŠENSTVÍ

1	2	3	4
2CT	90	402 N	S

1	2	3	4
Typ nástroje	Úhel břitu	Typ VBD	Varianta
2CT	30	300 TC..16T3.	S Stupňovité vyvrtávání
3CT	45	402 CC..1204..	
	75	402N CN..1204..	
	90		



Symetrické vyvrtávání

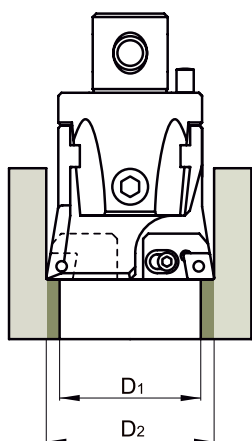

2CT □□ □□□ + 2CT □□ □□□
 3CT □□ □□□ + 3CT □□ □□□

Stupňovité vyvrtávání

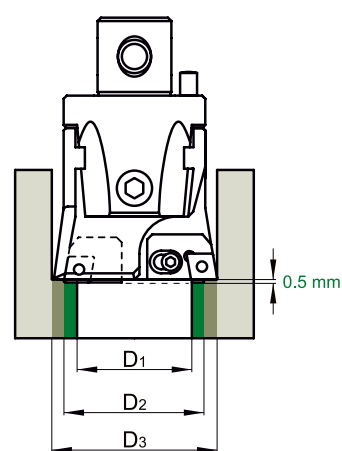

2CT □□ □□□ S + 2CT □□ □□□
 3CT □□ □□□ S + 3CT □□ □□□



CART-BS-SPC



PRAMET

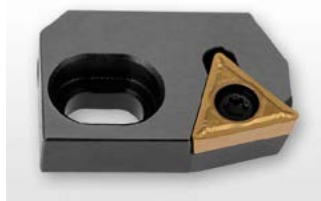

Speciální kazety 2CT a 3CT pro vyvrtávací hlavy

Speciální kazety pro vyvrtávací hlavy, velikost 2CT a 3CT dostupné s úhly nastavení 30° nebo 45°. Pro hrubovací a dokončovací operace. Vhodné pro destičky typu TC., CC., CN. . . .

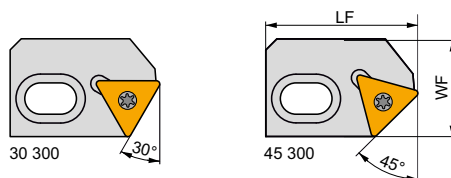

Produkt	WF	LF									
	(mm)	(mm)									
2CT 30 300	22.5	35.00	US 0616	HXK 5	US 0430	HXK 2	TC.. 16T3..	US 0408-T15P	SDR T15P		0.59
2CT 45 300	22.5	35.00	US 0616	HXK 5	US 0430	HXK 2	TC.. 16T3..	US 0408-T15P	SDR T15P		0.05
2CT 90 300 S	23	33.00	US 0616	HXK 5	US 0430	HXK 2	TC.. 16T3..	US 0408-T15P	SDR T15P		0.05
2CT 90 402 N S	23	33.00	US 0616	HXK 5	US 0430	HXK 2	CN.. 1204.. L	US 0613-H25	HXK 2.5		0.07
2CT 90 402 S	23	33.00	US 0616	HXK 5	US 0430	HXK 2	CC.. 1204..	US 0509-T20P	SDR T20P		0.05
3CT 30 300	28	39.00	US 0625	HXK 5	US 0635	HXK 3	TC.. 16T3..	US 0415-T15P	SDR T15P		0.10
3CT 45 300	28	39.00	US 0625	HXK 5	US 0635	HXK 3	TC.. 16T3..	US 0415-T15P	SDR T15P		0.10
3CT 90 300 S	28.5	37.00	US 0625	HXK 5	US 0635	HXK 3	TC.. 16T3..	US 0415-T15P	SDR T15P		0.10
3CT 90 402 N S	28.5	37.00	US 0625	HXK 5	US 0635	HXK 3	CN.. 1204.. L	US 0613-H25	HXK 2.5		0.11
3CT 90 402 S	28.5	37.00	US 0625	HXK 5	US 0635	HXK 3	CC.. 1204..	US 0513-T20P	SDR T20P		0.09



CART-BS-STD



PRAMET



Standartní kazety 2CT a 3CT pro vyvrtávací hlavy

Standartní kazety pro vyvrtávací hlavy, velikost 2CT a 3CT dostupné s úhly nastavení 75° nebo 90°. Pro hrubovací a dokončovací operace. Vhodné pro destičky typu TC., CC., CN...

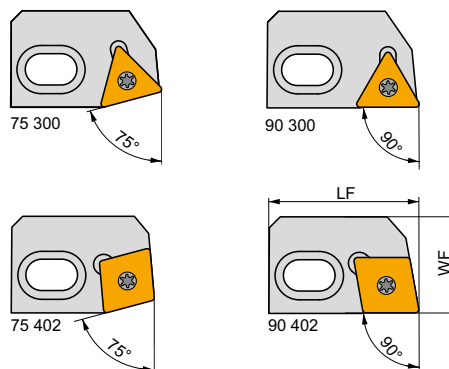

Produkt	WF	LF								kg
	(mm)	(mm)								
2CT 75 300	22.5	35.00	US 0616	HXK 5	US 0430	HXK 2	TC.. 16T3..	US 0408-T15P	SDR T15P	0.06
2CT 75 402	22.5	35.00	US 0616	HXK 5	US 0430	HXK 2	CC.. 1204..	US 0509-T20P	SDR T20P	0.06
2CT 75 402 N	22.5	35.00	US 0616	HXK 5	US 0430	HXK 2	CN.. 1204.. R	US 0613-H25	HXK 2.5	0.07
2CT 90 300	22.5	35.00	US 0616	HXK 5	US 0430	HXK 2	TC.. 16T3..	US 0408-T15P	SDR T15P	0.05
2CT 90 402	22.5	35.00	US 0616	HXK 5	US 0430	HXK 2	CC.. 1204..	US 0509-T20P	SDR T20P	0.05
2CT 90 402 N	22.5	35.00	US 0616	HXK 5	US 0430	HXK 2	CN.. 1204.. L	US 0613-H25	HXK 2.5	0.07
3CT 75 300	28	39.00	US 0625	HXK 5	US 0635	HXK 3	TC.. 16T3..	US 0415-T15P	SDR T15P	0.10
3CT 75 402	28	39.00	US 0625	HXK 5	US 0635	HXK 3	CC.. 1204..	US 0509-T20P	SDR T20P	0.10
3CT 75 402 N	28	39.00	US 0625	HXK 5	US 0635	HXK 3	CN.. 1204.. R	US 0613-H25	HXK 2.5	0.12
3CT 90 300	28	39.00	US 0625	HXK 5	US 0635	HXK 3	TC.. 16T3..	US 0415-T15P	SDR T15P	0.11
3CT 90 402	28	39.00	US 0625	HXK 5	US 0635	HXK 3	CC.. 1204..	US 0509-T20P	SDR T20P	0.10
3CT 90 402 N	28	39.00	US 0625	HXK 5	US 0635	HXK 3	CN.. 1204.. L	US 0613-H25	HXK 2.5	0.12



CHAM-BS



PRAMET

S



CH-BS Kroužek na srážení hran pro vyvrtávací hlavy

45° kroužek na srážení hran pro systém vyvrtávání. Průměry od 22 do 42 mm - destičky DC.. 11T3.. a průměry od 54 do 200 mm - destičky DC.. 1504..

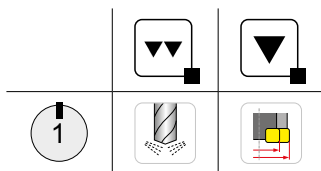
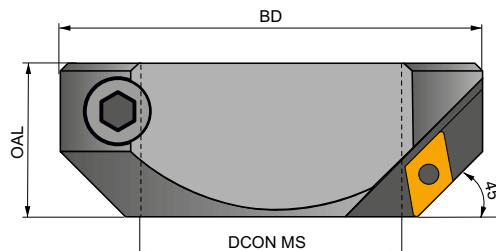

















Produkt	CZC MS	DCON MS	BD	OAL					
		(mm)	(mm)	(mm)					
CH 022	22	22.00	43.00	24.0	DC.. 11T3..	US 0408-T15P	SDRT15P	HXK 4	0.11
CH 027	27	27.00	48.00	24.0	DC.. 11T3..	US 0408-T15P	SDRT15P	HXK 4	0.13
CH 032	32	32.00	62.00	30.0	DC.. 11T3..	US 0408-T15P	SDRT15P	HXK 5	0.29
CH 042	42	42.00	72.00	30.0	DC.. 11T3..	US 0408-T15P	SDRT15P	HXK 5	0.38
CH 054	54	54.00	94.00	40.0	DC.. 1504..	US 0513-T20P	SDRT20P	HXK 6	0.89
CH 068	68	68.00	110.00	40.0	DC.. 1504..	US 0513-T20P	SDRT20P	HXK 8	1.23
CH 085	85	85.00	145.00	55.0	DC.. 1504..	US 0513-T20P	SDRT20P	HXK 10	2.70
CH 100	100	100.00	170.00	60.0	DC.. 1504..	US 0513-T20P	SDRT20P	HXK 14	4.14
CH 200	200	100.00	200.00	60.0	DC.. 1504..	US 0513-T20P	SDRT20P	HXK 14	5.80



VYVRTÁVACÍ DESTIČKY







VYVRTÁVACÍ DESTIČKY – NAVIGÁTOR

CCGT  388	CCGW CBN  390	CCMT  390	CCMW  393
CNGA CBN  394	CNGG  395	CNMA  395	CNMG  396
DCMT  398	DCMW  399	DCMW PCD  399	
EPGX  400	EPMT  400		
TCGT  401	TCMT  402	TCMW  403	

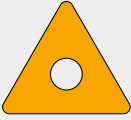

VYMĚNITELNÉ BŘITOVÉ DESTIČKY

Tvar	Značení lůžka	ISO kód
	300	TC..16T3..
	400 401 402 409	CC..0602.. CC..0803.. CC..1204.. CC..09T3..
	402N	CN..1204..
		EP..0502..
		DC..11T3.. DC..1504..

Více detailů o destičkách naleznete ve výrobné části katalogu Soustružení. Detaily o geometriích naleznete rovněž v katalogu Soustružení.



ŘEZNÉ MATERIÁLY - NAVIGÁTOR

Označení materiálu	Aplikační oblast	Použití	Posuv	Řezná rychlost	Odolnost vůči nepříznivým pracovním podmínkám	Povlak	Barva	Substrát	Výhoda chlazení	Popis materiálu
T9315	P05 - P25	■				MT-CVD		FGM	++	Univerzální materiál s vynikající odolností proti opotřebením i za intenzivních řezných podmínek. Lze jej použít také pro operace s přerušovaným řezem. Díky svým dobře vyváženým vlastnostem může být tento materiál první volbou pro širokou škálu soustružnických operací. Nevhodný pro nízké řezné rychlosti.
	K05 - K25	■								
	H10 - H20	■								
T9325	P15 - P35	■				MT-CVD		FGM	++	Z technologického hlediska se jedná o extrémně univerzální materiál s vysokou odolností proti mechanickému poškození za nepříznivých řezných podmínek, který si zachovává vynikající odolnost proti opotřebením. Správné použití tohoto materiálu vyžaduje vysoké řezné rychlosti.
	M10 - M30	■								
	K15 - K35	■								
	S10 - S20	■								
T9335	P20 - P45	■				MT-CVD		FGM	+++	Jeden z nehouževnatějších materiálů vhodný zejména pro nepříznivé řezné podmínky při středních až vyšších posuvech a středních řezných rychlostech. Oproti svým předchůdcům M15–M40 má nejen vyšší houževnatost, ale i otěruvzdornost, která vynikne při aplikaci intenzivních řezných podmínek.
	M15 - M40	■								
	S15 - S25	■								
T7325	P15 - P35	■				MT-CVD		FGM	+++	Jeden z nejuniverzálnějších materiálů pro soustružení. Určen zejména pro obrábění korozivzdorné oceli. Optimální vyváženost mezi odolností vůči opotřebením a provozní spolehlivostí. Vhodný pro širokou škálu aplikací v soustružnických operacích.
	M10 - M25	■								
	S10 - S25	■								
T7335	P20 - P40	■				MT-CVD		FGM	+++	Materiál s funkčně odstupňovaným substrátem vyznačující se velmi vysokou provozní spolehlivostí a velmi dobrou odolností vůči opotřebením. Nejlepší uplatnění nalezne při obrábění velmi houževnatých materiálů M20–M40.
	M20 - M40	■								
	S15 - S25	■								
T5305	P05 - P15	■				MT-CVD		H	+	Materiál s velmi vysokou odolností proti chemickým typům opotřebením; vhodný pro dokončovací operace s vysokou řeznou rychlostí. Díky své vysoké otěruvzdornosti je vhodný i pro produktivní K01–K15, obrábění kalených a zúšlechťených materiálů.
	K01 - K15	■								
	H05 - H15	■								
T5315	P10 - P25	■				MT-CVD		H	+	Materiál prioritně určený pro produktivní obrábění s vysokou odolností vůči otěru a dobrou provozní spolehlivostí. Díky svým vlastnostem je tento materiál vhodný zejména pro dokončovací a polohrubovací operace za dobrých, až mírně zhoršených záběrových podmínek.
	K10 - K25	■								
	H15 - H25	■								
T8315	P05 - P20	■				PVD		submicron H	++	Materiál s vynikající otěruvzdorností při zachování nadprůměrné provozní spolehlivosti, který je vhodný pro obrábění při středních až vysokých řezných rychlostech u tvrdších materiálů s krátkou třískou.
	M05 - M20	■								
	K05 - K25	■								
	N05 - N25	■								
	S05 - S15	■								
	H05 - H15	■								
T8330	P25 - P40	■				PVD		submicron H	+++	Bezesporu nejuniverzálnější řezný materiál využitelný pro obrábění všech typů obráběných materiálů a prakticky aplikovatelný skoro ve všech typech soustružnických operací. Jeho hlavní výhodou je vysoká provozní spolehlivost a velmi dobré funkční vlastnosti; je proto vhodný pro použití při středních a nižších řezných rychlostech.
	M20 - M35	■								
	K20 - K40	■								
	N15 - N30	■								
	S15 - S25	■								
	H15 - H25	■								
T6310	P01 - P15	■				PVD		ultra submicron H	+++	Vysoce otěruvzdorný materiál pro soustružení s vynikajícím PVD povlakem. Vhodný pro dokončovací operace a aplikace, kde je velmi důležitá ostrá řezná hrana spolu s vysokou odolností proti opotřebením hřbetu.
	M01 - M15	■								
	K05 - K20	■								
	N05 - N20	■								
	S01 - S15	■								
	H01 - H15	■								



ŘEZNÉ MATERIÁLY - NAVIGÁTOR

Označení materiálu	Aplikační oblast	Použití	Posuv	Řezná rychlost	Odolnost vůči nepříznivým pracovním podmínkám	Povlak	Barva	Substrát	Výhoda chlazení	Popis materiálu
T0315	N05 - N20	■				PVD			++	Submikronový materiál určený k soustružení slitin neželezných kovů a jejich slitin s vyváženým poměrem otěruvzdornosti a houževnatosti. Je opatřen unikátním povlakem s vynikajícími funkčními vlastnostmi.
HF7	M10 - M20	■				×		submicron H	++	Nepovlakovaný materiál určený především pro obrábění neželezných kovů; lze ho však použít i pro ostatní obráběné materiály (s výjimkou ocelí). Tento materiál najde své uplatnění v oblasti soustružení, frézování, a dokonce i vyvrtávání.
	K10 - K25	■								
	N10 - N25	■								
H07	M05 - M15	■				×		submicron H	++	Nepovlakovaný materiál pro soustružení vhodný pro obráběcí aplikace, kde dominantním kritériem životnosti nástroje není odolnost proti oxidaci. Určen pro obrábění slitin na bázi Ti. Materiál vykazuje vysokou pevnost řezné hrany spolu s dobrou odolností vůči opotřebení.
	K10 - K25	■								
	N10 - N30	■								
	S01 - S20	■								
TT310	P10 - P25	■				PVD		cermet	+ / -	Povlakovaný cermet určený pro jemné a dokončovací soustružení uhlíkových i slitinových ocelí (včetně korozivzdorných). Vynikající funkční vlastnosti jsou ještě umocněny povlakem naneseným metodou PVD.
	M15 - M25	■								
TT010	P01 - P10	■				×		cermet	+ / -	Nepovlakovaný cermet vhodný pro jemné obrábění všech typů ocelí (včetně korozivzdorných) při velmi nízkých posuvech. Jeho hlavní výhodou je minimální zaoblení řezné hrany a její vysoká odolnost vůči fyzikálně-chemickým mechanickým opotřebení.
	M01 - M10	■								
PD1	N05 - N25	■				×		PCD	-	Materiál PKD pro soustružení neželezných materiálů. Ideální volba pro práci s vysokou řeznou rychlostí a malými posuvy za stabilních podmínek.
TB310	K01 - K10	■				×		CBN	--	Materiál CBN pro obrábění kalených materiálů. Vhodný pro obrábění s vysokou řeznou rychlostí a malými posuvy za stabilních podmínek.
	S05 - S10	■								
	H01 - H10	■								

Substrát	
H	Substrát na bázi WC-Co
submicron H	Substrát na bázi WC-Co (< 1 mm)
ultra submicron H	Ultra jemnozrný substrát na bázi WC-Co
FGM	Funkční gradientní substrát
Cermet	Slitiny karbidu bez WC
PCD	Polykrystalický diamant
CBN	Polykrystalický kubický nitrid boru

Povlak	
MT-CVD	Středně teplotní chemická metoda povlakování
PVD	Nízkoteplotní fyzikální metoda povlakování
×	Bez povlaku

Přínos řezné kapaliny	
+++	Velmi vysoký přínos
++	Vysoký přínos
+ / -	Sporný přínos
--	Velmi nepříznivý dopad chlazení

VYMĚNITELNÉ BŘITOVÉ DESTIČKY– ISO SYSTÉM ZNAČENÍ

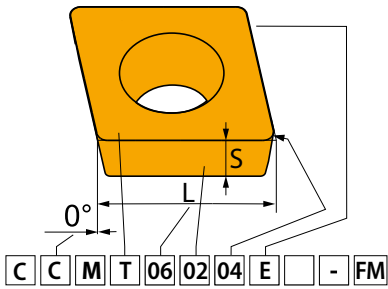

ISO	1	2	3	4
	C	C	M	T
ANSI	1	2	3	4
	C	C	M	T

1				2				4														
Tvar destičky				Úhel hřbetu destičky				Provedení destičky														
H	O	P	R	A	B	C	D	N	R	F	A	M	G	W	T	Q	U	B	H	C	J	X
S	T	C	D	E	F	G	N															
E	M	V	W																			
L	A	B	K	P	O																	

3				3			
Tolerance							
	(mm)			(")			
	M(±)	S(±)	IC(±)	M(±)	S(±)	IC(±)	
A	0.005	0.025	0.025	.0002"	.001"	.0010"	
F	0.005	0.025	0.013	.0002"	.001"	.0005"	
C	0.013	0.025	0.025	.0005"	.001"	.0010"	
H	0.013	0.025	0.013	.0005"	.001"	.0005"	
E	0.025	0.025	0.025	.0010"	.001"	.0010"	
G	0.025	0.130	0.025	.0010"	.005"	.0010"	
J	0.005	0.025	0.05 – 0.13	.0002"	.001"	.002 – 0.005"	
K	0.013	0.025	0.05 – 0.13	.0005"	.001"	.002 – 0.005"	
L	0.025	0.025	0.05 – 0.13	.0010"	.001"	.002 – 0.005"	
M	0.08 – 0.18	0.130	0.05 – 0.13	.003 – 0.007"	.005"	.002 – 0.005"	
N	0.08 – 0.18	0.025	0.05 – 0.13	.003 – 0.007"	.001"	.002 – 0.005"	
U	0.05 – 0.38	0.130	0.05 – 0.13	.005 – 0.015"	.005"	.003 – 0.010"	

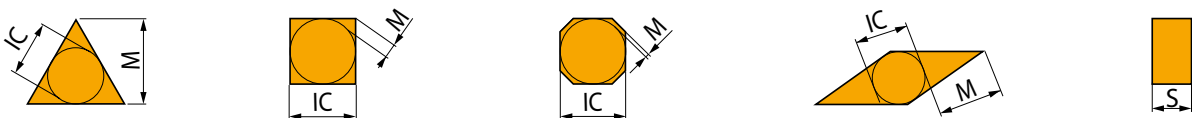



VYMĚNITELNÉ BŘITOVÉ DESTIČKY– ISO SYSTÉM ZNAČENÍ

5	6	7	8	9	10
06	02	04	E	-	FM
5	6	7	8	9	10
2	1.5	1	E	-	FM

5		5												
Délka řezné hrany (velikost) destičky														
d = IC		H	O	P	S	T	C	D	E	M	V	W	R	K
(mm)	(in)													
3.97	5/32"				03	06		04			06	02		
4.76	3/16"				04	08	04	05	04	04	08	L3		
5.56	7/32"				05	09	05	06	05	05	09	03		
6.35	1/4"	03	02	04	08	11	06	07	08	08	11	04	06	
7.94	5/16"	04	03	05	07	13	08	09	06	07	13	05	07	
9.525	3/8"	05	04	07	09	16	09	11	09	09	16	06	09	16
12.7	1/2"	07	05	09	12	22	12	15	13	12	22	08	12	
15.875	5/8"	09	06	11	15	27	16	19	16	15	27	10	15	
19.05	3/4"	11	07	13	19	33	19	23	19	19	33	13	19	
25.40	1"	14	10	18	25	44	25	31	26	25	44	17	25	
31.75	1 1/4"	18	13	23	31	54	32	38	32	31	54	21	31	

6		7	
Tloušťka destičky		Rádus špičky destičky	
		RE	
		(mm)	(")
		00	0"
		02	0.2
		04	0.4
		08	0.8
		12	1.2
		16	1.6
		24	2.4
		32	3.2
		Kruhové destičky	
		d = I.C.	
		(")	00
		(mm)	M0

ANSI		
5	6	7
Vepsaná kružnice	Tloušťka destičky	Rádus špičky destičky
Symbol	d = I.C.	Symbol
	(mm)	(mm)
	(")	(")
1	3.175	1
	1/8"	1.588
1.2	3.969	1.2
	5/32"	1.984
1.5	4.763	1.5
	3/16"	2.381
1.8	5.556	2
	7/32"	3.175
2	6.350	2.5
	1/4"	3.969
2.5	7.938	3
	5/16"	4.763
3	9.525	3.5
	3/8"	5.556
4	12.700	4
	1/2"	6.350
5	15.875	5
	5/8"	7.938
6	19.050	6
	3/4"	9.525
7	22.225	7
	7/8"	11.113
8	25.400	8
	1"	12.700
10	31.750	9
	5/4"	14.288
12	38.100	10
	6/4"	15.875

8		8	
Provedení řezné hrany destičky			
	Ostré hrany		Zaoblené hrany
	Hrany s fazetkou		Zaoblené hrany s fazetkou
	Hrany s dvojitou fazetkou		Zaoblené hrany s dvojitou fazetkou

9		9	
Směr posuvu			
	Posuv		Posuv
	Posuv		Posuv
10		10	
Utvařec			



CCGT

	IC	D1	L	S
	(mm)	(mm)	(mm)	(mm)
0602	6.350	2.80	6.40	2.38
0602-SF3	6.350	2.80	6.40	2.58
0803-AL	7.940	3.40	8.10	3.43
0803-SF3	7.940	3.40	8.10	3.43
09T3	9.525	4.40	9.70	3.97
09T3-SF3	9.525	4.40	9.70	4.22
1204	12.700	5.50	12.90	4.76
1204-SF3	12.700	5.50	12.90	5.01

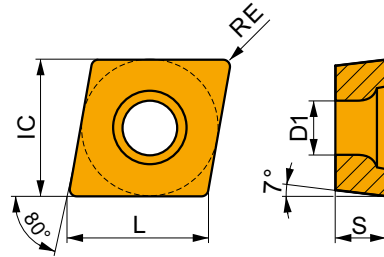

Startovní řezné podmínky, řezná rychlost (Vc), posuv (f) a hloubka řezu (Ap). Další výpočty naleznete v naší aplikaci Kalkulátor řezných podmínek.

Produkt	RE	P			M			K			N			S			H		
		vc	f	ap	vc	f	ap	vc	f	ap	vc	f	ap	vc	f	ap	vc	f	ap
	(mm)	(m/min)	(mm/rev)	(mm)	(m/min)	(mm/rev)	(mm)	(m/min)	(mm/rev)	(mm)	(m/min)	(mm/rev)	(mm)	(m/min)	(mm/rev)	(mm)	(m/min)	(mm/rev)	(mm)



AL je vysoce pozitivní geometrie pro jemné dokončování až hrubování, plynulý až mírně přerušovaný řez.

CCGT 060202F-AL	HF7	0.2	-	-	-	-	-	-	-	-	-	360	0.12	1.0	-	-	-	-	-	-
	T0315	0.2	-	-	-	-	-	-	-	-	-	360	0.12	1.0	-	-	-	-	-	-
CCGT 060204F-AL	HF7	0.4	-	-	-	-	-	-	-	-	-	300	0.24	1.0	-	-	-	-	-	-
	T0315	0.4	-	-	-	-	-	-	-	-	-	300	0.24	1.0	-	-	-	-	-	-
CCGT 080302F-AL	T0315	0.2	-	-	-	-	-	-	-	-	-	360	0.12	1.0	-	-	-	-	-	-
CCGT 080304F-AL	HF7	0.4	-	-	-	-	-	-	-	-	-	300	0.24	1.0	-	-	-	-	-	-
	T0315	0.4	-	-	-	-	-	-	-	-	-	300	0.24	1.0	-	-	-	-	-	-
CCGT 09T302F-AL	HF7	0.2	-	-	-	-	-	-	-	-	-	360	0.12	1.0	-	-	-	-	-	-
	T0315	0.2	-	-	-	-	-	-	-	-	-	360	0.12	1.0	-	-	-	-	-	-
CCGT 09T304F-AL	HF7	0.4	-	-	-	-	-	-	-	-	-	300	0.24	1.5	-	-	-	-	-	-
	T0315	0.4	-	-	-	-	-	-	-	-	-	300	0.24	1.5	-	-	-	-	-	-
CCGT 09T308F-AL	HF7	0.8	-	-	-	-	-	-	-	-	-	200	0.48	1.5	-	-	-	-	-	-
	T0315	0.8	-	-	-	-	-	-	-	-	-	200	0.48	1.5	-	-	-	-	-	-
CCGT 120404F-AL	HF7	0.4	-	-	-	-	-	-	-	-	-	300	0.24	2.4	-	-	-	-	-	-
	T0315	0.4	-	-	-	-	-	-	-	-	-	300	0.24	2.4	-	-	-	-	-	-
CCGT 120408F-AL	HF7	0.8	-	-	-	-	-	-	-	-	-	200	0.48	2.4	-	-	-	-	-	-
	T0315	0.8	-	-	-	-	-	-	-	-	-	200	0.48	2.4	-	-	-	-	-	-

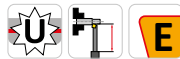
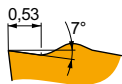

FF2 je pozitivní geometrie pro jemné a dokončovací operace, plynulý až mírně přerušovaný řez.

CCGT 09T302E-FF2	T7325	0.2	150	0.05	1.0	-	-	-	-	-	-	-	-	-	-	-	-	-	-	-
	T9325	0.2	150	0.05	1.0	-	-	-	115	0.05	1.0	-	-	-	-	-	-	-	-	-

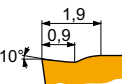

NF1 je pozitivní geometrie pro jemné dokončovací až střední operace a plynulý řez.

CCGT 060204E-NF1	T6310	0.4	140	0.10	0.8	110	0.09	0.8	-	-	-	360	0.12	0.8	38	0.07	0.6	25	0.15	1.0
	T7325	0.4	140	0.10	0.8	110	0.09	0.8	-	-	-	-	-	-	45	0.07	0.6	-	-	-
CCGT 060208E-NF1	T6310	0.8	140	0.12	0.8	110	0.11	0.8	-	-	-	360	0.14	0.8	45	0.11	0.6	30	0.15	1.0
	T7325	0.8	140	0.12	0.8	110	0.11	0.8	-	-	-	-	-	-	45	0.11	0.6	-	-	-
CCGT 09T304E-NF1	T6310	0.4	140	0.10	1.2	110	0.09	1.2	-	-	-	360	0.12	1.2	38	0.07	1.0	25	0.15	1.0
	T7325	0.4	140	0.10	1.2	110	0.09	1.2	-	-	-	-	-	-	45	0.07	1.0	-	-	-
CCGT 09T308E-NF1	T6310	0.8	140	0.14	1.2	100	0.13	1.2	-	-	-	330	0.17	1.2	41	0.13	1.0	25	0.15	1.0
	T7325	0.8	140	0.14	1.2	100	0.13	1.2	-	-	-	-	-	-	45	0.13	1.0	-	-	-



Startovní řezné podmínky, řezná rychlost (Vc), posuv (f) a hloubka řezu (Ap). Další výpočty naleznete v naší aplikaci Kalkulátor řezných podmínek.

Produkt	RE (mm)	P			M			K			N			S			H		
		vc (m/min)	f (mm/rev)	ap (mm)	vc (m/min)	f (mm/rev)	ap (mm)	vc (m/min)	f (mm/rev)	ap (mm)	vc (m/min)	f (mm/rev)	ap (mm)	vc (m/min)	f (mm/rev)	ap (mm)	vc (m/min)	f (mm/rev)	ap (mm)

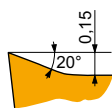

SF3 je vysoce pozitivní geometrie pro jemné a dokončovací operace a plynulý řez.

CCGT 060202E-SF3	H07	0.2	–	–	–	110	0.05	0.8	115	0.05	0.8	360	0.06	0.8	45	0.04	0.6	–	–	–
	T6310	0.2	150	0.05	0.8	110	0.05	0.8	115	0.05	0.8	360	0.06	0.8	45	0.04	0.6	30	0.15	1.0
	T8315	0.2	150	0.05	0.8	110	0.05	0.8	115	0.05	0.8	360	0.06	0.8	38	0.04	0.6	30	0.15	1.0
CCGT 060204E-SF3	H07	0.4	–	–	–	95	0.09	0.8	115	0.10	0.8	360	0.12	0.8	34	0.07	0.6	–	–	–
	T6310	0.4	140	0.10	0.8	110	0.09	0.8	115	0.10	0.8	360	0.12	0.8	38	0.07	0.6	26	0.15	1.0
	T8315	0.4	140	0.10	0.8	110	0.09	0.8	115	0.10	0.8	360	0.12	0.8	34	0.07	0.6	26	0.15	1.0
CCGT 080302E-SF3	T6310	0.2	150	0.05	0.8	110	0.05	0.8	115	0.05	0.8	360	0.06	0.8	45	0.04	0.6	30	0.15	1.0
	T8315	0.2	150	0.05	0.8	110	0.05	0.8	115	0.05	0.8	360	0.06	0.8	38	0.04	0.6	30	0.15	1.0
	H07	0.4	–	–	–	95	0.09	1.0	115	0.10	1.0	360	0.12	1.0	34	0.07	0.8	–	–	–
CCGT 080304E-SF3	T6310	0.4	140	0.10	1.0	110	0.09	1.0	115	0.10	1.0	360	0.12	1.0	38	0.07	0.8	26	0.15	1.0
	T8315	0.4	140	0.10	1.0	110	0.09	1.0	115	0.10	1.0	360	0.12	1.0	34	0.07	0.8	26	0.15	1.0
	H07	0.8	–	–	–	110	0.09	1.0	115	0.10	1.0	360	0.12	1.0	41	0.08	0.8	–	–	–
CCGT 09T302E-SF3	H07	0.2	–	–	–	110	0.05	0.8	115	0.05	0.8	360	0.06	0.8	45	0.04	0.6	–	–	–
	T6310	0.2	150	0.05	0.8	110	0.05	0.8	115	0.05	0.8	360	0.06	0.8	45	0.04	0.6	30	0.15	1.0
	T8315	0.2	150	0.05	0.8	110	0.05	0.8	115	0.05	0.8	360	0.06	0.8	38	0.04	0.6	30	0.15	1.0
CCGT 09T304E-SF3	H07	0.4	–	–	–	95	0.09	1.0	115	0.10	1.0	360	0.12	1.0	34	0.07	0.8	–	–	–
	T6310	0.4	140	0.10	1.0	110	0.09	1.0	115	0.10	1.0	360	0.12	1.0	38	0.07	0.8	26	0.15	1.0
	T8315	0.4	140	0.10	1.0	110	0.09	1.0	115	0.10	1.0	360	0.12	1.0	34	0.07	0.8	26	0.15	1.0
CCGT 09T308E-SF3	H07	0.8	–	–	–	110	0.09	1.0	115	0.10	1.0	360	0.12	1.0	41	0.08	0.8	–	–	–
	T6310	0.8	140	0.10	1.0	110	0.09	1.0	115	0.10	1.0	360	0.12	1.0	45	0.08	0.8	30	0.15	1.0
	T8315	0.8	140	0.10	1.0	110	0.09	1.0	115	0.10	1.0	360	0.12	1.0	41	0.08	0.8	34	0.15	1.0
CCGT 120408E-SF3	H07	0.8	–	–	–	105	0.12	1.0	110	0.12	1.0	360	0.14	1.0	38	0.11	0.8	–	–	–
	T6310	0.8	140	0.12	1.0	110	0.12	1.0	110	0.12	1.0	360	0.14	1.0	45	0.11	0.8	30	0.15	1.0
	T8315	0.8	140	0.12	1.0	110	0.12	1.0	110	0.12	1.0	360	0.14	1.0	38	0.11	0.8	30	0.15	1.0

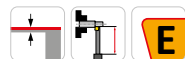

EL-SI je pozitivní geometrie v levostranném provedení pro jemné dokončování a plynulý řez.

CCGT 060202EL-SI	T8330	0.2	140	0.10	0.8	110	0.09	0.8	115	0.10	0.8	–	–	–	38	0.08	0.6	–	–	–
	T8430	0.2	140	0.10	0.8	110	0.09	0.8	115	0.10	0.8	–	–	–	38	0.08	0.6	–	–	–
CCGT 060204EL-SI	T8315	0.4	140	0.12	0.8	110	0.11	0.8	110	0.12	0.8	–	–	–	41	0.10	0.6	–	–	–
	T8330	0.4	140	0.12	0.8	110	0.11	0.8	110	0.12	0.8	–	–	–	38	0.10	0.6	–	–	–
CCGT 09T304EL-SI	T8430	0.4	140	0.12	0.8	110	0.11	0.8	110	0.12	0.8	–	–	–	38	0.10	0.6	–	–	–
	T8315	0.4	130	0.17	0.8	100	0.15	0.8	105	0.17	0.8	–	–	–	38	0.15	0.6	–	–	–
CCGT 120408EL-SI	T8330	0.4	130	0.17	0.8	100	0.15	0.8	105	0.17	0.8	–	–	–	34	0.15	0.6	–	–	–
	T8430	0.4	130	0.17	0.8	100	0.15	0.8	105	0.17	0.8	–	–	–	34	0.15	0.6	–	–	–
	T8330	0.8	130	0.23	1.0	95	0.21	1.0	95	0.23	1.0	–	–	–	38	0.21	0.8	–	–	–
T8430	0.8	130	0.24	1.0	95	0.22	1.0	95	0.24	1.0	–	–	–	34	0.22	0.8	–	–	–	



CCGW CBN

PRAMET

	IC (mm)	D1 (mm)	L (mm)	S (mm)
0602	6.350	2.80	6.50	2.38
09T3	9.525	4.50	9.70	3.97

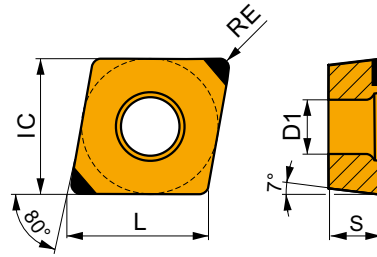

Startovní řezné podmínky, řezná rychlost (Vc), posuv (f) a hloubka řezu (Ap). Další výpočty naleznete v naší aplikaci Kalkulátor řezných podmínek.

Produkt	RE	P			M			K			N			S			H		
		vc (m/min)	f (mm/rev)	ap (mm)	vc (m/min)	f (mm/rev)	ap (mm)	vc (m/min)	f (mm/rev)	ap (mm)	vc (m/min)	f (mm/rev)	ap (mm)	vc (m/min)	f (mm/rev)	ap (mm)	vc (m/min)	f (mm/rev)	ap (mm)

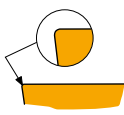

Pro dokončovací operace.

CCGW 060204E-B	TB310	0.4	-	-	-	-	-	-	115	0.10	0.4	-	-	-	90	0.07	0.3	70	0.15	1.0
CCGW 09T304E-B	TB310	0.4	-	-	-	-	-	-	115	0.10	0.4	-	-	-	90	0.07	0.3	70	0.15	1.0

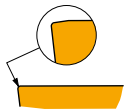

Pro dokončovací operace.

CCGW 060204S01020B	TB310	0.4	-	-	-	-	-	-	115	0.10	0.4	-	-	-	90	0.07	0.3	70	0.15	1.0
CCGW 09T304S01020B	TB310	0.4	-	-	-	-	-	-	115	0.10	0.4	-	-	-	90	0.07	0.3	70	0.15	1.0

CCMT

PRAMET

	IC (mm)	D1 (mm)	L (mm)	S (mm)
0602	6.350	2.80	6.40	2.38
0803	7.940	3.40	8.10	3.18
09T3	9.525	4.40	9.70	3.97
1204	12.700	5.50	12.90	4.76

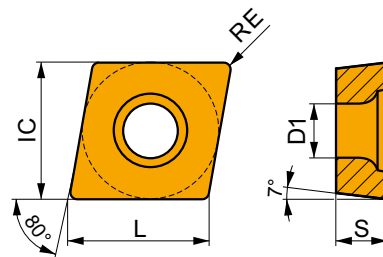

Startovní řezné podmínky, řezná rychlost (Vc), posuv (f) a hloubka řezu (Ap). Další výpočty naleznete v naší aplikaci Kalkulátor řezných podmínek.

Produkt	RE	P			M			K			N			S			H		
		vc (m/min)	f (mm/rev)	ap (mm)	vc (m/min)	f (mm/rev)	ap (mm)	vc (m/min)	f (mm/rev)	ap (mm)	vc (m/min)	f (mm/rev)	ap (mm)	vc (m/min)	f (mm/rev)	ap (mm)	vc (m/min)	f (mm/rev)	ap (mm)

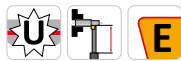
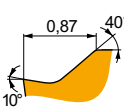

FF je pozitivní geometrie pro jemné a dokončovací operace, plynulý až mírně přerušovaný řez.

CCMT 060202E-FF	T8330	0.2	140	0.10	1.0	110	0.09	1.0	-	-	-	-	-	-	-	-	-	-	-	-
	T8430	0.2	140	0.10	1.0	110	0.09	1.0	-	-	-	-	-	-	-	-	-	-	-	-
CCMT 060204E-FF	T8330	0.4	140	0.12	1.0	110	0.11	1.0	-	-	-	-	-	-	-	-	-	-	-	-
	T8430	0.4	140	0.12	1.0	110	0.11	1.0	-	-	-	-	-	-	-	-	-	-	-	-
CCMT 09T304E-FF	T8330	0.4	140	0.12	1.2	110	0.11	1.2	-	-	-	-	-	-	-	-	-	-	-	-
	T8430	0.4	140	0.12	1.2	110	0.11	1.2	-	-	-	-	-	-	-	-	-	-	-	-



Startovní řezné podmínky, řezná rychlost (Vc), posuv (f) a hloubka řezu (Ap). Další výpočty naleznete v naší aplikaci Kalkulátor řezných podmínek.

Produkt	RE (mm)	P			M			K			N			S			H		
		vc (m/min)	f (mm/rev)	ap (mm)	vc (m/min)	f (mm/rev)	ap (mm)	vc (m/min)	f (mm/rev)	ap (mm)	vc (m/min)	f (mm/rev)	ap (mm)	vc (m/min)	f (mm/rev)	ap (mm)	vc (m/min)	f (mm/rev)	ap (mm)

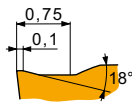

FM2 je geometrie pro dokončovací až střední operace, plynulý až přerušovaný řez.

CCMT 080304E-FM2	T8330	0.4	140	0.12	1.0	95	0.11	1.0	110	0.12	1.0	-	-	-	-	-	-	-
	T8430	0.4	140	0.12	1.0	105	0.11	1.0	110	0.12	1.0	-	-	-	-	-	-	-
	T9325	0.4	140	0.12	1.0	110	0.11	1.0	110	0.12	1.0	-	-	-	-	-	-	-
CCMT 080308E-FM2	T8330	0.8	130	0.17	1.0	100	0.15	1.0	105	0.17	1.0	-	-	-	-	-	-	-
	T8430	0.8	130	0.17	1.0	100	0.15	1.0	105	0.17	1.0	-	-	-	-	-	-	-
	T9325	0.8	130	0.17	1.0	100	0.15	1.0	105	0.17	1.0	-	-	-	-	-	-	-
CCMT 09T304E-FM2	T8330	0.4	140	0.12	1.0	95	0.11	1.0	110	0.12	1.0	-	-	-	-	-	-	-
	T8430	0.4	140	0.12	1.0	105	0.11	1.0	110	0.12	1.0	-	-	-	-	-	-	-
	T9325	0.4	140	0.12	1.0	110	0.11	1.0	110	0.12	1.0	-	-	-	-	-	-	-
CCMT 09T308E-FM2	T8330	0.8	130	0.17	1.0	100	0.15	1.0	105	0.17	1.0	-	-	-	-	-	-	-
	T8430	0.8	130	0.17	1.0	100	0.15	1.0	105	0.17	1.0	-	-	-	-	-	-	-
	T9325	0.8	130	0.17	1.0	100	0.15	1.0	105	0.17	1.0	-	-	-	-	-	-	-
CCMT 120408E-FM2	T8330	0.8	130	0.20	1.5	95	0.18	1.5	100	0.20	1.5	-	-	-	-	-	-	-
	T8430	0.8	130	0.20	1.5	95	0.18	1.5	100	0.20	1.5	-	-	-	-	-	-	-
	T9325	0.8	130	0.20	1.5	100	0.18	1.5	100	0.20	1.5	-	-	-	-	-	-	-

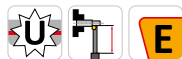

NF2 je pozitivní geometrie pro jemné dokončovací až polohrubovací operace a plynulý řez.

CCMT 060202E-NF2	T6310	0.2	140	0.10	0.8	110	0.09	0.8	115	0.10	0.8	360	0.12	0.8	38	0.08	0.6	-	-	-
	T9325	0.2	140	0.10	0.8	110	0.09	0.8	115	0.10	0.8	-	-	-	41	0.08	0.6	-	-	-
CCMT 060204E-NF2	H07	0.4	-	-	-	85	0.11	0.8	110	0.12	0.8	360	0.14	0.8	34	0.11	0.6	-	-	-
	T6310	0.4	140	0.12	0.8	110	0.11	0.8	110	0.12	0.8	360	0.14	0.8	38	0.11	0.6	-	-	-
	T9325	0.4	140	0.12	0.8	110	0.11	0.8	110	0.12	0.8	-	-	-	41	0.11	0.6	-	-	-
CCMT 080304E-NF2	T9325	0.4	140	0.12	1.0	110	0.11	1.0	110	0.12	1.0	-	-	-	41	0.11	0.8	-	-	-
CCMT 080308E-NF2	T9325	0.8	130	0.17	1.0	100	0.15	1.0	105	0.17	1.0	-	-	-	41	0.14	0.8	-	-	-
CCMT 09T304E-NF2	H07	0.4	-	-	-	85	0.11	1.2	110	0.12	1.2	360	0.14	1.2	30	0.11	1.0	-	-	-
	T6310	0.4	140	0.12	1.2	110	0.11	1.2	110	0.12	1.2	360	0.14	1.2	34	0.11	1.0	-	-	-
	T9325	0.4	140	0.12	1.2	110	0.11	1.2	110	0.12	1.2	-	-	-	41	0.11	1.0	-	-	-
CCMT 09T308E-NF2	T6310	0.8	140	0.14	1.2	100	0.13	1.2	110	0.14	1.2	330	0.17	1.2	41	0.13	1.0	-	-	-
	T9325	0.8	140	0.14	1.2	100	0.13	1.2	110	0.14	1.2	-	-	-	45	0.13	1.0	-	-	-

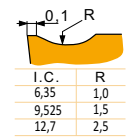

RF je geometrie pro polohrubovací až hrubovací operace, plynulý až přerušovaný řez.

CCMT 060202E-RF	T7335	0.2	140	0.15	1.0	100	0.14	1.0	-	-	-	-	-	-	-	-	-	-	-	
CCMT 060204E-RF	T5315	0.4	140	0.15	1.0	-	-	-	110	0.15	1.0	-	-	-	-	-	-	35	0.15	1.0
	T7335	0.4	140	0.15	1.0	100	0.15	1.0	-	-	-	-	-	-	-	-	-	-	-	
CCMT 09T304E-RF	T7335	0.4	130	0.20	1.5	100	0.18	1.5	-	-	-	-	-	-	-	-	-	-	-	
CCMT 09T308E-RF	T5315	0.8	130	0.20	1.5	-	-	-	100	0.20	1.5	-	-	-	-	-	-	35	0.15	1.0
	T7335	0.8	130	0.20	1.5	100	0.18	1.5	-	-	-	-	-	-	-	-	-	-	-	
CCMT 120408E-RF	T5315	0.8	130	0.22	2.2	-	-	-	100	0.22	2.2	-	-	-	-	-	-	35	0.15	1.0
	T7335	0.8	130	0.22	2.2	95	0.22	2.2	-	-	-	-	-	-	-	-	-	-	-	

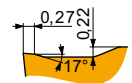
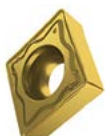

RM je geometrie pro polohrubovací až hrubovací operace, plynulý až přerušovaný řez.

CCMT 09T304E-RM	T8330	0.4	120	0.27	2.2	80	0.24	2.2	95	0.27	2.2	-	-	-	26	0.19	1.8	20	0.15	1.0
	T8430	0.4	120	0.27	2.2	75	0.24	2.2	95	0.27	2.2	-	-	-	23	0.19	1.8	19	0.15	1.0
	T9325	0.4	120	0.27	2.2	95	0.24	2.2	95	0.27	2.2	-	-	-	30	0.19	1.8	-	-	-
CCMT 09T308E-RM	T8330	0.8	120	0.30	2.2	90	0.27	2.2	90	0.30	2.2	-	-	-	30	0.24	1.8	23	0.15	1.0
	T8430	0.8	120	0.30	2.2	90	0.27	2.2	90	0.30	2.2	-	-	-	26	0.24	1.8	23	0.15	1.0
	T9325	0.8	120	0.30	2.2	90	0.27	2.2	90	0.30	2.2	-	-	-	34	0.24	1.8	-	-	-



Startovní řezné podmínky, řezná rychlost (Vc), posuv (f) a hloubka řezu (Ap). Další výpočty naleznete v naší aplikaci Kalkulátor řezných podmínek.

Produkt	RE (mm)	P			M			K			N			S			H		
		vc (m/min)	f (mm/rev)	ap (mm)	vc (m/min)	f (mm/rev)	ap (mm)	vc (m/min)	f (mm/rev)	ap (mm)	vc (m/min)	f (mm/rev)	ap (mm)	vc (m/min)	f (mm/rev)	ap (mm)	vc (m/min)	f (mm/rev)	ap (mm)

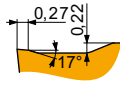
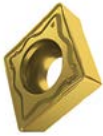

RM je geometrie pro polohrubovací až hrubovací operace, plynulý až přerušovaný řez.

CCMT 120408E-RM	T8330	0.8	120	0.30	2.7	90	0.27	2.7	90	0.30	2.7	-	-	-	30	0.24	2.2	23	0.15	1.0
	T8430	0.8	120	0.30	2.7	90	0.27	2.7	90	0.30	2.7	-	-	-	26	0.24	2.2	23	0.15	1.0
	T9325	0.8	120	0.30	2.7	90	0.27	2.7	90	0.30	2.7	-	-	-	34	0.24	2.2	-	-	-

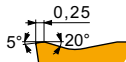

RM3 je geometrie pro polohrubovací až hrubovací operace, plynulý až přerušovaný řez.

CCMT 120404E-RM3	T9325	0.4	120	0.25	2.5	95	0.25	2.5	95	0.25	2.5	-	-	-	-	-	-	-	-	-
CCMT 120408E-RM3	T6310	0.8	120	0.27	2.5	90	0.27	2.5	95	0.27	2.5	-	-	-	-	-	-	19	0.15	1.0
	T9325	0.8	120	0.27	2.5	90	0.27	2.5	95	0.27	2.5	-	-	-	-	-	-	-	-	-

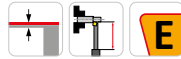
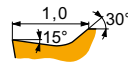

UR je geometrie pro jemné a dokončovací operace a plynulý až mírně přerušovaný řez.

CCMT 060202E-UR	T8330	0.2	140	0.10	0.8	95	0.09	0.8	115	0.10	0.8	-	-	-	-	-	-	-	-	-
	TT310	0.2	140	0.10	0.5	110	0.09	0.5	-	-	-	-	-	-	-	-	-	-	-	-
CCMT 060204E-UR	T8330	0.4	140	0.15	1.0	90	0.14	1.0	110	0.15	1.0	-	-	-	-	-	-	-	-	-
	TT310	0.4	140	0.15	0.5	100	0.14	0.5	-	-	-	-	-	-	-	-	-	-	-	-
CCMT 060208E-UR	T8330	0.8	130	0.20	1.0	95	0.18	1.0	100	0.20	1.0	-	-	-	-	-	-	-	-	-
CCMT 09T302E-UR	TT310	0.2	140	0.10	1.0	110	0.09	1.0	-	-	-	-	-	-	-	-	-	-	-	-
CCMT 09T304E-UR	T8330	0.4	140	0.15	1.2	90	0.14	1.2	110	0.15	1.2	-	-	-	-	-	-	-	-	-
	TT310	0.4	140	0.15	1.2	100	0.14	1.2	-	-	-	-	-	-	-	-	-	-	-	-
CCMT 09T308E-UR	T8330	0.8	130	0.20	1.2	95	0.18	1.2	100	0.20	1.2	-	-	-	-	-	-	-	-	-
	TT310	0.8	130	0.20	1.2	100	0.18	1.2	-	-	-	-	-	-	-	-	-	-	-	-
CCMT 120404E-UR	T8330	0.4	140	0.15	1.7	80	0.14	1.7	110	0.15	1.7	-	-	-	-	-	-	-	-	-
CCMT 120408E-UR	T8330	0.8	130	0.20	1.7	90	0.18	1.7	100	0.20	1.7	-	-	-	-	-	-	-	-	-

CCMW



	IC (mm)	D1 (mm)	L (mm)	S (mm)
0602	6.350	2.80	6.40	2.38
09T3	9.525	4.40	9.70	3.97
1204	12.700	5.50	12.90	4.76

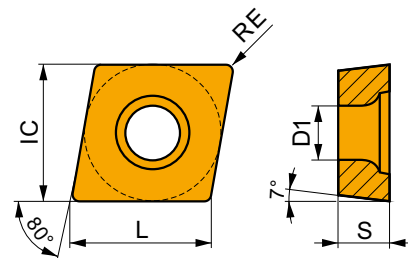

Startovní řezné podmínky, řezná rychlost (Vc), posuv (f) a hloubka řezu (Ap). Další výpočty naleznete v naší aplikaci Kalkulátor řezných podmínek.

Produkt	RE (mm)	P			M			K			N			S			H		
		vc (m/min)	f (mm/rev)	ap (mm)	vc (m/min)	f (mm/rev)	ap (mm)	vc (m/min)	f (mm/rev)	ap (mm)	vc (m/min)	f (mm/rev)	ap (mm)	vc (m/min)	f (mm/rev)	ap (mm)	vc (m/min)	f (mm/rev)	ap (mm)

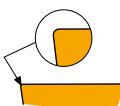

Pro jemné dokončovací až polohrubovací operace, plynulý až mírně přerušovaný řez.

CCMW 060204	T5315	0.4	-	-	-	-	-	-	115	0.10	2.0	-	-	-	-	-	-	30	0.15	1.0
CCMW 09T304	T5315	0.4	-	-	-	-	-	-	115	0.10	3.0	-	-	-	-	-	-	30	0.15	1.0
CCMW 09T308	T5315	0.8	-	-	-	-	-	-	100	0.20	3.0	-	-	-	-	-	-	26	0.15	1.0



Startovní řezné podmínky, řezná rychlost (Vc), posuv (f) a hloubka řezu (Ap). Další výpočty naleznete v naší aplikaci Kalkulátor řezných podmínek.

Produkt	RE (mm)	P			M			K			N			S			H		
		vc (m/min)	f (mm/rev)	ap (mm)	vc (m/min)	f (mm/rev)	ap (mm)	vc (m/min)	f (mm/rev)	ap (mm)	vc (m/min)	f (mm/rev)	ap (mm)	vc (m/min)	f (mm/rev)	ap (mm)	vc (m/min)	f (mm/rev)	ap (mm)

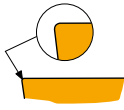

Pro jemné dokončovací až polohrubovací operace, plynulý až mírně přerušovaný řez.

CCMW 120404	T5315	0.4	-	-	-	-	-	-	115	0.10	4.0	-	-	-	-	-	-	26	0.15	1.0
CCMW 120408	T5315	0.8	-	-	-	-	-	-	100	0.20	4.0	-	-	-	-	-	-	26	0.15	1.0

CNGA CBN

PRAMET

	IC (mm)	D1 (mm)	L (mm)	S (mm)
1204	12.700	5.16	12.90	4.76

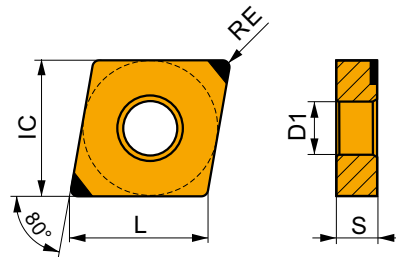

Startovní řezné podmínky, řezná rychlost (Vc), posuv (f) a hloubka řezu (Ap). Další výpočty naleznete v naší aplikaci Kalkulátor řezných podmínek.

Produkt	RE (mm)	P			M			K			N			S			H		
		vc (m/min)	f (mm/rev)	ap (mm)	vc (m/min)	f (mm/rev)	ap (mm)	vc (m/min)	f (mm/rev)	ap (mm)	vc (m/min)	f (mm/rev)	ap (mm)	vc (m/min)	f (mm/rev)	ap (mm)	vc (m/min)	f (mm/rev)	ap (mm)

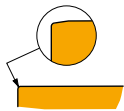

Pro dokončovací operace a plynulý řez.

CNGA 120404S01020B	TB310	0.4	-	-	-	-	-	-	115	0.10	0.4	-	-	-	100	0.07	0.3	80	0.15	1.0
CNGA 120408S01020B	TB310	0.8	-	-	-	-	-	-	110	0.15	0.6	-	-	-	100	0.11	0.5	85	0.15	1.0



CNGG

	IC	D1	L	S
	(mm)	(mm)	(mm)	(mm)
1204	12.700	5.16	12.90	4.76

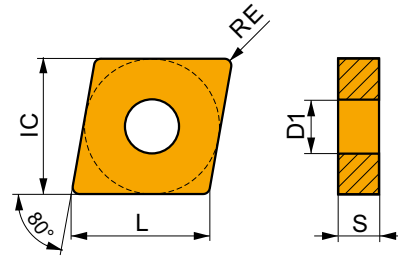

Startovní řezné podmínky, řezná rychlost (Vc), posuv (f) a hloubka řezu (Ap). Další výpočty naleznete v naší aplikaci Kalkulátor řezných podmínek.

Produkt	RE	P			M			K			N			S			H		
		vc	f	ap	vc	f	ap	vc	f	ap	vc	f	ap	vc	f	ap	vc	f	ap
	(mm)	(m/min)	(mm/rev)	(mm)	(m/min)	(mm/rev)	(mm)	(m/min)	(mm/rev)	(mm)	(m/min)	(mm/rev)	(mm)	(m/min)	(mm/rev)	(mm)	(m/min)	(mm/rev)	(mm)

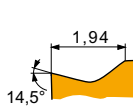

SF je pozitivní geometrie pro jemné dokončování, obrábění tenkostěnných dílů a plynulý řez.

CNGG 120402E-SF	H07	0.2	–	–	–	105	0.09	1.0	115	0.10	1.0	360	0.12	1.0	38	0.08	0.8	–	–	–
	T6310	0.2	140	0.10	1.0	110	0.09	1.0	115	0.10	1.0	360	0.12	1.0	41	0.08	0.8	26	0.15	1.0
	T8330	0.2	140	0.10	1.0	110	0.09	1.0	115	0.10	1.0	360	0.12	1.0	34	0.08	0.8	26	0.15	1.0
	T8430	0.2	140	0.10	1.0	110	0.09	1.0	115	0.10	1.0	360	0.12	1.0	34	0.08	0.8	30	0.15	1.0

CNMA

	IC	D1	L	S
	(mm)	(mm)	(mm)	(mm)
1204	12.700	5.16	12.90	4.76

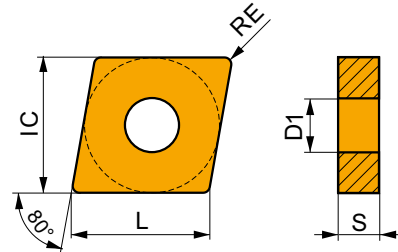

Startovní řezné podmínky, řezná rychlost (Vc), posuv (f) a hloubka řezu (Ap). Další výpočty naleznete v naší aplikaci Kalkulátor řezných podmínek.

Produkt	RE	P			M			K			N			S			H		
		vc	f	ap	vc	f	ap	vc	f	ap	vc	f	ap	vc	f	ap	vc	f	ap
	(mm)	(m/min)	(mm/rev)	(mm)	(m/min)	(mm/rev)	(mm)	(m/min)	(mm/rev)	(mm)	(m/min)	(mm/rev)	(mm)	(m/min)	(mm/rev)	(mm)	(m/min)	(mm/rev)	(mm)

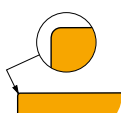

Pro jemné dokončovací až polohrubovací operace, plynulý až mírně přerušovaný řez.

CNMA 120404	T5315	0.4	–	–	–	–	–	–	115	0.10	4.0	–	–	–	–	–	–	30	0.15	1.0
CNMA 120408	T5315	0.8	–	–	–	–	–	–	100	0.20	4.0	–	–	–	–	–	–	30	0.15	1.0
CNMA 120412	T5315	1.2	–	–	–	–	–	–	90	0.30	4.0	–	–	–	–	–	–	25	0.15	1.0



CNMG

	IC	D1	L	S
	(mm)	(mm)	(mm)	(mm)
1204	12.700	5.16	12.90	4.76

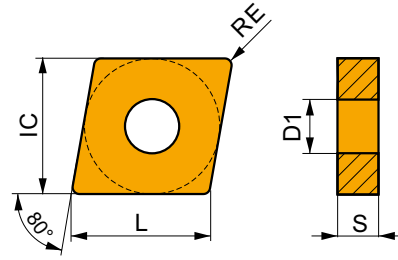

Startovní řezné podmínky, řezná rychlost (Vc), posuv (f) a hloubka řezu (Ap). Další výpočty naleznete v naší aplikaci Kalkulátor řezných podmínek.

Produkt	RE	P			M			K			N			S			H		
		vc	f	ap	vc	f	ap	vc	f	ap	vc	f	ap	vc	f	ap	vc	f	ap
	(mm)	(m/min)	(mm/rev)	(mm)	(m/min)	(mm/rev)	(mm)	(m/min)	(mm/rev)	(mm)	(m/min)	(mm/rev)	(mm)	(m/min)	(mm/rev)	(mm)	(m/min)	(mm/rev)	(mm)

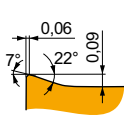

FF je vysoce pozitivní geometrie pro jemné dokončování, plynulý až mírně přerušovaný řez.

CNMG 120404E-FF	T7325	0.4	✓	140	0.12	1.0	■	110	0.11	1.0	—	—	—	—	—	—	—	—	—	—
	T8315	0.4	✓	140	0.12	1.0	■	110	0.11	1.0	✓	110	0.12	1.0	—	—	—	—	—	—
CNMG 120408E-FF	T7325	0.8	✓	140	0.15	1.0	■	100	0.14	1.0	—	—	—	—	—	—	—	—	—	—
	T8315	0.8	✓	140	0.15	1.0	■	100	0.14	1.0	✓	110	0.15	1.0	—	—	—	—	—	—

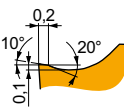

FM je pozitivní geometrie pro dokončovací až polohrubovací operace, plynulý až mírně přerušovaný řez.

CNMG 120404E-FM	T9325	0.4	■	130	0.20	2.1	✓	100	0.18	2.1	✓	100	0.20	2.1	—	—	—	✓	38	0.16	1.7	—	—	—
	TT310	0.4	■	130	0.20	2.1	✓	100	0.18	2.1	—	—	—	—	—	—	—	—	—	—	—	—	—	—
CNMG 120408E-FM	T9325	0.8	■	130	0.20	2.1	✓	100	0.18	2.1	✓	100	0.20	2.1	—	—	—	✓	45	0.16	1.7	—	—	—
	TT310	0.8	■	130	0.20	2.1	✓	100	0.18	2.1	—	—	—	—	—	—	—	—	—	—	—	—	—	—

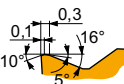

M je geometrie pro dokončovací až polohrubovací operace, plynulý až přerušovaný řez.

CNMG 120404E-M	T5315	0.4	✓	130	0.20	2.1	—	—	—	■	100	0.20	2.1	—	—	—	—	—	—	—	✓	35	0.15	1.0
	T9325	0.4	■	130	0.20	2.1	—	—	—	✓	100	0.20	2.1	—	—	—	—	—	—	—	—	—	—	—
CNMG 120408E-M	T5315	0.8	✓	120	0.32	2.1	—	—	—	■	90	0.32	2.1	—	—	—	—	—	—	—	✓	38	0.15	1.0
	T9325	0.8	■	120	0.32	2.1	—	—	—	✓	90	0.32	2.1	—	—	—	—	—	—	—	—	—	—	—

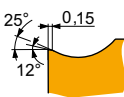

NF je vysoce pozitivní geometrie pro jemné dokončovací až střední operace a plynulý řez.

CNMG 120404E-NF	T7325	0.4	✓	130	0.18	1.7	■	100	0.16	1.7	—	—	—	—	—	—	—	✓	45	0.16	1.4	—	—	—	
	T8330	0.4	■	130	0.17	1.7	■	100	0.15	1.7	✓	105	0.17	1.7	✓	330	0.20	1.7	✓	34	0.14	1.4	—	—	—
	T8430	0.4	■	130	0.17	1.7	■	100	0.15	1.7	✓	105	0.17	1.7	✓	330	0.20	1.7	✓	30	0.14	1.4	—	—	—
CNMG 120408E-NF	T7325	0.8	✓	130	0.19	1.7	■	100	0.17	1.7	—	—	—	—	—	—	—	—	✓	45	0.15	1.4	—	—	—
	T8330	0.8	■	130	0.19	1.7	■	100	0.17	1.7	✓	100	0.19	1.7	✓	300	0.23	1.7	✓	38	0.15	1.4	—	—	—
	T8430	0.8	■	130	0.19	1.7	■	100	0.17	1.7	✓	100	0.19	1.7	✓	300	0.23	1.7	✓	34	0.15	1.4	—	—	—

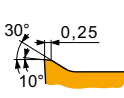

NM je vysoce pozitivní geometrie pro jemné dokončovací až hrubovací operace a plynulý řez.

CNMG 120404E-NM	T7325	0.4	✓	130	0.20	2.1	■	100	0.18	2.1	—	—	—	—	—	—	—	—	—	—	■	45	0.16	1.7	—	—	—
	T8330	0.4	■	130	0.20	2.1	■	100	0.18	2.1	—	—	—	✓	300	0.24	2.1	✓	30	0.16	1.7	—	—	—	—	—	
	T8430	0.4	■	130	0.20	2.1	■	100	0.18	2.1	—	—	—	✓	300	0.24	2.1	✓	30	0.16	1.7	—	—	—	—	—	



Startovní řezné podmínky, řezná rychlost (Vc), posuv (f) a hloubka řezu (Ap). Další výpočty naleznete v naší aplikaci Kalkulátor řezných podmínek.

Produkt	RE (mm)	P			M			K			N			S			H		
		vc (m/min)	f (mm/rev)	ap (mm)	vc (m/min)	f (mm/rev)	ap (mm)	vc (m/min)	f (mm/rev)	ap (mm)	vc (m/min)	f (mm/rev)	ap (mm)	vc (m/min)	f (mm/rev)	ap (mm)	vc (m/min)	f (mm/rev)	ap (mm)

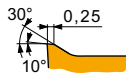

NM je vysoce pozitivní geometrie pro jemné dokončovací až hrubovací operace a plynulý řez.

CNMG 120408E-NM	T7325	0.8	120	0.25	2.1	95	0.23	2.1	-	-	-	-	-	-	45	0.20	1.7	-	-	-
	T8330	0.8	120	0.25	2.1	95	0.23	2.1	-	-	-	270	0.30	2.1	34	0.20	1.7	-	-	-
	T8430	0.8	120	0.25	2.1	95	0.23	2.1	-	-	-	270	0.30	2.1	30	0.20	1.7	-	-	-

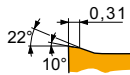

NMR je pozitivní geometrie pro střední až hrubovací operace a plynulý řez.

CNMG 120404E-NMR	T7325	0.4	120	0.25	2.7	95	0.23	2.7	-	-	-	-	-	38	0.20	2.2	-	-	-
	T8330	0.4	120	0.25	2.0	80	0.23	2.0	-	-	-	-	-	26	0.20	1.6	-	-	-
	T8430	0.4	120	0.25	2.7	75	0.23	2.7	-	-	-	-	-	23	0.20	2.2	-	-	-
CNMG 120408E-NMR	T7325	0.8	120	0.35	2.7	90	0.32	2.7	-	-	-	-	-	41	0.25	2.2	-	-	-
	T8330	0.8	120	0.35	2.7	90	0.32	2.7	-	-	-	-	-	26	0.25	2.2	-	-	-
	T8430	0.8	120	0.35	2.7	80	0.32	2.7	-	-	-	-	-	23	0.25	2.2	-	-	-

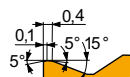

R je geometrie pro polohrubovací až hrubovací operace, plynulý až přerušovaný řez.

CNMG 120408E-R	T5315	0.8	120	0.40	4.0	-	-	-	80	0.40	4.0	-	-	-	-	-	-	30	0.15	1.0
	T9325	0.8	120	0.40	4.0	-	-	-	80	0.40	4.0	-	-	-	-	-	-	-	-	-

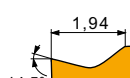

SF je pozitivní geometrie pro jemné dokončování, obrábění tenkostěnných dílů a plynulý řez.

CNMG 120404E-SF	H07	0.4	-	-	-	90	0.14	1.0	110	0.15	1.0	330	0.18	1.0	34	0.12	0.8	-	-	-
	T6310	0.4	140	0.15	1.0	100	0.14	1.0	110	0.15	1.0	330	0.18	1.0	38	0.12	0.8	26	0.15	1.0
CNMG 120408E-SF	H07	0.8	-	-	-	95	0.18	1.0	100	0.20	1.0	300	0.24	1.0	38	0.14	0.8	-	-	-
	T6310	0.8	130	0.20	1.0	100	0.18	1.0	100	0.20	1.0	300	0.24	1.0	45	0.14	0.8	30	0.15	1.0

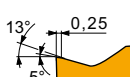

SM je pozitivní geometrie pro střední obrábění, plynulý až přerušovaný řez.

CNMG 120404E-SM	T6310	0.4	130	0.22	2.0	95	0.20	2.0	100	0.22	2.0	300	0.26	2.0	34	0.20	1.6	23	0.15	1.0
	T7325	0.4	130	0.22	2.0	95	0.20	2.0	-	-	-	-	-	41	0.20	1.6	-	-	-	
CNMG 120408E-SM	T6310	0.8	120	0.25	2.0	95	0.23	2.0	95	0.25	2.0	270	0.30	2.0	38	0.20	1.6	26	0.15	1.0
	T7325	0.8	120	0.25	2.0	95	0.23	2.0	-	-	-	-	-	45	0.20	1.6	-	-	-	

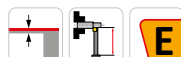
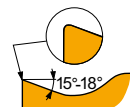

EL-SI je pozitivní geometrie v levostranném provedení pro jemné dokončování až polohrubovací operace a plynulý řez.

CNMG 120404EL-SI	T7325	0.4	130	0.20	1.7	100	0.18	1.7	-	-	-	-	-	45	0.18	1.4	-	-	-	
	T8330	0.4	130	0.20	1.7	100	0.18	1.7	-	-	-	300	0.24	1.7	34	0.18	1.4	-	-	-
	T8430	0.4	130	0.20	1.7	100	0.18	1.7	-	-	-	300	0.24	1.7	34	0.18	1.4	-	-	-
CNMG 120408EL-SI	T7325	0.8	120	0.35	1.7	90	0.32	1.7	-	-	-	-	-	45	0.25	1.4	-	-	-	
	T8330	0.8	120	0.35	1.7	90	0.32	1.7	-	-	-	220	0.42	1.7	34	0.25	1.4	-	-	-
	T8430	0.8	120	0.35	1.7	90	0.32	1.7	-	-	-	220	0.42	1.7	30	0.25	1.4	-	-	-



DCMT

	IC (mm)	D1 (mm)	L (mm)	S (mm)
11T3	9.525	4.40	11.60	3.97
1504	12.700	5.50	15.50	4.76

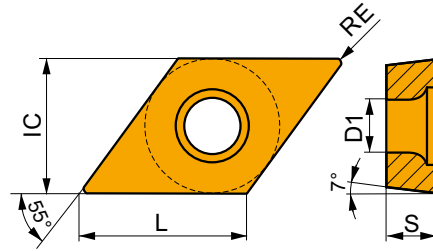

Startovní řezné podmínky, řezná rychlost (Vc), posuv (f) a hloubka řezu (Ap). Další výpočty naleznete v naší aplikaci Kalkulátor řezných podmínek.

Produkt	RE (mm)	P			M			K			N			S			H		
		vc (m/min)	f (mm/rev)	ap (mm)	vc (m/min)	f (mm/rev)	ap (mm)	vc (m/min)	f (mm/rev)	ap (mm)	vc (m/min)	f (mm/rev)	ap (mm)	vc (m/min)	f (mm/rev)	ap (mm)	vc (m/min)	f (mm/rev)	ap (mm)

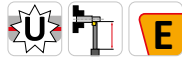
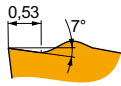

FF2 je pozitivní geometrie pro jemné a dokončovací operace, plynulý až mírně přerušovaný řez.

DCMT 11T308E-FF2	T7325	0.8	130	0.17	0.8	-	-	-	-	-	-	-	-	-	-	-	-	-
	T8330	0.8	130	0.17	0.8	-	-	-	105	0.17	0.8	-	-	-	-	-	-	-
	T8430	0.8	130	0.17	0.8	-	-	-	105	0.17	0.8	-	-	-	-	-	-	-

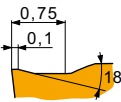

FM2 je geometrie pro dokončovací až střední operace, plynulý až přerušovaný řez.

DCMT 150408E-FM2	T9325	0.8	130	0.20	1.5	100	0.18	1.5	100	0.20	1.5	-	-	-	-	-	-
	T9335	0.8	130	0.20	1.5	95	0.18	1.5	-	-	-	-	-	-	-	-	-

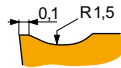

RF je geometrie pro polohrubovací až hrubovací operace, plynulý až přerušovaný řez.

DCMT 11T308E-RF	T5315	0.8	130	0.20	0.8	-	-	-	100	0.20	0.8	-	-	-	-	-	30	0.15	1.0
	T7335	0.8	130	0.20	0.8	100	0.18	0.8	-	-	-	-	-	-	-	-	-	-	



EPGX

PRAMET

	IC	D1	L	S
	(mm)	(mm)	(mm)	(mm)
0502	5.560	2.50	5.70	2.38

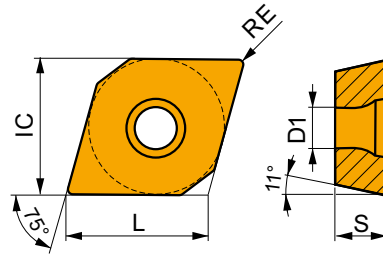

Startovní řezné podmínky, řezná rychlost (Vc), posuv (f) a hloubka řezu (Ap). Další výpočty naleznete v naší aplikaci Kalkulátor řezných podmínek.

Produkt	RE	P			M			K			N			S			H		
		vc	f	ap	vc	f	ap	vc	f	ap	vc	f	ap	vc	f	ap	vc	f	ap
	(mm)	(m/min)	(mm/rev)	(mm)	(m/min)	(mm/rev)	(mm)	(m/min)	(mm/rev)	(mm)	(m/min)	(mm/rev)	(mm)	(m/min)	(mm/rev)	(mm)	(m/min)	(mm/rev)	(mm)

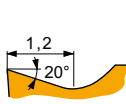

FL-JZ je pozitivní geometrie v levostranném provedení pro jemné dokončování a plynulý řez.

EPGX 050202FL-JZ	TT010	0.2	150	0.06	0.5	110	0.05	0.5	-	-	-	-	-	-	-	-	-	-	-
------------------	-------	-----	-----	------	-----	-----	------	-----	---	---	---	---	---	---	---	---	---	---	---

EPMT

PRAMET

	IC	D1	L	S
	(mm)	(mm)	(mm)	(mm)
0502	5.560	2.50	5.70	2.38

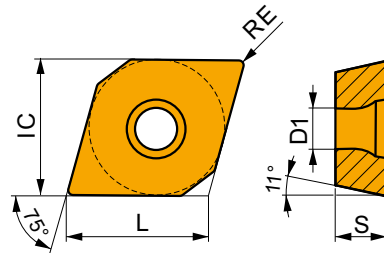

Startovní řezné podmínky, řezná rychlost (Vc), posuv (f) a hloubka řezu (Ap). Další výpočty naleznete v naší aplikaci Kalkulátor řezných podmínek.

Produkt	RE	P			M			K			N			S			H		
		vc	f	ap	vc	f	ap	vc	f	ap	vc	f	ap	vc	f	ap	vc	f	ap
	(mm)	(m/min)	(mm/rev)	(mm)	(m/min)	(mm/rev)	(mm)	(m/min)	(mm/rev)	(mm)	(m/min)	(mm/rev)	(mm)	(m/min)	(mm/rev)	(mm)	(m/min)	(mm/rev)	(mm)



NF2 je pozitivní geometrie pro jemné dokončovací až polohrubovací operace a plynulý řez.

EPMT 050202E-NF2	H07	0.2	-	-	-	80	0.09	0.8	115	0.10	0.8	360	0.12	0.8	30	0.07	0.6	-	-	-
	T7325	0.2	150	0.07	0.8	110	0.06	0.8	-	-	-	-	-	-	45	0.06	0.6	-	-	-
	T7335	0.2	150	0.07	0.8	110	0.06	0.8	-	-	-	-	-	-	45	0.06	0.6	-	-	-
	T9315	0.2	150	0.05	0.8	-	-	-	115	0.05	0.8	-	-	-	-	-	-	-	-	-
	T9325	0.2	150	0.07	0.8	110	0.06	0.8	115	0.07	0.8	-	-	-	45	0.06	0.6	-	-	-
	T9335	0.2	140	0.10	0.8	110	0.09	0.8	-	-	-	-	-	-	34	0.07	0.6	-	-	-
	TT010	0.2	150	0.05	0.5	110	0.05	0.5	-	-	-	-	-	-	-	-	-	-	-	-



TCGT

	IC (mm)	D1 (mm)	L (mm)	S (mm)
06T1	3.970	2.20	6.90	1.98
0902	5.560	2.50	9.60	2.38
1102-SF3	6.350	2.80	11.00	2.58
16T3	9.525	4.40	16.50	3.97
16T3-SF3	9.525	4.40	16.50	4.22

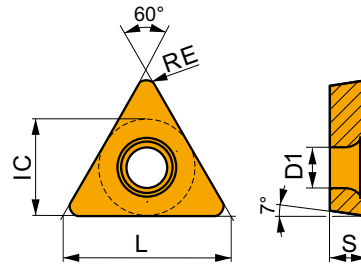

Startovní řezné podmínky, řezná rychlost (Vc), posuv (f) a hloubka řezu (Ap). Další výpočty naleznete v naší aplikaci Kalkulátor řezných podmínek.

Produkt	RE (mm)	P			M			K			N			S			H		
		vc (m/min)	f (mm/rev)	ap (mm)	vc (m/min)	f (mm/rev)	ap (mm)	vc (m/min)	f (mm/rev)	ap (mm)	vc (m/min)	f (mm/rev)	ap (mm)	vc (m/min)	f (mm/rev)	ap (mm)	vc (m/min)	f (mm/rev)	ap (mm)



AL je vysoce pozitivní geometrie pro jemné dokončování až hrubování, plynulý až mírně přerušovaný řez.

TCGT 090202F-AL	HF7	0.2	-	-	-	-	-	-	-	360	0.12	1.0	-	-	-	-	-	-
	T0315	0.2	-	-	-	-	-	-	-	360	0.12	1.0	-	-	-	-	-	-
TCGT 090204F-AL	HF7	0.4	-	-	-	-	-	-	-	300	0.24	1.0	-	-	-	-	-	-
	T0315	0.4	-	-	-	-	-	-	-	300	0.24	1.0	-	-	-	-	-	-
TCGT 16T304F-AL	HF7	0.4	-	-	-	-	-	-	-	300	0.24	2.4	-	-	-	-	-	-
	T0315	0.4	-	-	-	-	-	-	-	300	0.24	2.4	-	-	-	-	-	-
TCGT 16T308F-AL	HF7	0.8	-	-	-	-	-	-	-	200	0.48	2.4	-	-	-	-	-	-
	T0315	0.8	-	-	-	-	-	-	-	200	0.48	2.4	-	-	-	-	-	-

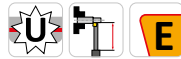
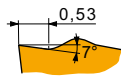

FF2 je pozitivní geometrie pro jemné a dokončovací operace, plynulý až mírně přerušovaný řez.

TCGT 06T102E-FF2	T8330	0.2	150	0.05	0.8	-	-	-	115	0.05	0.8	-	-	-	-	-	-	-
	T8430	0.2	150	0.05	0.8	-	-	-	115	0.05	0.8	-	-	-	-	-	-	-
	TT010	0.2	150	0.05	0.5	-	-	-	-	-	-	-	-	-	-	-	-	-
TCGT 090202E-FF2	TT010	0.2	150	0.05	0.5	-	-	-	-	-	-	-	-	-	-	-	-	-

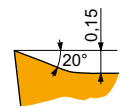

SF3 je vysoce pozitivní geometrie pro jemné a dokončovací operace a plynulý řez.

TCGT 110204E-SF3	H07	0.4	-	-	-	80	0.09	0.8	115	0.10	0.8	360	0.12	0.8	30	0.07	0.6	-	-	-
	T6310	0.4	140	0.10	0.8	110	0.09	0.8	115	0.10	0.8	360	0.12	0.8	34	0.07	0.6	23	0.15	1.0
TCGT 16T308E-SF3	H07	0.8	-	-	-	90	0.09	1.2	115	0.10	1.2	360	0.12	1.2	34	0.08	1.0	-	-	-
	T6310	0.8	140	0.10	1.2	110	0.09	1.2	115	0.10	1.2	360	0.12	1.2	38	0.08	1.0	26	0.15	1.0



TCMT

	IC	D1	L	S
	(mm)	(mm)	(mm)	(mm)
06T1	3.970	2.20	6.90	1.98
0902	5.560	2.50	9.60	2.38
16T3	9.525	4.40	16.50	3.97

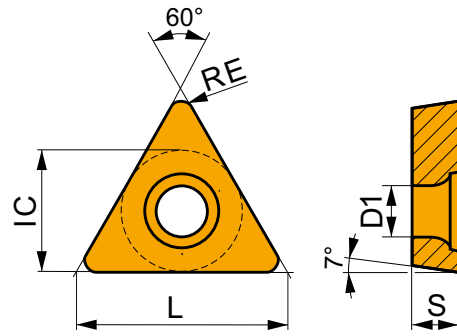

Startovní rezní podmínky, rezná rychlost (Vc), posuv (f) a hloubka řezu (Ap). Další výpočty naleznete v naší aplikaci Kalkulátor rezních podmínek.

Produkt	RE	P			M			K			N			S			H		
		vc	f	ap	vc	f	ap	vc	f	ap	vc	f	ap	vc	f	ap	vc	f	ap
	(mm)	(m/min)	(mm/rev)	(mm)	(m/min)	(mm/rev)	(mm)	(m/min)	(mm/rev)	(mm)	(m/min)	(mm/rev)	(mm)	(m/min)	(mm/rev)	(mm)	(m/min)	(mm/rev)	(mm)

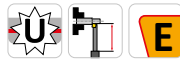
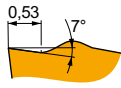

FF2 je pozitivní geometrie pro jemné a dokončovací operace, plynulý až mírně přerušovaný řez.

TCMT 06T102E-FF2	T8330	0.2	█	150	0.05	0.8	█	–	–	–	█	115	0.05	0.8	–	–	–	–	–	–
	T8430	0.2	█	150	0.05	0.8	█	–	–	–	█	115	0.05	0.8	–	–	–	–	–	–
	T9315	0.2	█	150	0.05	0.8	█	–	–	–	█	115	0.05	0.8	–	–	–	–	–	–
TCMT 06T104E-FF2	T8330	0.4	█	140	0.12	0.8	█	–	–	–	█	110	0.12	0.8	–	–	–	–	–	–
	T8430	0.4	█	140	0.12	0.8	█	–	–	–	█	110	0.12	0.8	–	–	–	–	–	–
	T9325	0.4	█	140	0.12	0.8	█	–	–	–	█	110	0.12	0.8	–	–	–	–	–	–
TCMT 090204E-FF2	T8330	0.4	█	140	0.12	1.0	█	–	–	–	█	110	0.12	1.0	–	–	–	–	–	–
	T8430	0.4	█	140	0.12	1.0	█	–	–	–	█	110	0.12	1.0	–	–	–	–	–	–
	T9325	0.4	█	140	0.12	1.0	█	–	–	–	█	110	0.12	1.0	–	–	–	–	–	–
TCMT 16T304E-FF2	T8330	0.4	█	140	0.12	0.8	█	–	–	–	█	110	0.12	0.8	–	–	–	–	–	–
	T8430	0.4	█	140	0.12	0.8	█	–	–	–	█	110	0.12	0.8	–	–	–	–	–	–
	T9325	0.4	█	140	0.12	0.8	█	–	–	–	█	110	0.12	0.8	–	–	–	–	–	–
TCMT 16T308E-FF2	TT010	0.4	█	150	0.06	0.5	█	–	–	–	–	–	–	–	–	–	–	–	–	–
	T8330	0.8	█	130	0.17	0.8	█	–	–	–	█	105	0.17	0.8	–	–	–	–	–	–
	T8430	0.8	█	130	0.17	0.8	█	–	–	–	█	105	0.17	0.8	–	–	–	–	–	–
T9325	0.8	█	130	0.17	0.8	█	–	–	–	█	105	0.17	0.8	–	–	–	–	–	–	–

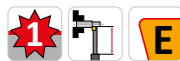

FM je geometrie pro dokončovací až polohrubovací operace, plynulý až mírně přerušovaný řez.

TCMT 16T304E-FM	T7325	0.4	█	130	0.19	1.7	█	100	0.17	1.7	█	–	–	–	█	360	0.14	1.7	–	–	–
	T8330	0.4	█	140	0.12	1.7	█	90	0.11	1.7	█	110	0.12	1.7	█	360	0.14	1.7	–	–	–
	T8430	0.4	█	140	0.12	1.7	█	90	0.11	1.7	█	110	0.12	1.7	█	360	0.14	1.7	–	–	–

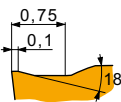

FM2 je geometrie pro dokončovací až střední operace, plynulý až přerušovaný řez.

TCMT 16T308E-FM2	T8330	0.8	█	130	0.20	1.0	█	85	0.18	1.0	█	100	0.20	1.0	–	–	–	–	–	–
	T8430	0.8	█	130	0.20	1.0	█	85	0.18	1.0	█	100	0.20	1.0	–	–	–	–	–	–
	T9325	0.8	█	130	0.20	1.0	█	100	0.18	1.0	█	100	0.20	1.0	–	–	–	–	–	–

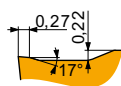

RM je geometrie pro polohrubovací až hrubovací operace, plynulý až přerušovaný řez.

TCMT 16T308E-RM	T5315	0.8	█	120	0.27	1.9	█	–	–	–	█	95	0.27	1.9	–	–	–	█	35	0.15	1.0
	T8330	0.8	█	120	0.27	1.9	█	85	0.24	1.9	█	95	0.27	1.9	–	–	–	█	26	0.19	1.5
	T8430	0.8	█	120	0.27	1.9	█	85	0.24	1.9	█	95	0.27	1.9	–	–	–	█	23	0.19	1.5



Startovní řezné podmínky, řezná rychlost (Vc), posuv (f) a hloubka řezu (Ap). Další výpočty naleznete v naší aplikaci Kalkulátor řezných podmínek.

Produkt	RE (mm)	P			M			K			N			S			H		
		vc (m/min)	f (mm/rev)	ap (mm)	vc (m/min)	f (mm/rev)	ap (mm)	vc (m/min)	f (mm/rev)	ap (mm)	vc (m/min)	f (mm/rev)	ap (mm)	vc (m/min)	f (mm/rev)	ap (mm)	vc (m/min)	f (mm/rev)	ap (mm)

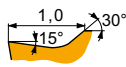
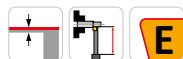

UR je geometrie pro jemné a dokončovací operace a plynulý až mírně přerušovaný řez.

TCMT 16T304E-UR	T8330	0.4	135	0.12	0.8	80	0.11	0.8	110	0.12	0.8	-	-	-	-	-	-	-
	T8430	0.4	140	0.12	0.8	85	0.11	0.8	110	0.12	0.8	-	-	-	-	-	-	-
	T9325	0.4	130	0.18	0.8	100	0.16	0.8	105	0.18	0.8	-	-	-	-	-	-	-
TCMT 16T308E-UR	TT310	0.4	140	0.12	0.8	110	0.11	0.8	-	-	-	-	-	-	-	-	-	-
	T8330	0.8	130	0.17	0.8	90	0.15	0.8	105	0.17	0.8	-	-	-	-	-	-	-
	T8430	0.8	130	0.17	0.8	90	0.15	0.8	105	0.17	0.8	-	-	-	-	-	-	-
	T9325	0.8	130	0.17	0.8	100	0.15	0.8	105	0.17	0.8	-	-	-	-	-	-	-

TCMW



	IC (mm)	D1 (mm)	L (mm)	S (mm)
16T3	9.525	4.40	16.50	3.97

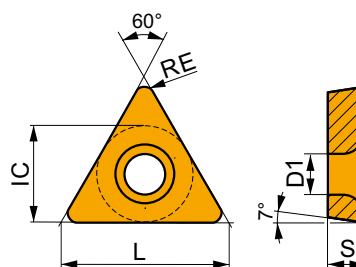

Startovní řezné podmínky, řezná rychlost (Vc), posuv (f) a hloubka řezu (Ap). Další výpočty naleznete v naší aplikaci Kalkulátor řezných podmínek.

Produkt	RE (mm)	P			M			K			N			S			H		
		vc (m/min)	f (mm/rev)	ap (mm)	vc (m/min)	f (mm/rev)	ap (mm)	vc (m/min)	f (mm/rev)	ap (mm)	vc (m/min)	f (mm/rev)	ap (mm)	vc (m/min)	f (mm/rev)	ap (mm)	vc (m/min)	f (mm/rev)	ap (mm)

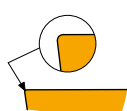

Pro jemné dokončovací až polohrubovací operace, plynulý až mírně přerušovaný řez.

TCMW 16T304	T5305	0.4	-	-	-	-	-	-	115	0.10	1.5	-	-	-	-	-	-	30	0.15	1.0
	T5315	0.4	-	-	-	-	-	-	115	0.10	1.5	-	-	-	-	-	-	26	0.15	1.0
	T6310	0.4	-	-	-	-	-	-	85	0.10	1.5	-	-	-	-	-	-	15	0.15	1.0
TCMW 16T308	T5305	0.8	-	-	-	-	-	-	105	0.18	1.5	-	-	-	-	-	-	30	0.15	1.0
	T5315	0.8	-	-	-	-	-	-	105	0.18	1.5	-	-	-	-	-	-	26	0.15	1.0
	T6310	0.8	-	-	-	-	-	-	85	0.18	1.5	-	-	-	-	-	-	15	0.15	1.0



UPÍNAČE - VYVRTÁVÁNÍ



UPÍNAČE VYVRTÁVÁNÍ - OZNAČENÍ

1	2	3	4	5
AS 3	30	022	100	R

1		2	3	4		5	
Typ kuželu		Velikost kuželu	Velikost hlavy	Délka PM		Varianta	
AS 3	DIN 69871	30	022	055	55 mm	R	S vnitřním chlazením
BT 3	MAS BT	40	027	100	100 mm		
HSK	HSK	63A	032				
OTT 3	DIN 2080	50	042				
3	MORSE	05	054				
B	WELDON	25	068				
P	EXTENSION		085				
R	REDUCTION		100				
ADT	ADAPTOR		200				
			300				
			400				
			500				



69871-BS

PRAMET



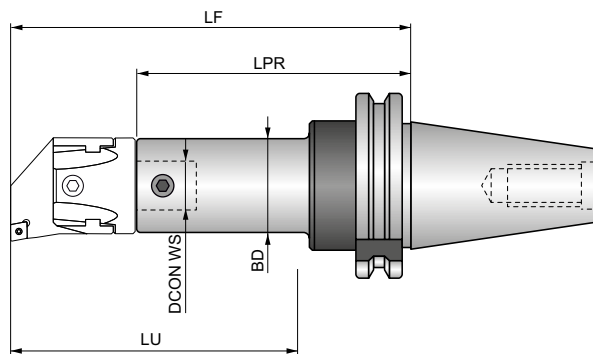

Upínač vyvrtávacích hlav s kuzelem dle DIN 69871

Tuhý upínač s kuzelem dle DIN 69871 SK30, 40 a 50, určený pro vyvrtávací hlavy. Dostupné jsou různé délkové varianty. Může být použit v kombinaci s prodloužením EXT-BS, redukcí RED-BS nebo spojkovým prodloužením LA-BS. Možnost vnitřního chlazení. Pro aplikace vyžadující přesnost a opakovatelnost procesu.



Produkt		CZC MS	BD	DCON WS	LF	LPR	LU			
			(mm)	(mm)	(mm)	(mm)	(mm)			
AS 330 022 100 R	30	22	22.00	12.00	138.00	104	100.00	✓	US 0608	0.72
AS 330 027 055 R	30	27	27.00	15.00	90.00	48	55.00	✓	US 0609	0.56
AS 330 027 100 R	30	27	27.00	15.00	138.00	96	100.00	✓	US 0609	0.68
AS 330 032 060 R	30	32	32.00	20.00	96.00	51	60.00	✓	US 0810	0.51
AS 330 032 100 R	30	32	32.00	20.00	138.00	93	100.00	✓	US 0810	0.74
AS 340 022 080 R	40	22	22.00	12.00	118.00	84	80.00	✓	US 0608	1.14
AS 340 022 100 R	40	22	22.00	12.00	138.00	104	100.00	✓	US 0608	1.24
AS 340 027 055 R	40	27	27.00	15.00	90.00	48	55.00	✓	US 0609	1.05
AS 340 027 100 R	40	27	27.00	15.00	138.00	96	100.00	✓	US 0609	1.30
AS 340 027 130 R	40	27	27.00	15.00	168.00	126	130.00	✓	US 0609	1.43
AS 340 032 060 R	40	32	32.00	20.00	96.00	51	60.00	✓	US 0810	1.10
AS 340 032 100 R	40	32	32.00	20.00	138.00	93	100.00	✓	US 0810	1.35
AS 340 032 130 R	40	32	32.00	20.00	168.00	123	130.00	✓	US 0810	1.52
AS 340 042 075 R	40	42	42.00	24.00	112.00	56	75.00	✓	US 1014	1.16
AS 340 042 160 R	40	42	42.00	24.00	182.00	126	160.00	✓	US 1014	1.90
AS 340 042 200 R	40	42	42.00	24.00	222.00	166	200.00	✓	US 1014	2.37
AS 340 054 120 R	40	54	54.00	28.00	142.00	76	120.00	✓	US 1219	1.58
AS 340 054 160 R	40	54	54.00	28.00	182.00	116	160.00	✓	US 1219	2.28
AS 340 054 200 R	40	54	54.00	28.00	222.00	156	200.00	✓	US 1219	2.93
AS 340 068 160 R	40	68	68.00	36.00	183.00	97	160.00	✓	US 1625	2.36
AS 340 068 200 R	40	68	68.00	36.00	223.00	137	200.00	✓	US 1625	3.50
AS 340 085 200 R	40	85	85.00	50.00	224.00	124	200.00	✓	US 1630	3.96
AS 340 100 200 R	40	100, 200	100.00	60.00	224.00	124	200.00	✓	US 2032	5.21
AS 350 022 080 R	50	22	22.00	12.00	118.00	84	80.00	✓	US 0608	3.43
AS 350 022 100 R	50	22	22.00	12.00	138.00	104	100.00	✓	US 0608	3.40
AS 350 027 055 R	50	27	27.00	15.00	90.00	48	55.00	✓	US 0609	3.30
AS 350 027 100 R	50	27	27.00	15.00	138.00	96	100.00	✓	US 0609	3.48
AS 350 027 130 R	50	27	27.00	15.00	168.00	126	130.00	✓	US 0609	3.48
AS 350 032 060 R	50	32	32.00	20.00	96.00	51	60.00	✓	US 0810	2.98
AS 350 032 130 R	50	32	32.00	20.00	168.00	123	130.00	✓	US 0810	3.71
AS 350 032 160 R	50	32	32.00	20.00	198.00	153	160.00	✓	US 0810	3.95
AS 350 042 075 R	50	42	42.00	24.00	112.00	56	75.00	✓	US 1014	3.32
AS 350 042 160 R	50	42	42.00	24.00	198.00	142	160.00	✓	US 1014	4.26
AS 350 042 200 R	50	42	42.00	24.00	238.00	182	200.00	✓	US 1014	4.74



Produkt		CZC MS	BD	DCON WS	LF	LPR	LU			
			(mm)	(mm)	(mm)	(mm)	(mm)			
AS 350 054 090 R	50	54	54.00	28.00	128.00	62	90.00	✓	US 1219	3.39
AS 350 054 160 R	50	54	54.00	28.00	198.00	132	160.00	✓	US 1219	4.74
AS 350 054 200 R	50	54	54.00	28.00	238.00	172	200.00	✓	US 1219	5.48
AS 350 068 115 R	50	68	68.00	36.00	151.00	65	115.00	✓	US 1625	3.66
AS 350 068 200 R	50	68	68.00	36.00	223.00	137	200.00	✓	US 1625	5.81
AS 350 068 260 R	50	68	68.00	36.00	283.00	197	260.00	✓	US 1625	7.48
AS 350 085 200 R	50	85	85.00	50.00	224.00	124	200.00	✓	US 1630	6.21
AS 350 085 260 R	50	85	85.00	50.00	284.00	184	260.00	✓	US 1630	8.91
AS 350 085 320 R	50	85	85.00	50.00	344.00	244	320.00	✓	US 1630	11.50
AS 350 100 190 R	50	100, 200	100.00	60.00	214.00	114	190.00	✓	US 2032	6.52
AS 350 100 260 R	50	100, 200	100.00	60.00	284.00	184	260.00	✓	US 2032	10.85
AS 350 100 320 R	50	100, 200	100.00	60.00	344.00	244	320.00	✓	US 2032	14.47
AS 550 160	50	300, 400, 500	100.00	60.00	160.00	70	125.00	–	US 1240	5.55



BT-BS





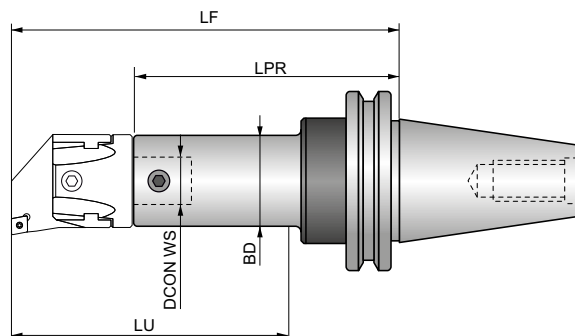

Upínač vyvrtávacích hlav s kuzelem dle MAS 403-BT

Tuhý upínač s kuzelem dle MAS 403-BT BT30, 40 a 50, určený pro vyvrtávací hlavy. Dostupné jsou různé délkové varianty. Může být použit v kombinaci s prodloužením EXT-BS, redukcí RED-BS nebo spojkovým prodloužením LA-BS. Možnost vnitřního chlazení. Pro aplikace vyžadující přesnost a opakovatelnost procesu.



Produkt		CZC MS	BD	DCON WS	LF	LPR	LU			
			(mm)	(mm)	(mm)	(mm)	(mm)			
BT 330 022 100 R	30	22	22.00	12.00	125.00	91	100.00	✓	US 0608	0.56
BT 330 027 055 R	30	27	27.00	15.00	77.00	35	55.00	✓	US 0609	0.41
BT 330 027 100 R	30	27	27.00	15.00	125.00	83	100.00	✓	US 0609	0.69
BT 330 032 060 R	30	32	32.00	20.00	83.00	38	60.00	✓	US 0810	0.47
BT 330 032 100 R	30	32	32.00	20.00	125.00	80	100.00	✓	US 0810	0.70
BT 330 042 075 R	30	42	42.00	24.00	100.00	44	75.00	✓	US 1014	0.56
BT 340 022 050 R	40	22	22.00	12.00	80.00	46	50.00	✓	US 0608	1.02
BT 340 022 080 R	40	22	22.00	12.00	110.00	76	80.00	✓	US 0608	1.16
BT 340 022 100 R	40	22	22.00	12.00	130.00	96	100.00	✓	US 0608	1.14
BT 340 027 055 R	40	27	27.00	15.00	82.00	40	55.00	✓	US 0609	1.06
BT 340 027 100 R	40	27	27.00	15.00	130.00	88	100.00	✓	US 0609	1.26
BT 340 027 130 R	40	27	27.00	15.00	160.00	118	130.00	✓	US 0609	1.39
BT 340 032 060 R	40	32	32.00	20.00	88.00	43	60.00	✓	US 0810	1.00
BT 340 032 100 R	40	32	32.00	20.00	130.00	85	100.00	✓	US 0810	1.31
BT 340 032 130 R	40	32	32.00	20.00	160.00	115	130.00	✓	US 0810	1.50
BT 340 042 075 R	40	42	42.00	24.00	104.00	48	75.00	✓	US 1014	1.14
BT 340 042 160 R	40	42	42.00	24.00	190.00	134	160.00	✓	US 1014	2.05
BT 340 042 200 R	40	42	42.00	24.00	230.00	174	200.00	✓	US 1014	2.39
BT 340 054 090 R	40	54	54.00	28.00	120.00	54	90.00	✓	US 1219	1.13
BT 340 054 160 R	40	54	54.00	28.00	190.00	124	160.00	✓	US 1219	2.55
BT 340 054 200 R	40	54	54.00	28.00	230.00	164	200.00	✓	US 1219	3.10
BT 340 068 160 R	40	68	68.00	36.00	181.00	95	160.00	✓	US 1625	2.46
BT 340 068 200 R	40	68	68.00	36.00	221.00	135	200.00	✓	US 1625	3.64
BT 340 085 200 R	40	85	85.00	50.00	220.00	120	200.00	✓	US 1630	4.04
BT 340 100 200 R	40	100	100.00	60.00	220.00	120	200.00	✓	US 2032	4.95
BT 350 022 080 R	50	22	22.00	12.00	121.00	87	80.00	✓	US 0608	3.95
BT 350 022 100 R	50	22	22.00	12.00	141.00	107	100.00	✓	US 0608	3.50
BT 350 027 055 R	50	27	27.00	15.00	93.00	51	55.00	✓	US 0609	3.68
BT 350 027 100 R	50	27	27.00	15.00	141.00	99	100.00	✓	US 0609	4.00
BT 350 027 130 R	50	27	27.00	15.00	171.00	129	130.00	✓	US 0609	4.14
BT 350 032 060 R	50	32	32.00	20.00	99.00	54	60.00	✓	US 0810	3.67
BT 350 032 130 R	50	32	32.00	20.00	171.00	126	130.00	✓	US 0810	4.24
BT 350 032 160 R	50	32	32.00	20.00	201.00	156	160.00	✓	US 0810	4.56
BT 350 042 075 R	50	42	42.00	24.00	115.00	59	75.00	✓	US 1014	3.84



Produkt		CZC MS	BD	DCON WS	LF	LPR	LU			
			(mm)	(mm)	(mm)	(mm)	(mm)			
BT 350 042 160 R	50	42	42.00	24.00	201.00	145	160.00	✓	US 1014	4.89
BT 350 042 200 R	50	42	42.00	24.00	241.00	185	200.00	✓	US 1014	5.25
BT 350 054 090 R	50	54	54.00	28.00	131.00	65	90.00	✓	US 1219	3.90
BT 350 054 160 R	50	54	54.00	28.00	201.00	135	160.00	✓	US 1219	5.39
BT 350 054 200 R	50	54	54.00	28.00	241.00	175	200.00	✓	US 1219	5.98
BT 350 068 115 R	50	68	68.00	36.00	154.00	68	115.00	✓	US 1625	4.09
BT 350 068 200 R	50	68	68.00	36.00	242.00	156	200.00	✓	US 1625	6.66
BT 350 068 260 R	50	68	68.00	36.00	302.00	216	260.00	✓	US 1625	8.18
BT 350 085 200 R	50	85	85.00	50.00	242.00	142	200.00	✓	US 1630	7.40
BT 350 085 260 R	50	85	85.00	50.00	302.00	202	260.00	✓	US 1630	9.89
BT 350 085 320 R	50	85	85.00	50.00	362.00	262	320.00	✓	US 1630	12.76
BT 350 100 170 R	50	100, 200	100.00	60.00	195.00	95	170.00	✓	US 2032	5.71
BT 350 100 260 R	50	100, 200	100.00	60.00	302.00	202	260.00	✓	US 2032	12.34
BT 350 100 320 R	50	100, 200	100.00	60.00	362.00	262	320.00	✓	US 2032	14.50
BT 550 160	50	300, 400, 500	100.00	60.00	160.00	70	125.00	–	US 1240	6.05



HSK-BS

PRAMET



Upínač vyvrtávacích hlav s kuzelem HSK-A dle DIN 69893

Tuhý upínač s kuzelem HSK-A dle DIN 69893 HSK50A, 63A a 100A, určený pro vyvrtávací hlavy. Dostupné jsou různé délkové varianty. Může být použit v kombinaci s prodloužením EXT-BS, redukcí RED-BS nebo spojkovým prodloužením LA-BS. Možnost vnitřního chlazení. Pro aplikace vyžadující přesnost a opakovatelnost procesu.

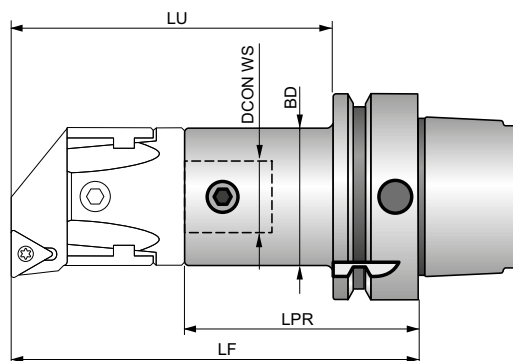

Produkt		CZC MS	BD	DCON WS	LF	LPR	LU			
HSK 050A 022 055	50	22	22.00	12.00	81.00	47	55.00	—	US 0608	0.49
HSK 050A 027 065	50	27	27.00	15.00	91.00	49	65.00	—	US 0609	0.49
HSK 050A 032 075	50	32	32.00	20.00	101.00	56	75.00	—	US 0810	0.66
HSK 050A 042 090	50	42	42.00	24.00	116.00	60	90.00	—	US 1014	0.71
HSK 063A 022 055	63	22	22.00	12.00	81.00	47	55.00	—	US 0608	0.07
HSK 063A 027 065	63	27	27.00	15.00	91.00	49	65.00	—	US 0609	0.76
HSK 063A 032 075	63	32	32.00	20.00	101.00	56	75.00	—	US 0810	0.82
HSK 063A 042 090	63	42	42.00	24.00	116.00	60	90.00	—	US 1014	0.96
HSK 063A 054 110	63	54	54.00	28.00	136.00	70	110.00	—	US 1219	1.26
HSK 063A 068 145	63	68	68.00	36.00	171.00	85	145.00	—	US 1625	1.81
HSK 100A 022 055	100	22	22.00	12.00	89.00	55	55.00	—	US 0608	2.28
HSK 100A 027 065	100	27	27.00	15.00	99.00	57	65.00	—	US 0609	2.34
HSK 100A 032 075	100	32	32.00	20.00	104.00	59	75.00	—	US 0810	2.73
HSK 100A 042 090	100	42	42.00	24.00	119.00	63	90.00	—	US 1014	2.45
HSK 100A 054 110	100	54	54.00	28.00	139.00	73	110.00	—	US 1219	2.79
HSK 100A 068 145	100	68	68.00	36.00	174.00	88	145.00	—	US 1625	3.52
HSK 100A 085 165	100	85	85.00	50.00	194.00	94	165.00	—	US 1630	4.15
HSK 100A 100 185	100	100, 200	100.00	60.00	214.00	114	185.00	—	US 2032	5.63
HSK 550 160	100	300, 400, 500	100.00	60.00	170.00	80	140.00	—	US 1240	5.24



2080-BS

PRAMET





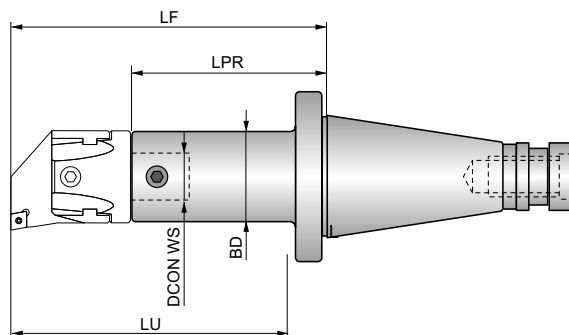

Upínač vyvrtávacích hlav s kuželem dle DIN 2080

Tuhý upínač s kuželem dle DIN 2080 SK40 a 50, určený pro vyvrtávací hlavy. Dostupné jsou různé délkové varianty. Může být použit v kombinaci s prodloužením EXT-BS, redukcí RED-BS nebo spojkovým prodloužením LA-BS. Možnost vnitřního chlazení. Pro aplikace vyžadující přesnost a opakovatelnost procesu.



Produkt		CZC MS	BD	DCON WS	LF	LPR	LU			
OTT 340 022 080 R	40	22	22.00	12.00	95.00	61	80.00	✓	US 0608	0.88
OTT 340 022 100 R	40	22	22.00	12.00	115.00	81	100.00	✓	US 0608	0.94
OTT 340 027 055 R	40	27	27.00	15.00	67.00	25	55.00	✓	US 0609	0.86
OTT 340 027 100 R	40	27	27.00	15.00	115.00	73	100.00	✓	US 0609	1.00
OTT 340 027 130 R	40	27	27.00	15.00	145.00	103	130.00	✓	US 0609	1.12
OTT 340 032 060 R	40	32	32.00	20.00	73.00	28	60.00	✓	US 0810	0.90
OTT 340 032 100 R	40	32	32.00	20.00	115.00	70	100.00	✓	US 0810	1.10
OTT 340 032 130 R	40	32	32.00	20.00	145.00	100	130.00	✓	US 0810	1.22
OTT 340 042 075 R	40	42	42.00	24.00	89.00	33	75.00	✓	US 1014	0.89
OTT 340 042 160 R	40	42	42.00	24.00	175.00	119	160.00	✓	US 1014	1.73
OTT 340 042 200 R	40	42	42.00	24.00	215.00	159	200.00	✓	US 1014	2.30
OTT 340 054 090 R	40	54	54.00	28.00	105.00	39	90.00	✓	US 1219	1.08
OTT 340 054 160 R	40	54	54.00	28.00	175.00	109	160.00	✓	US 1219	2.23
OTT 340 054 200 R	40	54	54.00	28.00	215.00	149	200.00	✓	US 1219	3.06
OTT 340 068 160 R	40	68	68.00	36.00	175.00	90	160.00	✓	US 1625	2.40
OTT 340 068 200 R	40	68	68.00	36.00	216.00	130	200.00	✓	US 1625	3.73
OTT 340 085 200 R	40	85	85.00	50.00	211.00	111	200.00	✓	US 1630	4.03
OTT 340 100 200 R	40	100, 200	100.00	60.00	211.00	111	200.00	✓	US 2032	5.05
OTT 350 022 080 R	50	22	22.00	12.00	99.00	65	80.00	✓	US 0608	2.98
OTT 350 022 100 R	50	22	22.00	12.00	119.00	85	100.00	✓	US 0608	2.97
OTT 350 027 055 R	50	27	27.00	15.00	71.00	29	55.00	✓	US 0609	2.93
OTT 350 027 100 R	50	27	27.00	15.00	119.00	77	100.00	✓	US 0609	3.01
OTT 350 027 130 R	50	27	27.00	15.00	149.00	107	130.00	✓	US 0609	3.10
OTT 350 032 060 R	50	32	32.00	20.00	77.00	32	60.00	✓	US 0810	2.81
OTT 350 032 130 R	50	32	32.00	20.00	149.00	104	130.00	✓	US 0810	3.24
OTT 350 032 160 R	50	32	32.00	20.00	179.00	134	160.00	✓	US 0810	3.26
OTT 350 042 075 R	50	42	42.00	24.00	93.00	37	75.00	✓	US 1014	2.74
OTT 350 042 160 R	50	42	42.00	24.00	179.00	123	160.00	✓	US 1014	3.64
OTT 350 042 200 R	50	42	42.00	24.00	219.00	163	200.00	✓	US 1014	4.05
OTT 350 054 090 R	50	54	54.00	28.00	109.00	43	90.00	✓	US 1219	3.02
OTT 350 054 160 R	50	54	54.00	28.00	179.00	113	160.00	✓	US 1219	4.15
OTT 350 054 200 R	50	54	54.00	28.00	219.00	153	200.00	✓	US 1219	5.08
OTT 350 068 115 R	50	68	68.00	36.00	132.00	46	115.00	✓	US 1625	3.20
OTT 350 068 200 R	50	68	68.00	36.00	220.00	134	200.00	✓	US 1625	5.54



Produkt		CZC MS	BD	DCON WS	LF	LPR	LU			
			(mm)	(mm)	(mm)	(mm)	(mm)			
OTT 350 068 260 R	50	68	68.00	36.00	280.00	194	260.00	✓	US 1625	7.22
OTT 350 085 200 R	50	85	85.00	50.00	221.00	121	200.00	✓	US 1630	6.21
OTT 350 085 260 R	50	85	85.00	50.00	281.00	181	260.00	✓	US 1630	9.07
OTT 350 085 320 R	50	85	85.00	50.00	341.00	241	320.00	✓	US 1630	11.84
OTT 350 100 170 R	50	100, 200	100.00	60.00	193.00	93	170.00	✓	US 2032	5.60
OTT 350 100 260 R	50	100, 200	100.00	60.00	281.00	181	260.00	✓	US 2032	10.78
OTT 350 100 320 R	50	100, 200	100.00	60.00	341.00	241	320.00	✓	US 2032	15.10
OTT 550 160	50	300, 400, 500	100.00	60.00	160.00	70	125.00	–	US 1240	5.90



MOR-BS



Upínač vrtávacích hlav se stopkou Morse

Tuhý upínač se stopkou Morse 5, určený pro vrtávací hlavy. Dostupné jsou různé délkové varianty. Může být použit v kombinaci s prodloužením EXT-BS, redukcí RED-BS nebo spojovým prodloužením LA-BS. Bez možnosti vnitřního chlazení. Pro aplikace vyžadující přesnost a opakovatelnost procesu.

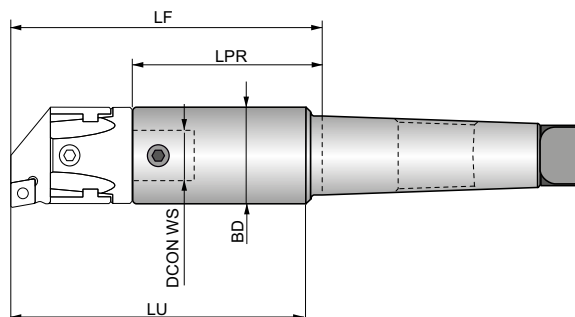

Produkt	CCTMS	CZC MS	BD	DCON WS	LF	LPR	LU			
305 022 100	5	22	22.00	12.00	112.00	78	100.00	–	US 0608	1.64
305 022 130	5	22	22.00	12.00	142.00	108	130.00	–	US 0608	1.76
305 027 055	5	27	27.00	15.00	65.00	23	55.00	–	US 0609	1.58
305 027 100	5	27	27.00	15.00	113.00	71	100.00	–	US 0609	1.69
305 027 130	5	27	27.00	15.00	143.00	101	130.00	–	US 0609	1.84
305 032 060	5	32	32.00	20.00	70.00	25	60.00	–	US 0810	1.54
305 032 130	5	32	32.00	20.00	143.00	98	130.00	–	US 0810	1.95
305 032 160	5	32	32.00	20.00	173.00	128	160.00	–	US 0810	2.13
305 042 075	5	42	42.00	24.00	83.00	27	75.00	–	US 1014	1.50
305 042 130	5	42	42.00	24.00	188.00	86	130.00	–	US 1014	2.18
305 042 160	5	42	42.00	24.00	218.00	116	160.00	–	US 1014	2.51
305 054 160	5	54	54.00	28.00	172.00	106	160.00	–	US 1219	3.00
305 054 200	5	54	54.00	28.00	212.00	146	200.00	–	US 1219	3.63
305 068 140	5	68	68.00	36.00	146.00	60	140.00	–	US 1625	2.53
305 068 200	5	68	68.00	36.00	212.00	126	200.00	–	US 1625	4.47
305 068 260	5	68	68.00	36.00	272.00	186	260.00	–	US 1625	6.20
305 085 200	5	85	85.00	50.00	216.00	116	200.00	–	US 1630	5.40
305 085 260	5	85	85.00	50.00	276.00	176	260.00	–	US 1630	8.45
305 085 320	5	85	85.00	50.00	336.00	236	320.00	–	US 1630	0.01
305 100 260	5	100, 200	100.00	60.00	276.00	176	260.00	–	US 2032	7.95
305 100 320	5	100, 200	100.00	60.00	336.00	236	320.00	–	US 2032	11.39
505 160	5	300, 400, 500	100.00	60.00	146.00	56	140.00	–	US 2032	4.70



WEL-BS

PRAMET



Upínač vyvrtávacích hlav se stopkou Weldon

Tuhý upínač se stopkou Weldon W20, W25, W32 a W40, určený pro vyvrtávací hlavy. Dostupné jsou různé délkové varianty. Může být použit v kombinaci s prodloužením EXT-BS a redukcí RED-BS. Bez možnosti vnitřního chlazení. Pro aplikace vyžadující přesnost a opakovatelnost procesu.

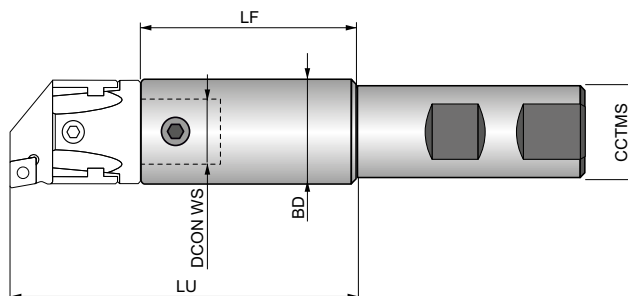

Produkt	CCTMS	CZC MS	BD	DCON WS	LU			
			(mm)	(mm)	(mm)			
B 020 022 050	20	22	22.00	12.00	50.00	–	US 0608	0.17
B 020 022 100	20	22	22.00	12.00	100.00	–	US 0608	0.34
B 025 027 055	25	27	27.00	15.00	55.00	–	US 0609	0.17
B 025 027 100	25	27	27.00	15.00	95.00	–	US 0609	0.46
B 032 032 060	32	32	32.00	20.00	60.00	–	US 0810	0.43
B 032 032 100	32	32	32.00	20.00	100.00	–	US 0810	0.69
B 032 032 160	32	32	32.00	20.00	160.00	–	US 0810	1.11
B 032 042 090	32	32	32.00	24.00	90.00	–	US 0810	0.71
B 040 042 090	40	42	42.00	24.00	90.00	–	US 1014	0.98
B 040 042 160	40	42	42.00	24.00	160.00	–	US 1014	1.79



EXT-BS



EXT-BS Prodloužení pro vyvrtávací hlavy

Prodloužení pro vyvrtávací hlavy s CZC MS - velikost upínače 22 - 100. Dostupné jsou verze s vnitřním i vnějším chlazením. Vhodný pro aplikace vyžadující velkou přesnost a opakovatelnost procesu.

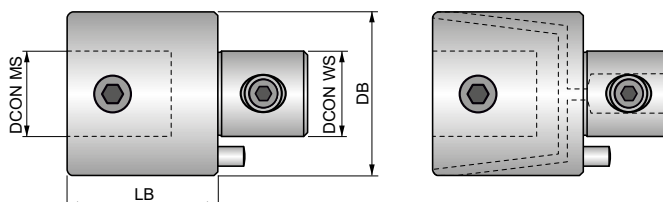

Produkt	CZC MS	BD (mm)	DCON MS (mm)	DCON WS (mm)	LB (mm)			kg
P 022 030 R	22	22.00	12.00	12.00	30.00	✓	US 0608	0.09
P 027 030 R	27	27.00	15.00	15.00	30.00	✓	US 0609	0.13
P 032 035 R	32	32.00	20.00	20.00	35.00	✓	US 0810	0.20
P 042 040 R	42	42.00	24.00	24.00	40.00	✓	US 1014	0.40
P 054 050 R	54	54.00	28.00	28.00	50.00	✓	US 1219	0.85
P 068 060 R	68	68.00	36.00	36.00	60.00	✓	US 1625	1.61
P 085 070 R	85	85.00	50.00	50.00	70.00	✓	US 1630	2.88
P 100 080 R	100, 200	100.00	60.00	60.00	80.00	✓	US 2032	4.48
P 022 020	22	22.00	12.00	12.00	20.00	-	US 0608	0.06
P 022 030	22	22.00	12.00	12.00	30.00	-	US 0608	0.09
P 027 030	27	27.00	15.00	15.00	30.00	-	US 0609	0.13
P 027 045	27	27.00	15.00	15.00	45.00	-	US 0609	0.19
P 032 035	32	32.00	20.00	20.00	35.00	-	US 0810	0.20
P 032 052	32	32.00	20.00	20.00	52.00	-	US 0810	0.30
P 042 040	42	42.00	24.00	24.00	40.00	-	US 1014	0.40
P 042 060	42	42.00	24.00	24.00	60.00	-	US 1014	0.60
P 054 050	54	54.00	28.00	28.00	50.00	-	US 1219	0.87
P 054 075	54	54.00	28.00	28.00	75.00	-	US 1219	1.30
P 068 060	68	68.00	36.00	36.00	60.00	-	US 1625	1.63
P 068 090	68	68.00	36.00	36.00	90.00	-	US 1625	2.44
P 085 070	85	85.00	50.00	50.00	70.00	-	US 1630	2.86
P 085 105	85	85.00	50.00	50.00	105.00	-	US 1630	4.46
P 100 080	100, 200	100.00	60.00	60.00	80.00	-	US 2032	4.44
P 100 120	100, 200	100.00	60.00	60.00	120.00	-	US 2032	6.91



RED-BS

PRAMET



RED-BS Redukce pro vyvrtávací hlavy

Redukce pro vyvrtávací hlavy s průměrem spojovací části od 27 do 100 mm a různými délkami. Vhodný pro aplikace vyžadující velkou přesnost a opakovatelnost procesu.

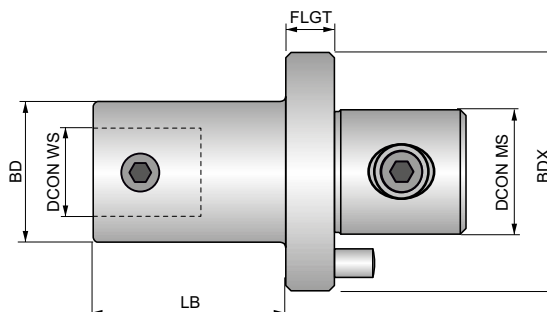

Produkt	CZC MS	BDX	DCON MS	BD	DCON WS	LB	FLGT			
		(mm)	(mm)	(mm)	(mm)	(mm)	(mm)			
R 027 022 036	22	27.00	15.00	22	12.00	26.00	10	–	US 0608	0.11
R 042 022 058	22	42.00	24.00	22	12.00	48.00	10	–	US 0608	0.31
R 032 022 040	22	32.00	20.00	22	12.00	30.00	10	–	US 0608	0.17
R 054 022 086	22	54.00	28.00	22	12.00	76.00	10	–	US 0608	0.51
R 068 022 102	22	68.00	36.00	22	12.00	90.00	12	–	US 0608	0.90
R 054 027 080	27	54.00	28.00	27	15.00	70.00	10	–	US 0609	0.63
R 032 027 034	27	32.00	20.00	27	15.00	24.00	10	–	US 0609	0.18
R 042 027 050	27	42.00	24.00	27	15.00	40.00	10	–	US 0609	0.33
R 068 027 095	27	68.00	36.00	27	15.00	83.00	12	–	US 0609	0.97
R 042 032 046	32	42.00	24.00	32	20.00	36.00	10	–	US 0810	0.36
R 054 032 076	32	54.00	28.00	32	20.00	66.00	10	–	US 0810	0.63
R 068 032 090	32	68.00	36.00	32	20.00	78.00	12	–	US 0810	1.08
R 054 042 070	42	54.00	28.00	42	24.00	60.00	10	–	US 1014	0.81
R 068 042 082	42	68.00	36.00	42	24.00	70.00	12	–	US 1014	1.26
R 085 042 095	42	85.00	50.00	42	24.00	83.00	12	–	US 1014	2.06
R 068 054 072	54	68.00	36.00	54	28.00	60.00	12	–	US 1219	1.51
R 085 054 090	54	85.00	50.00	54	28.00	78.00	12	–	US 1219	2.44
R 085 068 100	68	85.00	50.00	68	36.00	88.00	12	–	US 1625	3.32
R 100 085 100	85	100.00	60.00	85	50.00	88.00	12	–	US 1630	5.05



LA-BS



LA-BS Adaptér pro vyvrtávací hlavy

Adaptér pro vyvrtávací hlavy s CZC MS - velikost 300 - 500, pro upínače velikosti 100. Vhodný pro aplikace vyžadující velkou přesnost a opakovatelnost procesu. Pouze vnější chlazení.

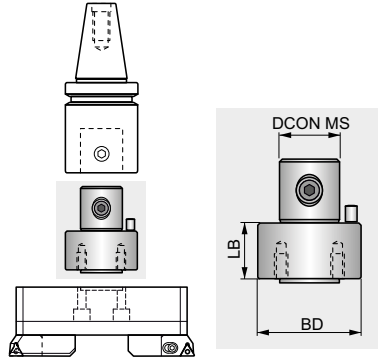

Produkt	CZC MS	BD (mm)	DCON MS (mm)	LB (mm)			
ADT 100 050	300, 400, 500	100.00	60.00	50.00	–	US 1240	4.35



VYVRTÁVACÍ KITY



VYVRTÁVACÍ KITY - OZNAČENÍ

1	2	3	4	5
BS	54	KIT	RC	8-43

1		2	3		4		5
Typ nástroje		Velikost hlavy	Typ		Tvar VBD		Rozsah vyvrtávání
BS	Vyvrtávací systém	54	KIT	Sada nářadí	RC	Pro destičky tvaru C $\kappa = 95^\circ$	8 – 43 (mm)
							8 – 100 (mm)
BS	Vyvrtávací systém	54	KIT	Sada nářadí	TC	Pro destičky tvaru T $\kappa = 90^\circ$	8 – 170 (mm)
							8 – 210 (mm)

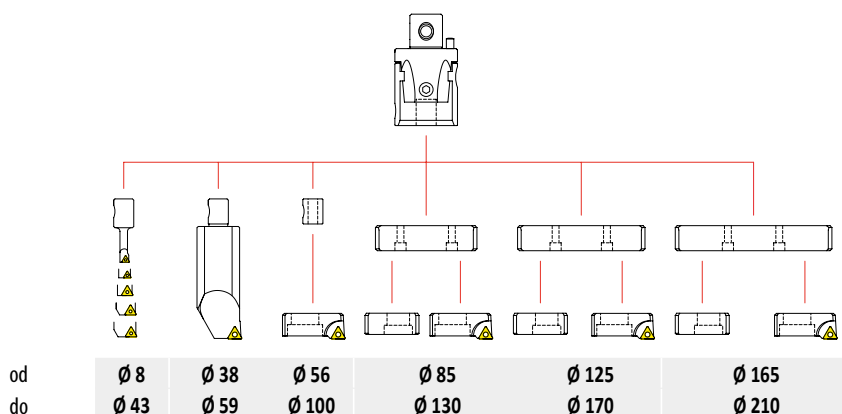

Rozsah	Součásti	Objednáací číslo	
$\emptyset 8 \sim \emptyset 43$		BS 54 KIT RC 8-043	420
		BS 54 KIT TC 8-043	424
$\emptyset 8 \sim \emptyset 100$		BS 54 KIT RC 8-100	421
		BS 54 KIT TC 8-100	425
$\emptyset 8 \sim \emptyset 170$		BS 54 KIT RC 8-170	422
		BS 54 KIT TC 8-170	426
$\emptyset 8 \sim \emptyset 210$		BS 54 KIT RC 8-210	423
		BS 54 KIT TC 8-210	427



BS 54 KIT RC 8-100

VYVRTÁVACÍ KITY

Ø 8 – 100

OBJEDNACÍ ČÍSLO:



	Popis	Označení	VBD	ks.
1	Vyvrtačací hlava	BS 054 16	-	1
2	Vyvrtačací tyč 6 mm	BS 06 16 R02	EP.. 0502..	1
	Vyvrtačací tyč 8 mm	BS 08 16 R03	CC.. 0602..	1
	Vyvrtačací tyč 10 mm	BS 10 16 R03	CC.. 0602..	1
	Vyvrtačací tyč 12 mm	BS 12 16 R03	CC.. 0602..	1
	Vyvrtačací tyč 16 mm	BS 16 16 R04	CC.. 09T3..	1
3	Vyvrtačací tyč 34 mm	BS 34 16 R04	CC.. 09T3..	2
4	Kazeta	BS 2CT R04	CC.. 09T3..	1
5	Pouzdro	BS 16 M10	-	1
6	Imbus 3	HK 03	-	1
	Imbus 5	HK 05	-	1
	Imbus 6	HK 06	-	1
	Imbus 8	HK 08	-	1
7	Klíč Torx 7	TK07	-	1
	Klíč Torx 8	TK08	-	1
	Klíč Torx 15	TK15	-	1
8	Šroub kazety	CS 10 25	-	1

Ø 8 – 170

OBJEDNACÍ ČÍSLO:

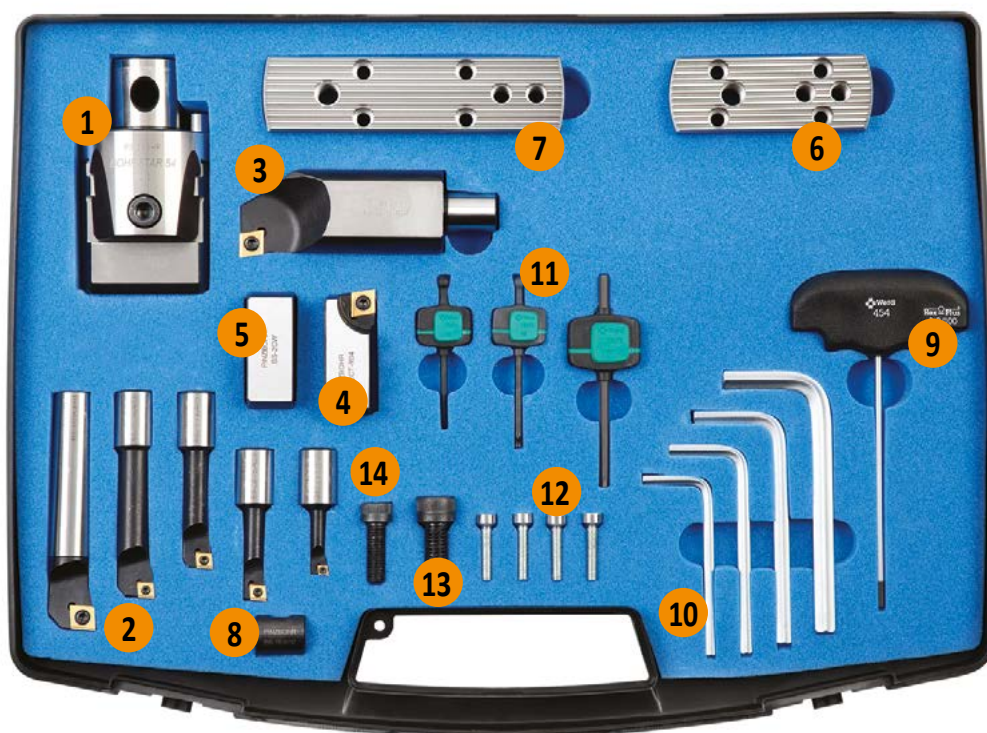

	Popis	Označení	VBD	ks.
1	Vyvrtačací hlava	BS 054 16	-	1
2	Vyvrtačací tyč 6 mm	BS 06 16 R02	EP.. 0502..	1
	Vyvrtačací tyč 8 mm	BS 08 16 R03	CC.. 0602..	1
	Vyvrtačací tyč 10 mm	BS 10 16 R03	CC.. 0602..	1
	Vyvrtačací tyč 12 mm	BS 12 16 R03	CC.. 0602..	1
	Vyvrtačací tyč 16 mm	BS 16 16 R04	CC.. 09T3..	1
3	Vyvrtačací tyč 34 mm	BS 34 16 R04	CC.. 09T3..	2
4	Kazeta	BS 2CT R04	CC.. 09T3..	1
5	Závaží	BS 2CW	-	1
6	Deska - S	BS SP 85 130	-	1
7	Deska - M	BS SP 125 170	-	1
8	Pouzdro	BS 16 M10	-	1
9	Nastavovací klíč	AK 03	-	1
10	Imbus 4	HK 04	-	1
	Imbus 5	HK 05	-	1
	Imbus 6	HK 06	-	1
	Imbus 8	HK 08	-	1
11	Klíč Torx 7	TK07	-	1
	Klíč Torx 8	TK08	-	1
	Klíč Torx 15	TK15	-	1
12	Upevňovací šroub desky	D 27 21	-	4
13	Šroub kazety	CS 10 25	-	1
14	Šroub závaží	CS 08 25	-	1

Ø 8 – 100

OBJEDNACÍ ČÍSLO:



	Popis	Označení	VBD	ks.
1	Vyvrtačací hlava	BS 054 16	-	1
2	Vyvrtačací tyč 6 mm	BS 06 16 T01	TC.. 06T1..	1
	Vyvrtačací tyč 8 mm	BS 08 16 T01	TC.. 06T1..	1
	Vyvrtačací tyč 10 mm	BS 10 16 T02	TC.. 0902..	1
	Vyvrtačací tyč 12 mm	BS 12 16 T02	TC.. 0902..	1
	Vyvrtačací tyč 16 mm	BS 16 16 T02	TC.. 0902..	1
3	Vyvrtačací tyč 34 mm	BS 34 16 T04	TC.. 16T3..	1
4	Kazeta	BS 2CT T04	TC.. 16T3..	1
5	Pouzdro	BS 16 M10	-	1
6	Imbus 3	HK 03	-	1
	Imbus 5	HK 05	-	1
	Imbus 6	HK 06	-	1
	Imbus 8	HK 08	-	1
7	Klíč Torx 6	TK06	-	1
	Klíč Torx 7	TK07	-	1
	Klíč Torx 15	TK15	-	1
8	Šroub kazety	CS 10 25	-	1

Ø 8 – 170

OBJEDNACÍ ČÍSLO:

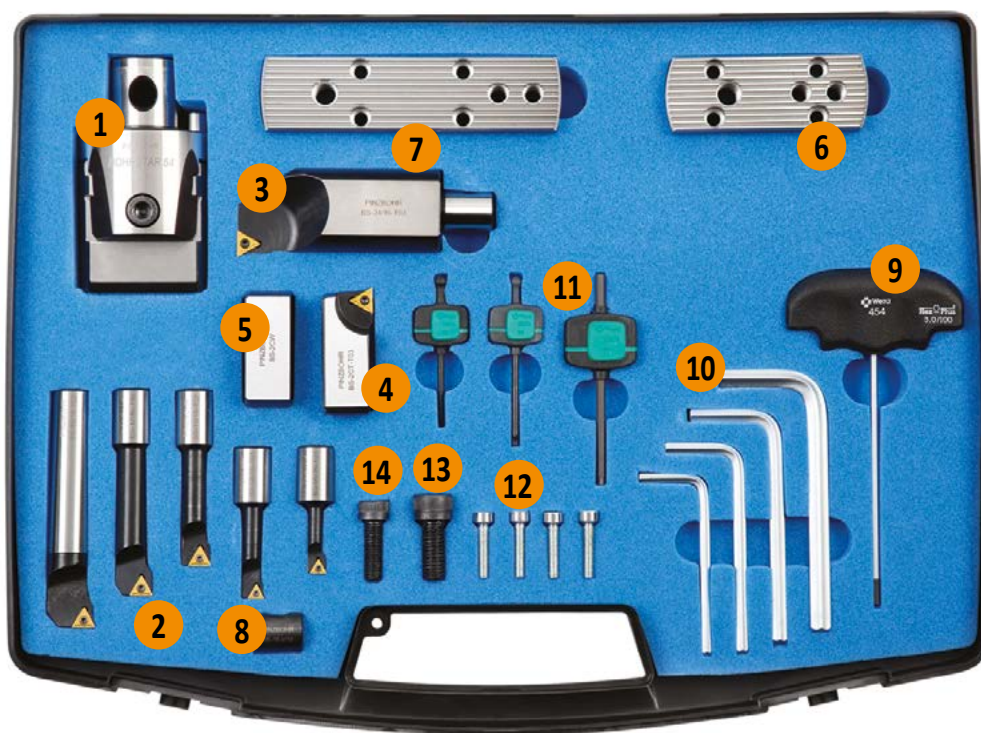

	Popis	Označení	VBD	ks.
1	Vyvrtačací hlava	BS 054 16	-	1
2	Vyvrtačací tyč 6 mm	BS 06 16 T01	TC.. 06T1..	1
	Vyvrtačací tyč 8 mm	BS 08 16 T01	TC.. 06T1..	1
	Vyvrtačací tyč 10 mm	BS 10 16 T02	TC.. 0902..	1
	Vyvrtačací tyč 12 mm	BS 12 16 T02	TC.. 0902..	1
	Vyvrtačací tyč 16 mm	BS 16 16 T02	TC.. 0902..	1
3	Vyvrtačací tyč 34 mm	BS 34 16 T04	TC.. 16T3..	1
4	Kazeta	BS 2CT T04	TC.. 16T3..	1
5	Závaží	BS 2CW	-	1
6	Deska - S	BS SP 85 130	-	1
7	Deska - M	BS SP 125 170	-	1
8	Pouzdro	BS 16 M10	-	1
9	Nastavovací klíč	AK 03	-	1
10	Imbus 4	HK 04	-	1
	Imbus 5	HK 05	-	1
	Imbus 6	HK 06	-	1
	Imbus 8	HK 08	-	1
11	Klíč Torx 6	TK06	-	1
	Klíč Torx 7	TK07	-	1
	Klíč Torx 15	TK15	-	1
12	Upevňovací šroub desky	D 27 21	-	4
13	Šroub kazety	CS 10 25	-	1
14	Šroub závaží	CS 08 25	-	1

Ø 8 – 210

OBJEDNACÍ ČÍSLO:

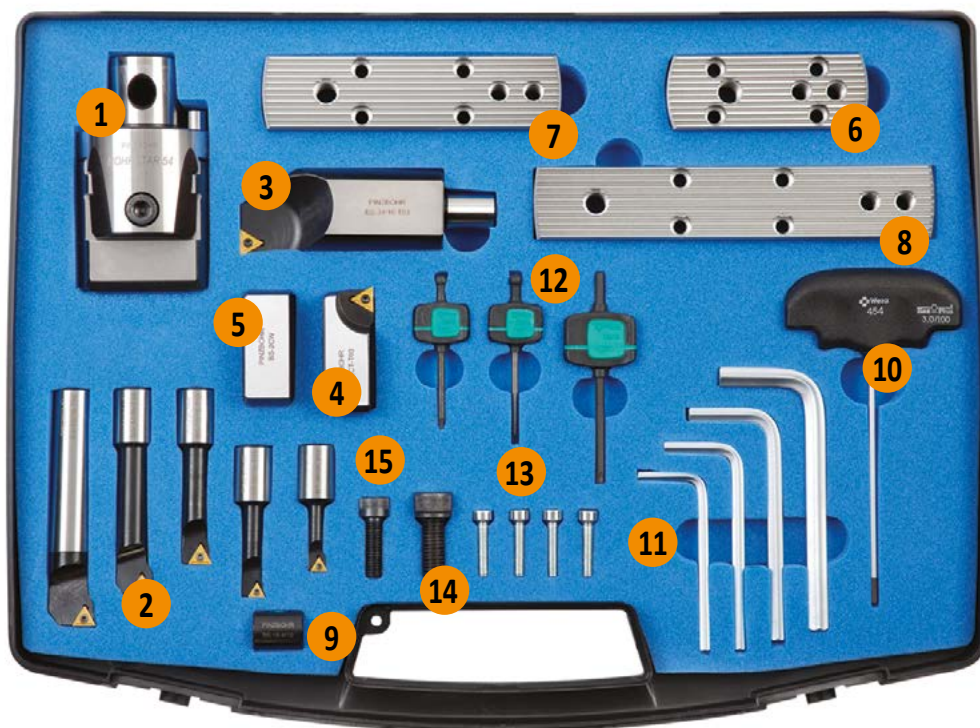

	Popis	Označení	VBD	ks.
1	Vyrtávací hlava	BS 054 16	-	1
2	Vyrtávací tyč 6 mm	BS 06 16 T01	TC.. 06T1..	1
	Vyrtávací tyč 8 mm	BS 08 16 T01	TC.. 06T1..	1
	Vyrtávací tyč 10 mm	BS 10 16 T02	TC.. 0902..	1
	Vyrtávací tyč 12 mm	BS 12 16 T02	TC.. 0902..	1
	Vyrtávací tyč 16 mm	BS 16 16 T02	TC.. 0902..	1
3	Vyrtávací tyč 34 mm	BS 34 16 T04	TC.. 16T3..	1
4	Kazeta	BS 2CT T04	TC.. 16T3..	1
5	Závaží	BS 2CW	-	1
6	Deska - S	BS SP 85 130	-	1
7	Deska - M	BS SP 125 170	-	1
8	Deska - L	BS SP 165 210	-	1
9	Pouzdro	BS 16 M10	-	1
10	Nastavovací klíč	AK 03	-	1
11	Imbus 4	HK 04	-	1
	Imbus 5	HK 05	-	1
	Imbus 6	HK 06	-	1
	Imbus 8	HK 08	-	1
12	Klíč Torx 6	TK06	-	1
	Klíč Torx 7	TK07	-	1
	Klíč Torx 15	TK15	-	1
13	Upevňovací šroub desky	D 27 21	-	4
14	Šroub kazety	CS 10 25	-	1
15	Šroub závaží	CS 08 25	-	1



DORMER PRAMET



VŽDY PŘIPOJEN

Chybí Vám WI-FI nebo připojení k internetu? **Kalkulátor řezných podmínek** funguje perfektně, i když jste OFFLINE. Jsme jednoduše spolehliví.

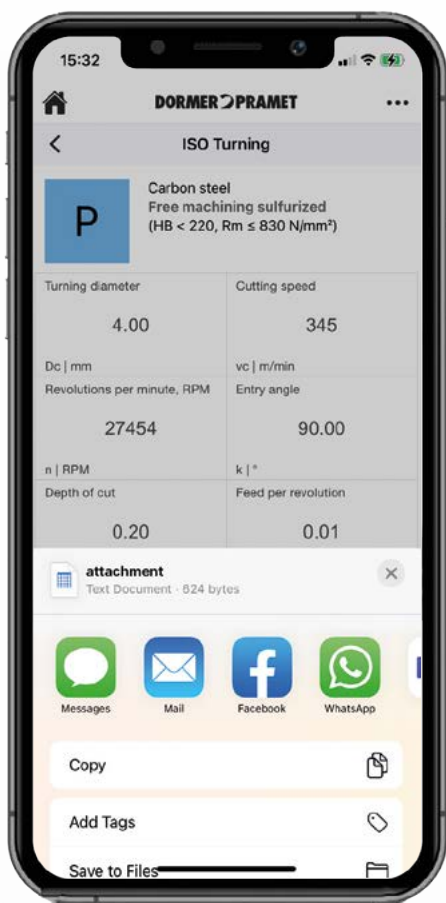



**VYVRTÁVÁNÍ
TECHNICKÉ INFORMACE**



SKUPINY OBRÁBĚNÝCH MATERIÁLŮ (WMG)

ISO Pro výběr materiálu řezného nástroje a geometrie pro širokou škálu materiálů obrobků

Obecná definice
tj. ocel, korozivzdorná ocel...

P **M** **K** **N** **S** **H**

Podskupina Pro volbu vhodného nástroje pro specifičtější rozdělení materiálů obrobků

Rozdělení podle struktury/složení
tj. běžná uhlíková ocel, legovaná ocel...

P **M** **K** **N** **S** **H**

P1

P2

P3

P4

WMG Pro výběr počátečních řezných podmínek s rozsahem $\pm 10\%$

Rozdělení podle tvrdosti/meze pevnosti v tahu
tj. $160 < 220 \text{ HB}$, $620 < 900 \text{ N/mm}^2$...

P

P1 **P1.1** **P1.2** **P1.3**

P2 **P2.1** **P2.2** **P2.3**

P3 **P3.1** **P3.2** **P3.3**

P4 **P4.1** **P4.2** **P4.3**

ROZLIŠENÍ OBRÁBĚNÝCH MATERIÁLŮ SPOLEČNOSTI DORMER PRAMET

Skupiny materiálů obrobků (WMG) se používají k usnadnění výběru správného řezného nástroje a k výběru počátečních řezných podmínek v konkrétním použití.

Norma ISO 513 klasifikuje obráběné materiály do šesti různě zbarvených skupin:

- **Modrá:** ocel a ocelolitina (skupina P)
- **Žlutá:** korozivzdorná ocel (skupina M)
- **Červená:** litina (skupina K)
- **Zelená:** neželezné kovy (skupina N)
- **Hnědá:** žárupevné slitiny (skupina S)
- **Šedá:** kalené materiály (skupina H)

Šest základních ISO skupin se dále dělí na podskupiny na základě struktury a složení materiálů. Například ocel a ocelolitina skupiny P se dělí na tyto čtyři podskupiny:

- **P1 – automatová ocel**
- **P2 – běžná uhlíková ocel**
- **P3 – legovaná ocel**
- **P4 – nástrojová ocel**

Třetí úroveň rozdělení zahrnuje vlastnosti materiálu, jako je tvrdost a mez pevnosti v tahu. Zde poskytujeme našim zákazníkům výběr vhodného nástroje, včetně doporučených počátečních řezných podmínek.

Tabulka na následující straně uvádí popis jednotlivých skupin obráběných materiálů a příklady běžně používaných označení.

Skup. podle ISO	Podskupina	WMG (skupina materiálů obrobků)	k_{pc}	Příklady materiálu (AISI, EN, DIN, ČSN, GB, SS, STN, BS, UNE, AFNOR, ASTM, GOST, UNS, UNI, ...)	
P Ocel a ocelolitina (oceli s obsahem legujících prvků ≤ 10 % a tvrdostí < 45 HRC)	P1 Automatová ocel (uhlíkové oceli se zvýšenou obrobitelností)	P1.1 Automatová uhlíková ocel obsahující síru s tvrdostí < 240 HB	1.33	AISI 1108, EN 1552, DIN 1.0723, SS 1922, ČSN 11120, BS 210A15, UNE F.210F, GB Y15, AFNOR 10F1, GOST A30, UNI CF10S20	
		P1.2 Automatová uhlíková ocel obsahující síru a fosfor s tvrdostí < 180 HB	1.49	AISI 1211, EN 115Mn30, DIN 1.0715, SS 1912, ČSN 11109, BS 230M7, UNE F.2111, GB Y15, AFNOR S250, GOST A40G, UNI CF95Mn28	
		P1.3 Automatová uhlíková ocel obsahující síru, fosfor a olovo s tvrdostí < 180 HB	1.53	AISI 12L13, EN 115MnPb30, DIN 1.0718, SS 1914, ČSN 12110, BS 210M16, UNE F.2114, GB Y15Pb, AFNOR S250Pb, GOST A35G2, UNI CF10SPb20	
	P2 Běžná uhlíková ocel (oceli skládající se převážně z železa a uhlíku)	P2.1 Běžná nízkouhlíková ocel obsahující < 0,25 % C s tvrdostí < 180 HB		1.14	AISI 1015, EN C15, DIN 1.0401, SS 1350, ČSN 11301, BS 080A15, UNE F.111, GB 15, AFNOR C18RR, GOST S22ps, UNI Fe360
		P2.2 Běžná středně uhlíková ocel obsahující < 0,55 % C s tvrdostí < 240 HB		1.00	AISI 1030, EN C30, DIN 1.0528, SS 1550, ČSN 12031, BS 080M32, UNE F.1130, GB 30, AFNOR AF50C30, GOST 30G, UNI Fe590
		P2.3 Běžná vysoce uhlíková ocel obsahující > 0,55 % C s tvrdostí < 300 HB		0.89	AISI 1060, EN C60, DIN 1.0601, SS 1655, ČSN 12061, BS 080A62, UNE F.513, GB 60, AFNOR 1C60, GOST 60G, UNI C60
	P3 Legovaná ocel (uhlíkové oceli s obsahem legujících prvků ≤ 10 %)	P3.1 Legovaná ocel s tvrdostí < 180 HB		0.92	AISI 5015, EN 16Mo3, DIN 1.5415, SS 2912, ČSN 15020, BS 1501-240, UNE F.2601, GB 16Mo, AFNOR 15D3, GOST 15M, UNI 16Mo3KW
		P3.2 Legovaná ocel s tvrdostí 180–260 HB		0.74	AISI 4140, EN 42CrMo4, DIN 1.7225, SS 2244, ČSN 15142, BS 708M40, UNE F.8232, GB 42CrMo, AFNOR 42CD4, GOST 40CHFA, UNI 42CrMo4
		P3.3 Legovaná ocel s tvrdostí 260–360 HB		0.63	AISI 4140, EN 42CrMo4, DIN 1.7225, SS 2244, ČSN 15142, BS 708M40, UNE F.8232, GB 42CrMo, AFNOR 42CD4, GOST 40CHFA, UNI 42CrMo4
	P4 Nástrojová ocel (speciální legovaná ocel pro nástroje, závitová očka a formy)	P4.1 Nástrojová ocel s tvrdostí < 26 HRC		0.55	AISI D2, EN X155CrVMo12-1, DIN 1.2370, SS 2736, ČSN 19573, BS BD2, UNE F.520A, GB Cr12Mo1V1, AFNOR Z160CDV12, GOST Ch12MF, UNI X155CrVMo121KU
		P4.2 Nástrojová ocel s tvrdostí 26–39 HRC		0.47	AISI D2, EN X155CrVMo12-1, DIN 1.2370, SS 2736, ČSN 19573, BS BD2, UNE F.520A, GB Cr12Mo1V1, AFNOR Z160CDV12, GOST Ch12MF, UNI X155CrVMo121KU
		P4.3 Nástrojová ocel s tvrdostí 39–45 HRC		0.38	AISI D2, EN X155CrVMo12-1, DIN 1.2370, SS 2736, ČSN 19573, BS BD2, UNE F.520A, GB Cr12Mo1V1, AFNOR Z160CDV12, GOST Ch12MF, UNI X155CrVMo121KU



SKUPINY MATERIÁLŮ OBROBKŮ (WMG)

Skup. podle ISO	Podskupina	WMG (skupina materiálů obrobků)	k_{vg}	Příklady materiálu (AISI, EN, DIN, ČSN, GB, SS, STN, BS, UNE, AFNOR, ASTM, GOST, UNS, UNI, ...)
M Korozivzdorná ocel (korozivzdorné oceli s obsahem chromu $\geq 11\%$)	M1 Feritická korozivzdorná ocel (běžné chromové nekalitelné slitiny)	M1.1 Korozivzdorná ocel, feritická s tvrdostí < 160 HB	1.22	AISI 5429, EN X7Cr14, DIN 1.4001, SS 2326, BS 434517, UNE F.3401, AFNOR Z8C12, GOST 08Ch13, UNI X6CrTi12
		M1.2 Korozivzdorná ocel, feritická s tvrdostí 160–220 HB	1.03	AISI 446, EN X10CrAl24, DIN 1.4762, SS 2322, ČSN 17113, BS 430517, UNE F.3154, GB 10Cr17, AFNOR Z10CA524, GOST 12Ch17, UNI X16Cr26
		M2.1 Korozivzdorná ocel, martenzitická s tvrdostí < 200 HB	1.08	AISI 430F, EN X14CrMo517, DIN 1.4104, SS 2383, ČSN 17140, BS 410521, UNE F.3117, AFNOR Z10CF17, UNI X10Cr517
	M2 Martenzitická korozivzdorná ocel (běžné chromové kalitelné slitiny)	M2.2 Korozivzdorná ocel, martenzitická s tvrdostí 200–280 HB	0.89	AISI 440C, EN X105CrMo17, DIN 1.4125, SS 2385, ČSN 17023, BS 425C11, UNE F.3402, GB 102Cr17Mo, AFNOR Z100CD17, GOST 95Ch18, UNI GX6CrNi 13 04
		M2.3 Korozivzdorná ocel, martenzitická s tvrdostí 280–380 HB	0.75	AISI 420, EN X45Cr13, DIN 1.4034, ČSN 17029, BS 425C11, UNE F.3405, AFNOR Z44C14, GOST 20X17H12, UNI X30Cr13
		M3.1 Korozivzdorná ocel, austenitická s tvrdostí < 200 HB	1.00	AISI 304, EN X5CrNi18-12, DIN 1.4303, SS 2352, ČSN 17249, BS 305517, UNE F.3513, GB 10Cr18Ni12, AFNOR Z8CN18.12, UNI X7CrNi18 10
	M3 Austenitická korozivzdorná ocel (chrom-niklové a chrom-nikl-manganové slitiny)	M3.2 Korozivzdorná ocel, austenitická s tvrdostí 200–260 HB	0.86	AISI 309, EN X15CrNiSi20-12, DIN 1.4828, ČSN 17251, BS 309S24, UNE F.3312, GB 1G23Ni13, AFNOR Z15CNS20.12, GOST 20Ch20Ni452, UNI 16CrNi23 14
		M3.3 Korozivzdorná ocel, austenitická s tvrdostí 260–300 HB	0.77	AISI 5848, EN X45CrNiW18-9, DIN 1.4873, BS 331540, UNE F.3211, AFNOR Z35CNW514-4, UNI X45CrNiW 18 9
		M4.1 Korozivzdorná ocel, austeniticko-feritická nebo superaustenitická s tvrdostí < 300 HB	0.75	AISI 329, EN X1-NiCrMoCu25-20-5, DIN 1.4539, SS 2562, ČSN 17265, BS 318513, UNE F.3552, GB 022Cr25NiMo2N, AFNOR Z1NCUDU25.20
	M4 Superaustenitická, duplexní nebo precipitačně vytvrzená korozivzdorná ocel (austenitické slitiny s $> 20\%$ Ni, austeniticko-feritickou mikrostrukturou nebo precipitačně vytvrzené)	M4.2 Korozivzdorná ocel, precipitačně vytvrzená austenitická s tvrdostí 300–380 HB	0.64	AISI 631 (17-7PH), EN X7CrNiAl17-7, DIN 1.4568, SS 2388, ČSN 17465, BS 301513, UNE F.3217, GB 07Cr17Ni7Al, AFNOR Z9CNA17-07, GOST 09Ch17Ni7Al, UNI X53CrMnNiN21 9



SKUPINY MATERIÁLŮ OBROBKŮ (WMG)

Skup. podle ISO	Podskupina	WMG (skupina materiálů obrobků)	k_{wc}	Příklady materiálů (AISI, EN, DIN, ČSN, GB, SS, STN, BS, UNE, AFNOR, ASTM, GOST, UNS, UNI, ...)	
K	K1	Šedá litina (GG) (železo-uhlíkové odlitky s lamelární grafitovou mikrostrukturou)	K1.1	Šedá litina, feritická nebo feriticko-perlitická s tvrdostí < 180 HB	ASTM A48 Grade 20 (F11401), EN-JL-100, DIN GG-10 (0.6010), SS 0110, STN 422410, BS Grade 150, UNE FG10, GB HAT 100, AFNOR Fc10D, GOST SC 10, UNI G10
			K1.2	Šedá litina, feriticko-perlitická nebo perlitická s tvrdostí 180–240 HB	ASTM A48 Grade 30 (F12101), EN-JL-1030, DIN GG-20 (0.6020), SS 0120, STN 422420, BS Grade 220, UNE FG20, GB HT200, AFNOR Fc20D, GOST Ч20, UNI G20
			K1.3	Šedá litina, perlitická s tvrdostí 240–280 HB	ASTM A48 Grade 50 (F13501), EN-JL-1060, DIN GG-35 (0.6035), SS 0135, STN 422435, BS Grade 350, UNE FG35, GB HAT300, AFNOR Fc35D, GOST SC35, UNI G35
K	K2	Temperovaná litina (GTS/GTW) (tepelně zúšlechťené železo-uhlíkové odlitky s bezgrafitovou mikrostrukturou)	K2.1	Temperovaná litina, feritická s tvrdostí < 160 HB	ASTM A602 Grade M3210 (F20000), EN-JM-1130, DIN GTS-35 (0.8135), SS 0815, BS B340/12, UNE Type A, AFNOR MN 35-10, GOST K435-10
			K2.2	Temperovaná litina, feritická nebo perlitická s tvrdostí 160–200 HB	ASTM A602 Grade M4504 (F20001), EN-JM-1040, DIN GTS-50-05 (0.8045), BS P50-05, AFNOR MB 45-7
			K2.3	Temperovaná litina, perlitická s tvrdostí 200–240 HB	ASTM A602 Grade M7002 (F20004), EN-JM-1140, DIN GTS-45 (0.8145), SS 0854, STN 422540, BS P 45-06, UNE Typ B, AFNOR MP 50-5, GOST K445-7, UNI GMM 45
K	K3	Tvárná litina (GGG) (železo-uhlíkové odlitky s nodulární grafitovou mikrostrukturou)	K3.1	Tvárná (nodulární/globulární) litina, feritická s tvrdostí < 180 HB	ASTM A536 Grade 60-40-18 (F32800), EN-JS-1030, DIN GGG-40 (0.7040), SS 0717, STN 422304, BS 420/12, UNE FGE 42-12, GB QT 400, AFNOR FGS 400-12, GOST B440
			K3.2	Tvárná (nodulární/globulární) litina, feritická nebo perlitická s tvrdostí 180–220 HB	ASTM A536 Grade 80-55-06 (F33800), EN-JS-1050, DIN GGG-50 (0.7050), SS 0727, STN 422305, BS 500/7, UNE FGE 50-7, GB QT 500-7, AFNOR FGS 500-7, GOST B450
			K3.3	Tvárná (nodulární/globulární) litina, perlitická s tvrdostí 220–260 HB	ASTM A536 Grade 100-70-03 (F34800), EN-JS-1060, DIN GGG-60 (0.7060), SS 0732, STN 422306, BS 600/3, UNE FG70-2, GB QT 600-3, AFNOR FGS 600-3, GOST B460
K	K4	Austenitická nebo izotermicky kalená tvárná litina (Ni-Resist/ADI) (odlitky ze železo-uhlíkových slitin s austenitickou nebo ausferitickou mikrostrukturou)	K4.1	Austenitická litina s tvrdostí < 180 HB	ASTM A436 Type 1 (L-NiCuCr 15 6 2, F41000), EN-JL-3011, DIN GGL-NiMn 13 7 (0.6652), SS 0523, BS Grade F1, AFNOR FGL-Ni13Mn7, GOST S-NiMn 13 7
			K4.2	Austenitická litina s tvrdostí 180–240 HB	ASTM A439 Type D-2B (S-NiCr 20 3, F43001), EN-JS-3021, DIN GGG-NiMn 23 4, SS 0776, BS Grade S2M, AFNOR FGS Ni23 Mn4, GOST ЧH19X3U
			K4.3	Izotermicky kalená tvárná litina s tvrdostí 240–280 HB	ASTM A897 Grade 110-70-11
K	K5	Litina s kompaktním grafitem (CGI) (odlitky ze železo-uhlíkových slitin s vermikulární grafitovou strukturou)	K4.4	Izotermicky kalená tvárná litina s tvrdostí 280–320 HB	ASTM A897 Grade 125-80-10, EN-JS-1100, DIN GGG-90 (5.3400)
			K4.5	Izotermicky kalená tvárná litina s tvrdostí 320–360 HB	ASTM A897 Grade 2 (150-110-07), EN-JS-1110, DIN GGG-100 (5.3403)
			K5.1	Litina s vermikulárním (kompaktním) grafitem s tvrdostí < 180 HB	ASTM A842 Grade 300, EN-GJV-300, DIN GGV 30, GOST ЧBT30,
K	K5		K5.2	Litina s vermikulárním (kompaktním) grafitem s tvrdostí 180–220 HB	ASTM A842 Grade 350, EN-GJV-350, DIN GGV 35 (5.2200), GOST ЧBT30,
			K5.3	Litina s vermikulárním (kompaktním) grafitem s tvrdostí 220–260 HB	ASTM A842 Grade 450, EN-GJV-450, DIN GGV 45, GOST ЧBT45,



SKUPINY MATERIÁLŮ OBROBKŮ (WMG)

Skup. podle ISO	Podskupina	WMG (skupina materiálů obrobků)	k_{vg}	Příklady materiálu (AISI, EN, DIN, ČSN, GB, SS, STN, BS, UNE, AFNOR, ASTM, GOST, UNS, UNI, ...)
N Neželezné kovy (kovy včetně slitin bez znatelného množství železa)	N1 Tvářený hliník	N1.1 Čistý hliník a tvářené slitiny hliníku s tvrdostí < 60 HB	1.33	UNS A91200, EN AL99.6, DIN 3.0205, SS 4010, STN 424009, BS 1C, UNE L-3001, GB L5, AFNOR A4, GOST AĐC, UNI 3567
		N1.2 Tvářené slitiny hliníku s tvrdostí 60–100 HB	1.00	UNS A93004, EN AlMn0.5Mg0.5, DIN 3.0505, SS 4054, STN 424432, BS N31, UNE L-3831, GB LF2, AFNOR A-M1, GOST AMu, UNI 3568
		N1.3 Tvářené slitiny hliníku s tvrdostí 100–150 HB	0.67	UNS A95083, EN AlMg4.5Mn0.7, DIN 3.3547, SS 4140, STN 424415, BS N8, UNE L-3321, GB AlMg4.5Mn, AFNOR A-G4.5Mn, GOST Amg 4.5, UNI P-AlMg4.4
	N2 Odléváný hliník	N2.1 Odlévané slitiny hliníku s tvrdostí < 75 HB	0.67	UNS A02080, EN AlCu45, BS LM11, STN 424331, UNE AlSi1Cu, GOST AMg5K, UNI G-ALSi7Mg
		N2.2 Odlévané slitiny hliníku s tvrdostí 75–90 HB	0.60	UNS A02420, EN AlCu4Ni2Mg2, SS AlSi7MgFe, BS LM6, STN 424519, UNE Al-7SiMg, AFNOR A-S7G, GOST AK7, UNI G-ALSi7Mg
		N2.3 Odlévané slitiny hliníku s tvrdostí 90 < 140 HB	0.43	UNS A03360, EN G-ALCu4NiMg2, SS AlSi10Mg, STN 424336, BS LM 30, AFNOR A-S10G, UNI G-ALSi9Mg
	N3 Měď nebo slitiny mědi	N3.1 Automatové slitiny mědi s vynikajícími vlastnostmi při obrábění	0.70	UNS C14700, EN CuPb1P, DIN 2.1498, STN 423214, BS C111, AFNOR CuZn35Pb2, GOST L63-3, UNI CuS(P0.01)
		N3.2 Slitiny mědi s krátkou tržskou s dobrými nebo středně dobrými vlastnostmi při obrábění	0.41	UNS C81540, EN CuNi25iCr, DIN 2.0857, STN 423220, BS NS113, UNE CuSn12, AFNOR CuZn40, GOST L60, UNI P-CuZn-40
		N3.3 Elektrolytická měď a slitiny mědi s dlouhou tržskou se středně dobrými až nepříznivými vlastnostmi při obrábění	0.21	UNS C10100, EN CuAg0.1, DIN 2.1203, SS 5010, UNE CUSi3Mn1, AFNOR Cu-C2, GOST M1f, UNI Cu-0F
	N4 Polymery (syntetické nebo polosyntetické materiály)	N4.1 Termoplastické polymery	0.70	ABS, Acryl, Duraplast, Elastomer, EP, Epoxid, FEP, Fluor, Gummi, Kautschuk, Latex, ME, MPF, PA, PAI, PC, PE, PEEK, PEI, PES, PET, PF, Phenolharze, PI, PMMA, Polyamide, Polyester, Polyolefine, Polysulfon, POM, PP, PPE, PPS, PS, PSU, PTFE, PU, PUR, PVDF, SAN, SI, Styrol, UF, Ureol
		N4.2 Termosetové polymery	0.27	Aramid, Epoxy, Fluoropolymer, Methacrylate, Melamine, Phenolic, Polyester, Polyimide, Polymethacrylimide, Polyurethane
		N4.3 Vytuzené polymery a kompozity	0.29	CFK, GFK, GMT, Honeycomb, Kevlar, LFT, Organo, SMC
	N5 Grafit	N5.1	1.0	CGM-1, CM-00, GM-10, GM-11, GR030, GR030PI, GR060, GR060PI, GR125, MC-01, MC-01R0, MC-03, MC-03M, IG11, IG-15, IG-32, IG-43, IG-45, IG-70, ISEM-1, ISEM-2, ISEM-3, R8340, R8500X, Technograph 15, Technograph 30, ISO-63, EDM C-3, EDM1, EDM3, ISO-90, ISO-93, ISO-95, R8510, R8650,



SKUPINY MATERIÁLŮ OBROBKŮ (WMG)

Skup. podle ISO	Podskupina	WMG (skupina materiálů obrobků)	k_{wg}	Příklady materiálů (AISI, EN, DIN, ČSN, GB, SS, STN, BS, UNE, AFNOR, ASTM, GOST, UNS, UNI, ...)
	S1 Titan nebo titanové slitiny	S1.1 Titan nebo slitiny titanu, s tvrdostí < 200 HB	1.94	UNS R50250 (Grade 1), EN Ti 99.6, DIN 3.7035, BS TA.2, UNE Ti-Po2, AFNOR T-40, GOST BT1-00, AISI R50250, 3.7025, T35, 2TA1, R50400, 3.7035, 2TAZ,
		S1.2 Slitiny titanu, s tvrdostí 200–280 HB	1.72	UNS R56404 (Grade 29), EN Ti2Cu, DIN 3.7124, BS TA.21, UNE Ti-Pt11, AFNOR T-U2, AISI TA6V, Ti-6Al-4V, Ti 10.2.3, Ti5553
		S1.3 Slitiny titanu, s tvrdostí 280–360 HB	1.44	UNS R54250 (Grade 38), EN TiAl6V4, DIN 3.7165, ČSN TiAl6VELI, BS TA. 13, UNE Ti-P63, AFNOR T-A6V, GOST BT6, AISI TA6V, Ti-6Al-4V, Ti 10.2.3, Ti5553
S Vysokoteplotní slitiny (superslitiny s vysokou tepelnou odolností a odolností proti korozi převyšující korozivzdornou ocel)	S2 Vysokoteplotní slitiny na bázi Fe	S2.1 Vysokoteplotní slitiny na bázi Fe s tvrdostí < 200 HB	1.33	UNS N08801 (Incoloy 801), EN X8 NiCrAlTi31-21, DIN 1.4959, BS NA 15, AFNOR Z8NC33-21, AISI A-286, Discaloy, Haynes 556, Inconel 909, Greek Ascology
		S2.2 Vysokoteplotní slitiny na bázi Fe s tvrdostí 200–280 HB	1.17	UNS N19907, EN X6NiCrTiMoVB25-15-2, DIN 1.4980, SS 2570, BS HR52, AFNOR Z6NCTDV25.15B, GOST 36HXT10, AISI A-286, Discaloy, Haynes 556, Inconel 909, Greek Ascology
	S3 Vysokoteplotní slitiny na bázi Ni	S3.1 Vysokoteplotní slitiny na bázi Ni s tvrdostí < 280 HB	1.00	UNS A09706 (Inconel 706), EN NiCr25FeAl, DIN 2.4856, BS HR 6, ČSN Inconel 625, UNE F.3313, GB 1Cr16Ni35, AFNOR NC22FeDNB, GOST XH38BT, AISI Inconel 718, 706 Waspalloy, Udimet 720, Inconel 625
		S3.2 Vysokoteplotní slitiny na bázi Ni s tvrdostí 280–360 HB	0.83	UNS N07001, EN NiCr20Co13Mo4Ti3Al, DIN 2.4654, BS HR 2, ČSN Waspalloy, AFNOR NCKD 20ATV, GOST XH80T5K0, AISI Inconel 718, 706 Waspalloy, Udimet 720, Inconel 625
	S4 Vysokoteplotní slitiny na bázi Co	S4.1 Vysokoteplotní slitiny na bázi Co s tvrdostí < 240 HB	0.78	UNS R30016 (Stellite 6b), EN CoCr20W15Ni, DIN 2.4964, AFNOR KC 20 WN, GOST ЛК52, AISI Haynes 25, Stellite 21, 31
		S4.2 Vysokoteplotní slitiny na bázi Co s tvrdostí 240–320 HB	0.67	UNS R30016 (Stellite 6b), EN CoCr20W15Ni, DIN 2.4964, AFNOR KC 20 WN, GOST ЛК52, AISI Haynes 25, Stellite 21, 31







SKUPINY MATERIÁLŮ OBROBKŮ (WMG)

Skup. podle ISO	Podskupina	WMG (skupina materiálů obrobků)	k_{vg}	Příklady materiálů (AISI, EN, DIN, ČSN, GB, SS, STN, BS, UNE, AFNOR, ASTM, GOST, UNS, UNI, ...)
H Kalené materiály (jakýkoli strojírenský kov s tvrdostí > 45 HRC)	H1 Tvrzená litina	H1.1 Tvrzená litina s tvrdostí < 440 HB	1.52	UNS F45001, EN-GJS-1050-6, DIN 5.3406, SS 0512, BS Grade 2A
		H2.1 Kalená litina s tvrdostí < 55 HRC	0.90	UNS F45003, EN-GJS-1400-1, DIN 5.3405, SS 0457, BS Grade 3D
	H2 Kalená litina	H2.2 Kalená litina s tvrdostí > 55 HRC	0.77	UNS F45003, EN G-X260NiCr4-2, DIN 0.9620, SS 0466, BS Grade S
		H3.1 Kalená ocel s tvrdostí < 51 HRC	1.00	AISI 4135, EN 34CrMo4, DIN 1.7220, SS 2234, STN 415131, BS 198, UNE F.1250, GB 35CrMo, AFNOR 35CD4, GOST AC38XTM, UNI 35CrMo4KB
	H3 Kalená ocel < 55 HRC	H3.2 Kalená ocel s tvrdostí 51–55 HRC	0.82	AISI 4135, EN 34CrMo4, DIN 1.7220, SS 2234, STN 415131, BS 198, UNE F.1250, GB 35CrMo, AFNOR 35CD4, GOST AC38XTM, UNI 35CrMo4KB
		H4.1 Kalená ocel s tvrdostí 55–59 HRC	0.64	UNS T31501, EN 100MnCrW4, DIN 1.2510, SS 2140, STN 419413, BS B01, UNE F.5220, GB 9CrWMn, AFNOR 90MnWCrV5, GOST 9XBТ, UNI 95MnWCr5KU
	H4 Kalená ocel > 55 HRC	H4.2 Kalená ocel s tvrdostí > 59 HRC	0.54	UNS T31501, EN 100MnCrW4, DIN 1.2510, SS 2140, STN 419413, BS B01, UNE F.5220, GB 9CrWMn, AFNOR 90MnWCrV5, GOST 9XBТ, UNI 95MnWCr5KU

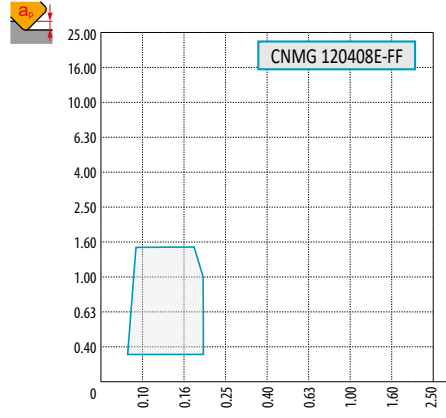
GEOMETRIE NEGATIVNÍCH BŘITVÝCH DESTIČEK – OZNAČENÍ UPÍNÁNÍ ISO P, M, D



FF

P	M	K	N	S	H
■	■	▣			
f	0.06 – 0.25				
a_p	0.2 – 1.6				
					
					
 CNMG, DNMG, TNMG, VNMG, WNMG					

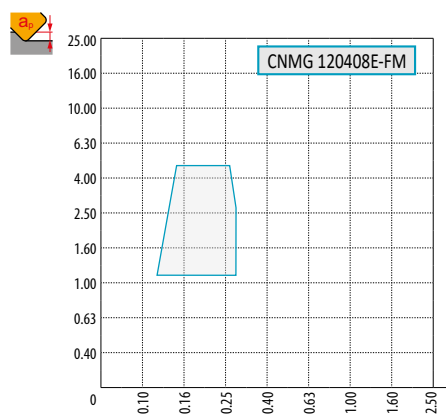

FM

P	M	K	N	S	H
■	▣	■		▣	
f	0.1 – 0.5				
a_p	0.4 – 5.0				
					
					
 CNMG, DNMG, SNMG, TNMG, VNMG, WNMG					

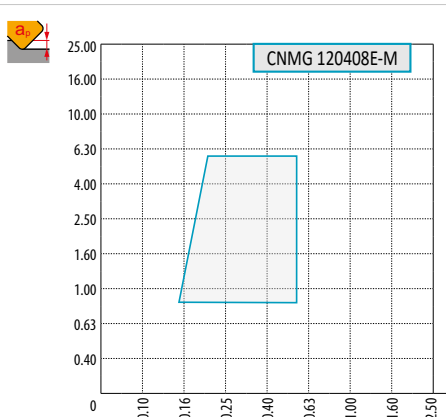

M

P	M	K	N	S	H
■		■			▣
f	0.17 – 0.80				
a_p	0.8 – 8.0				
					
					
 CNMG, DNMG, SNMG, TNMG, VNMG, WNMG					

NF

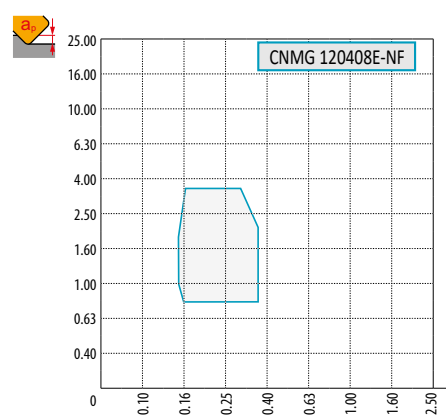



P	M	K	N	S	H
■	■	▣	▣	▣	
f	0.1 – 0.35				
a_p	0.4 – 4.0				
					
					
 CNMG, DNMG, SNMG, TNMG, VNMG, WNMG					



GEOMETRIE NEGATIVNÍCH BŘITOVÝCH DESTIČEK – OZNAČENÍ UPÍNÁNÍ ISO P, M, D

NM



30° 0,25
10°

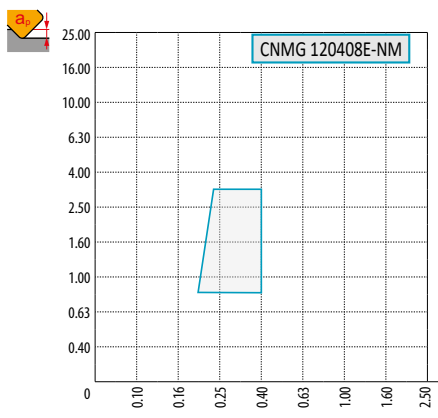

CNMG 120408E-NM

P	M	K	N	S	H
■	■	■	▣	■	
f	0.15 – 0.55				
a_p	0.5 – 8.0				

? CNMG, DNMG, TNMG, VNMG, WNMG

NMR



22° 0,31
10°

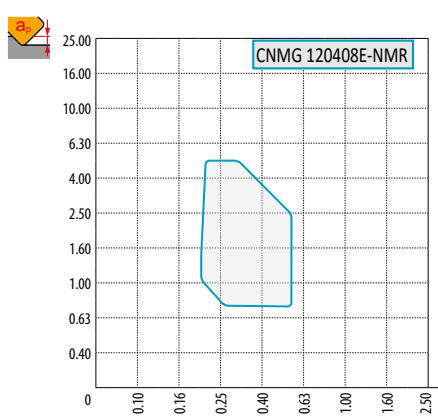

CNMG 120408E-NMR

P	M	K	N	S	H
■	■	■	▣	■	
f	0.18 – 0.70				
a_p	0.4 – 8.0				

? CNMG, DNMG, SNMG, TNMG, VNMG, WNMG

R



0,4
0,1 5° 15°
5°

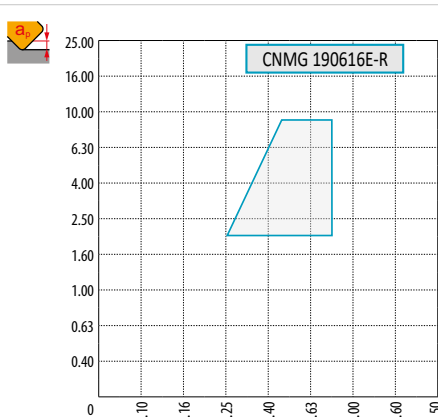

CNMG 190616E-R

P	M	K	N	S	H
■		■	▣		▣
f	0.25 – 0.80				
a_p	2.0 – 9.0				

? CNMG, DNMG, SNMG, TNMG, WNMG

SF



1,94
14,5°

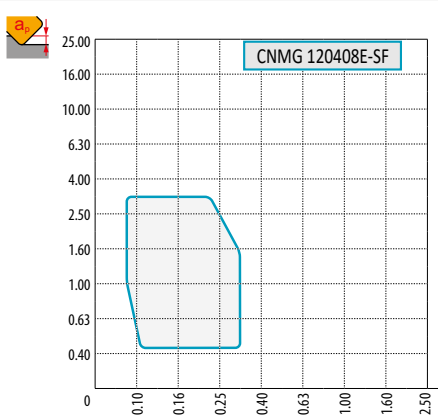

CNMG 120408E-SF

P	M	K	N	S	H
■	■	■	▣	■	■
f	0.08 – 0.35				
a_p	0.2 – 3.5				

? CNGG, CNMG, DNMG, SNMG, TNMG, VNMG, WNMG

GEOMETRIE NEGATIVNÍCH BŘITOVÝCH DESTIČEK – OZNAČENÍ UPÍNÁNÍ ISO P, M, D

SI



15°-18°

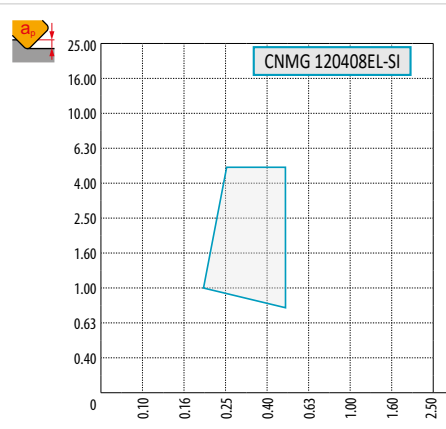

CNMG 120408EL-SI

P	M	K	N	S	H
■	■	■	▣	▣	
f	0.20 – 0.50				
a_p	0.8 – 5.0				



? CNMG, DNMG, TNMG, WNMG

SM



13° 0.25 5°

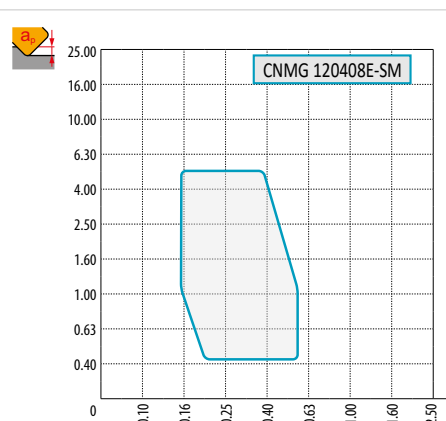



CNMG 120408E-SM



P	M	K	N	S	H
■	■	■	▣	■	▣
f	0.15 – 0.55				
a_p	0.4 – 6.0				



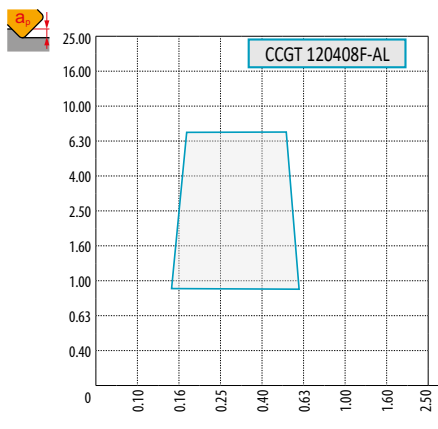
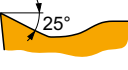

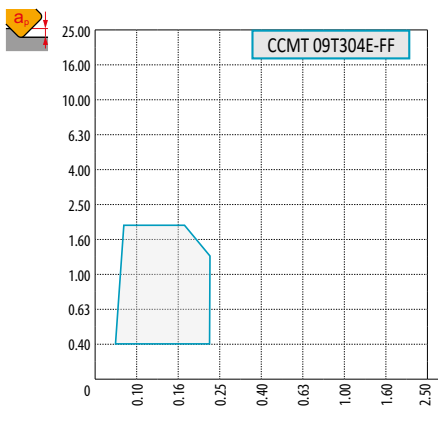
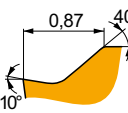

? CNMG, DNMG, SNMG, TNMG, VNMG, WNMG

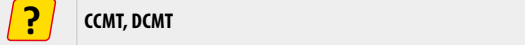
GEOMETRIE POZITIVNÍCH BŘITOVÝCH DESTIČEK – OZNAČENÍ UPÍNÁNÍ ISO S

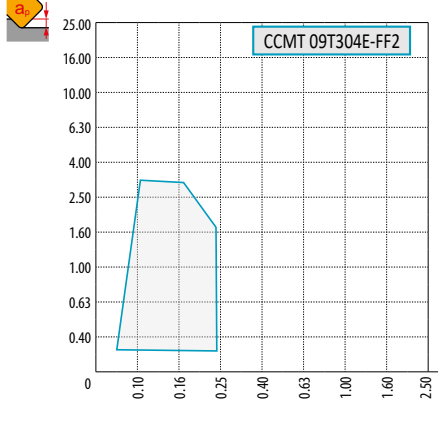
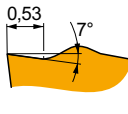
AL		 <p>CCGT 120408F-AL</p>	P	M	K	N	S	H			
			<table border="1"> <tr> <td>f</td> <td>0.05 – 0.60</td> </tr> <tr> <td>a_p</td> <td>0.2 – 7.0</td> </tr> </table>	f	0.05 – 0.60	a_p	0.2 – 7.0				
f	0.05 – 0.60										
a_p	0.2 – 7.0										
			 <p>? CCGT, DCGT, SCGT, RCGT, TCGT, VCGT, WCGT</p>								

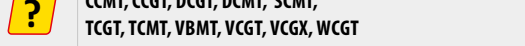
FF		 <p>CCMT 09T304E-FF</p>	P	M	K	N	S	H			
			<table border="1"> <tr> <td>f</td> <td>0.05 – 0.23</td> </tr> <tr> <td>a_p</td> <td>0.2 – 2.0</td> </tr> </table>	f	0.05 – 0.23	a_p	0.2 – 2.0				
f	0.05 – 0.23										
a_p	0.2 – 2.0										
			 <p>? CCMT, DCMT</p>								

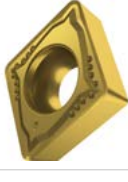
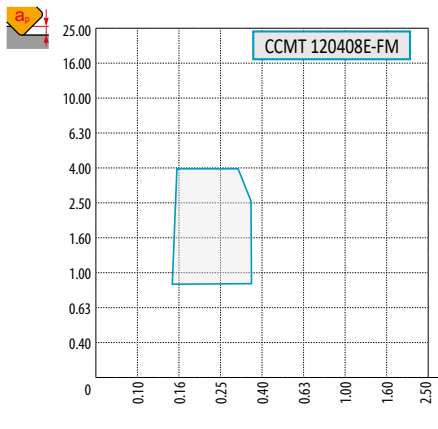
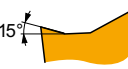
FF2		 <p>CCMT 09T304E-FF2</p>	P	M	K	N	S	H			
			<table border="1"> <tr> <td>f</td> <td>0.02 – 0.28</td> </tr> <tr> <td>a_p</td> <td>0.20 – 3.0</td> </tr> </table>	f	0.02 – 0.28	a_p	0.20 – 3.0				
f	0.02 – 0.28										
a_p	0.20 – 3.0										
			 <p>? CCMT, CCGT, DCGT, DCMT, SCMT, TCGT, TCMT, VBMT, VCGT, VCGX, WCGT</p>								

FM		 <p>CCMT 120408E-FM</p>	P	M	K	N	S	H			
			<table border="1"> <tr> <td>f</td> <td>0.05 – 0.45</td> </tr> <tr> <td>a_p</td> <td>0.2 – 4.0</td> </tr> </table>	f	0.05 – 0.45	a_p	0.2 – 4.0				
f	0.05 – 0.45										
a_p	0.2 – 4.0										
			 <p>? CCMT, DCMT, SCMT, TCMT, VBMT, WCMT</p>								



GEOMETRIE POZITIVNÍCH BŘITOVÝCH DESTIČEK – OZNAČENÍ UPÍNÁNÍ ISO S

FM2

P	M	K	N	S	H
■	■	■			
f	0.04 – 0.4				
a_p	0.2 – 4.0				
?	CCMT, DCMT, ECMT, SCMT, TCMT, VBMT, VCGT				

NF1

P	M	K	N	S	H
■	■	■	■	■	■
f	0.04 – 0.35				
a_p	0.3 – 3.5				
?	CCGT, DCGT, SCGT, TCGT				

NF2

P	M	K	N	S	H
■	■	■	■	■	
f	0.05 – 0.45				
a_p	0.2 – 4.0				
?	CCMT, EPMT, SCMT, TCMT, VCGT				

RF

I. C.	R
6,35	1,0
9,525	1,5
12,7	2,5



P	M	K	N	S	H
■	■	■			■
f	0.10 – 0.60				
a_p	0.8 – 8.0				
?	CCMT, DCMT, SCMT, TCMT, WCMT				



GEOMETRIE POZITIVNÍCH BŘITOVÝCH DESTIČEK – OZNAČENÍ UPÍNÁNÍ ISO S

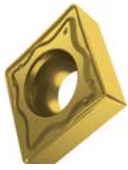
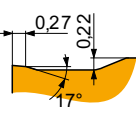
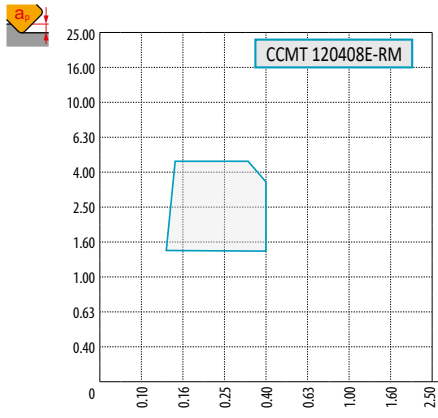

RM

P	M	K	N	S	H
■	■	■	■	■	■
f 0.10 – 0.50					
a _p 0.8 – 4.5					
					
					
 CCMT, DCMT, SCMT, TCMT, VBMT					

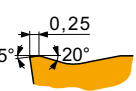
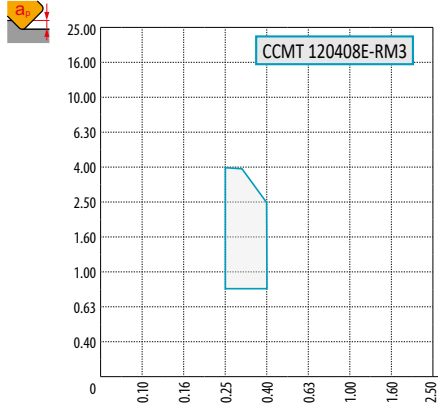

RM3

P	M	K	N	S	H
■	■	■	■	■	■
f 0.15 – 0.90					
a _p 0.4 – 6.00					
					
					
 CCMT, SCMT, TCMT, RCMT					

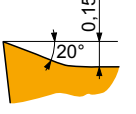
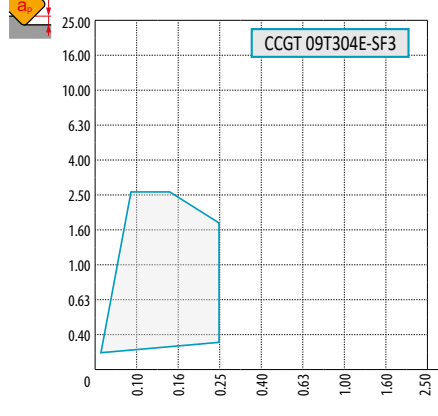

SF3

P	M	K	N	S	H
■	■	■	■	■	■
f 0.02 – 0.35					
a _p 0.2 – 4.00					
					
					
 CCGT, DCGT, ECGT, SCGT, TCGT, VCGT					

SI

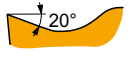
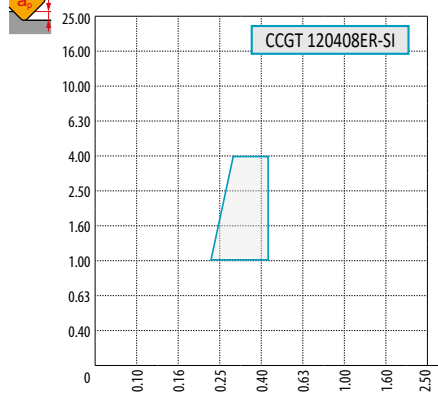



P	M	K	N	S	H
■	■	■	■	■	■
f 0.08 – 0.45					
a _p 0.4 – 4.0					
					
					
 CCGT, TCGT					

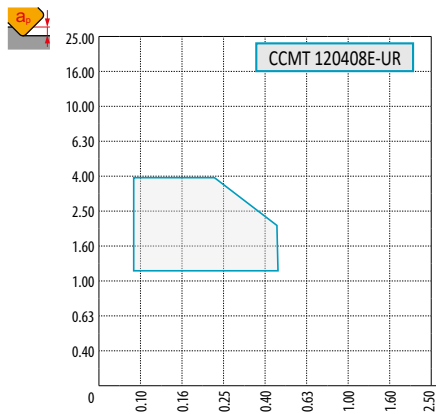
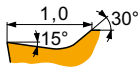

GEOMETRIE POZITIVNÍCH BŘITOVÝCH DESTIČEK – OZNAČENÍ UPÍNÁNÍ ISO S

UR



P	M	K	N	S	H
■	▣	■	■	■	■
	0.10 – 0.40				
	1.0 – 4.0				
	CCMT, DCMT, RCMT, SCMT, TCMT, VCMT, VBMT, WCMT				

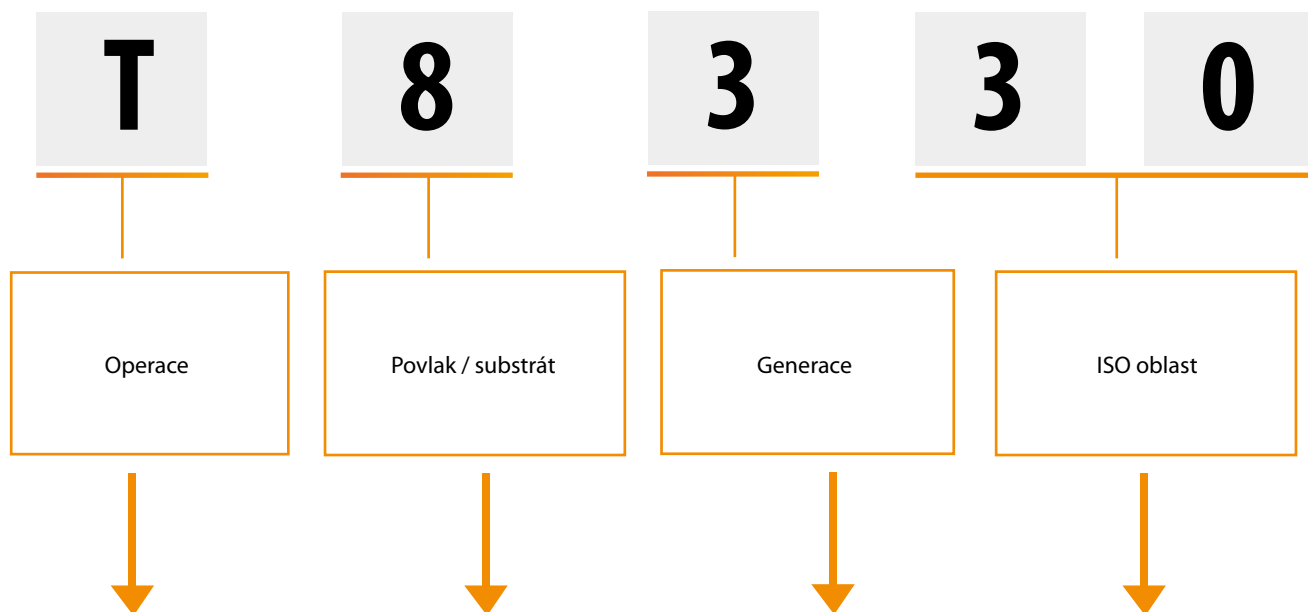

D	Vrtání
M	Frézování
T	Soustružení
G	Zapichování a upichování

0 PVD 1 CVD	Speciální aplikace
2 PVD 3 CVD	Volný
4 PVD 5 CVD	Pro materiály skupiny K, H
6 PVD 7 CVD	Pro materiály skupiny M, S
8 PVD 9 CVD	Univerzální
B	PKBN
C	Keramika
D	PKD
T	Cermet

1 – 9

01 – 50	
	01 – 05
	05 – 10
	10 – 20
	20 – 30
	30 – 40
	40 – 50



VYVRTÁVACÍ MATERIÁLY

Označení materiálu	Aplikační oblast	Použití	Posuv	Řezná rychlost	Odolnost vůči nepříznivým pracovním podmínkám	Povlak	Barva	Substrát	Výhoda chlazení	Popis materiálu
T9315	P05 - P25	■				MT-CVD	■	FGM	++	Univerzální materiál s vynikající odolností proti opotřebení i za intenzivních řezných podmínek. Lze jej použít také pro operace s přerušovaným řezem. Díky svým dobře vyváženým vlastnostem může být tento materiál první volbou pro širokou škálu soustružnických operací. Nevhodný pro nízké řezné rychlosti.
	K05 - K25	■	▴	▴	▴					
	H10 - H20	■								
T9325	P15 - P35	■				MT-CVD	■	FGM	++	Z technologického hlediska se jedná o extrémně univerzální materiál s vysokou odolností proti mechanickému poškození za nepříznivých řezných podmínek, který si zachovává vynikající odolnost proti opotřebení. Správné použití tohoto materiálu vyžaduje vysoké řezné rychlosti.
	M10 - M30	■	▴	▴	▴					
	K15 - K35	■								
	S10 - S20	■								
T9335	P20 - P45	■				MT-CVD	■	FGM	+++	Jeden z nehouzevnatějších materiálů vhodný zejména pro nepříznivé řezné podmínky při středních až vyšších posuvech a středních řezných rychlostech. Oproti svým předchůdcům M15–M40 má nejen vyšší houzevnatost, ale i otěruvzdornost, která vynikne při aplikaci intenzivních řezných podmínek.
	M15 - M40	■	▴	▴	▴					
	S15 - S25	■								
T7325	P15 - P35	■				MT-CVD	■	FGM	+++	Jeden z nejuniverzálnějších materiálů pro soustružení. Určen zejména pro obrábění korozivzdorné oceli. Optimální vyváženost mezi odolností vůči opotřebení a provozní spolehlivostí. Vhodný pro širokou škálu aplikací v soustružnických operacích.
	M10 - M25	■	▴	▴	▴					
	S10 - S25	■								
T7335	P20 - P40	■				MT-CVD	■	FGM	+++	Materiál s funkčně odstupňovaným substrátem vyznačující se velmi vysokou provozní spolehlivostí a velmi dobrou odolností vůči opotřebení. Nejlepší uplatnění nalezne při obrábění velmi houzevnatých materiálů M20–M40.
	M20 - M40	■	▴	▴	▴					
	S15 - S25	■								
T5305	P05 - P15	■				MT-CVD	■	H	+	Materiál s velmi vysokou odolností proti chemickým typům opotřebení; vhodný pro dokončovací operace s vysokou řeznou rychlostí. Díky své vysoké otěruvzdornosti je vhodný i pro produktivní K01–K15, obrábění kalených a zušlechťených materiálů.
	K01 - K15	■	▴	▴	▴					
	H05 - H15	■								
T5315	P10 - P25	■				MT-CVD	■	H	+	Materiál prioritně určený pro produktivní obrábění s vysokou odolností vůči otěru a dobrou provozní spolehlivostí. Díky svým vlastnostem je tento materiál vhodný zejména pro dokončovací a polohrubovací operace za dobrých, až mírně zhoršených záběrových podmínek.
	K10 - K25	■	▴	▴	▴					
	H15 - H25	■								
T0315	N05 - N20	■	▴	▴	▴	PVD	■		++	Submikronový materiál určený k soustružení slitin neželezných kovů a jejich slitin s vyváženým poměrem otěruvzdornosti a houzevnatosti. Je opatřen unikátním povlakem s vynikajícími funkčními vlastnostmi.
T6310	P01 - P15	■				PVD	■	ultra submicron H	+++	Vysoce otěruvzdorný materiál pro soustružení s vynikajícím PVD povlakem. Vhodný pro dokončovací operace a aplikace, kde je velmi důležitá ostrá řezná hrana spolu s vysokou odolností proti opotřebení hříbetu.
	M01 - M15	■	▴	▴	▴					
	K05 - K20	■								
	N05 - N20	■								
	S01 - S15	■								
T8315	P05 - P20	■				PVD	■	submicron H	++	Materiál s vynikající otěruvzdorností při zachování nadprůměrné provozní spolehlivosti, který je vhodný pro obrábění při středních až vysokých řezných rychlostech u tvrdších materiálů s krátkou třiskou.
	M05 - M20	■	▴	▴	▴					
	K05 - K25	■								
	N05 - N25	■								
	S05 - S15	■								



VYVRTÁVACÍ MATERIÁLY

Označení materiálu	Aplikační oblast	Použití	Posuv	Řezná rychlost	Odolnost vůči nepříznivým pracovním podmínkám	Povlak	Barva	Substrát	Výhoda chlazení	Popis materiálu
T8330	P25 - P40	■				PVD		submicron H	+++	Bezporu nejuniverzálnější řezný materiál využitelný pro obrábění všech typů obráběných materiálů a prakticky aplikovatelný skoro ve všech typech soustružnických operací. Jeho hlavní výhodou je vysoká provozní spolehlivost a velmi dobré funkční vlastnosti; je proto vhodný pro použití při středních a nižších řezných rychlostech.
	M20 - M35	■								
	K20 - K40	■								
	N15 - N30	■								
	S15 - S25	■								
H15 - H25	■									
T8430	P20 - P40	■				PVD		submicron H	+++	Bezporu nejuniverzálnější řezný materiál využitelný pro obrábění všech typů obráběných materiálů a prakticky aplikovatelný skoro ve všech typech soustružnických operací. Jeho hlavní výhodou je vysoká provozní spolehlivost a velmi dobré frikční vlastnosti; je proto vhodný pro použití při středních a nižších řezných rychlostech.
	M20 - M35	■								
	K25 - K40	■								
	N15 - N30	■								
	S15 - S25	■								
H15 - H25	■									
HF7	M10 - M20	■				×		submicron H	++	Nepovlakovaný materiál určený především pro obrábění neželezných kovů; lze ho však použít i pro ostatní obráběné materiály (s výjimkou ocelí). Tento materiál najde své uplatnění v oblasti soustružení, frézování, a dokonce i vyvrtávání.
	K10 - K25	■								
	N10 - N25	■								
H07	M05 - M15	■				×		submicron H	++	Nepovlakovaný materiál pro soustružení vhodný pro obráběcí aplikace, kde dominujícím kritériem životnosti nástroje není odolnost proti oxidaci. Určen pro obrábění slitin na bázi Ti. Materiál vykazuje vysokou pevnost řezné hrany spolu s dobrou odolností vůči opotřebení.
	K10 - K25	■								
	N10 - N30	■								
	S01 - S20	■								
TT310	P10 - P25	■				PVD		Cermet	+ / -	Povlakovaný cermet určený pro jemné a dokončovací soustružení uhlíkových i slitinových ocelí (včetně korozivzdorných). Vynikající funkční vlastnosti jsou ještě umocněny povlakem naneseným metodou PVD.
	M15 - M25	■								
TT010	P01 - P10	■				×		Cermet	+ / -	Nepovlakovaný cermet vhodný pro jemné obrábění všech typů ocelí (včetně korozivzdorných) při velmi nízkých posuvech. Jeho hlavní výhodou je minimální zaoblení řezné hrany a její vysoká odolnost vůči fyzikálně-chemickým mechanickým opotřebení.
	M01 - M10	■								
PD1	N05 - N25	■				×		PCD	--	Materiál PKD pro soustružení neželezných materiálů. Ideální volba pro práci s vysokou řeznou rychlostí a malými posuvy za stabilních podmínek.
TB310	K01 - K10	■				×		CBN	--	Materiál CBN pro obrábění kalených materiálů. Vhodný pro obrábění s vysokou řeznou rychlostí a malými posuvy za stabilních podmínek.
	S05 - S10	■								
	H01 - H10	■								

Substrát

H	Substrát na bázi WC-Co
submicron H	Substrát na bázi WC-Co (< 1 mm)
ultra submicron H	Ultra jemnozrný substrát na bázi WC-Co
FGM	Funkční gradientní substrát
Cermet	Slitný karbid bez WC
PCD	Polykrystalický diamant
CBN	Polykrystalický kubický nitrid boru

Povlak

MT-CVD	Středně teplotní chemická metoda povlakování
PVD	Nízkoteplotní fyzikální metoda povlakování
×	Bez povlaku

Přínos řezné kapaliny

+++	Velmi vysoký přínos
++	Vysoký přínos
+ / -	Sporný přínos
--	Velmi nepříznivý dopad chlazení



TABULKA ŘEZNÝCH PODMÍNEK PRO VYVRTÁVÁNÍ

Ve vyvrtávacích nožích se používají standardní destičky pro soustružení, ale neplatí zde podmínky doporučené pro soustružení (údaje uvedené na krabicích), proto vyberte řezné podmínky podle následující tabulky.

Materiál	Dokončování (s jednou destičkou)				Hrubování (s dvěma destičkami)								
	Rozměr	Řezná rychlost v_c	Posuv f_z	Hloubka řezu a_p	Rozměr	Řezná rychlost v_c	Posuv f_z	Hloubka řezu a_p					
P	24 – 30	110 – 140	0.05 – 0.15	0.05 – 0.30	24 – 30	110 – 140	0.15 – 0.25	4.2					
	29 – 40	115 – 150			0.10 – 0.20	0.06 – 0.35	29 – 40	105 – 140	0.15 – 0.30	5.7			
	39 – 50		0.07 – 0.50	0.30 – 0.40			39 – 50	105 – 150	0.20 – 0.30	6.3			
	49 – 102				0.07 – 0.50	0.25 – 0.35	49 – 102		105 – 150		0.30 – 0.40		
	100 – 220						0.07 – 0.50					0.30 – 0.40	100 – 220
	220 – 500		0.07 – 0.50	0.30 – 0.40	220 – 500	105 – 150		0.30 – 0.40					
220 – 500	0.07 – 0.50	0.30 – 0.40			220 – 500		105 – 150		0.30 – 0.40				
M			24 – 30	70 – 110	0.07 – 0.15	0.12 – 0.35		24 – 30		69 – 90	0.12 – 0.20	4.2	
	29 – 40	80 – 110	0.12 – 0.20	0.20 – 0.50			29 – 40	70 – 100	0.15 – 0.25	5.7			
	39 – 50				0.12 – 0.20	0.25 – 0.75	39 – 50		70 – 100	0.20 – 0.30	6.3		
	49 – 102		0.12 – 0.20	0.25 – 0.75			49 – 102			70 – 100		0.25 – 0.35	
	100 – 220						0.12 – 0.20					0.25 – 0.75	100 – 220
	220 – 500		0.12 – 0.20	0.25 – 0.75	220 – 500	70 – 100			0.25 – 0.35				
220 – 500	0.12 – 0.20	0.25 – 0.75			220 – 500		70 – 100	0.25 – 0.35					
K			24 – 30	70 – 110	0.07 – 0.15	0.12 – 0.35		24 – 30	60 – 110	0.20 – 0.30	4.2		
	29 – 40	80 – 115	0.12 – 0.20	0.20 – 0.50			29 – 40	60 – 110		0.25 – 0.35	5.7		
	39 – 50				0.12 – 0.20	0.25 – 0.75	39 – 50			60 – 110	0.30 – 0.40	6.3	
	49 – 102		0.12 – 0.20	0.25 – 0.75			49 – 102				60 – 110		0.30 – 0.45
	100 – 220						0.12 – 0.20						0.25 – 0.75
	220 – 500		0.12 – 0.20	0.25 – 0.75	220 – 500	60 – 110				0.30 – 0.45			
220 – 500	0.12 – 0.20	0.25 – 0.75			220 – 500		60 – 110	0.30 – 0.45					
N			24 – 30	150 – 300	0.05 – 0.15	0.12 – 0.35		24 – 30	120 – 300	0.20 – 0.30	4.2		
	29 – 40	150 – 360	0.10 – 0.20	0.20 – 0.50			29 – 40	150 – 370	0.25 – 0.35	5.7			
	39 – 50				0.10 – 0.25	0.25 – 0.75	39 – 50		150 – 370	0.30 – 0.40	6.3		
	49 – 102		0.10 – 0.25	0.25 – 0.75			49 – 102			150 – 370		0.30 – 0.45	
	100 – 220						0.10 – 0.25					0.25 – 0.75	100 – 220
	220 – 500		0.10 – 0.25	0.25 – 0.75	220 – 500	150 – 370			0.30 – 0.45				
220 – 500	0.10 – 0.25	0.25 – 0.75			220 – 500		150 – 370	0.30 – 0.45					
S			24 – 30	30 – 40	0.07 – 0.15	0.12 – 0.35		24 – 30	25 – 35	0.12 – 0.20	4.2		
	29 – 40	30 – 45	0.10 – 0.20	0.20 – 0.50			29 – 40	30 – 40	0.15 – 0.25	5.7			
	39 – 50				0.10 – 0.20	0.25 – 0.75	39 – 50		30 – 40	0.20 – 0.30	6.3		
	49 – 102		0.10 – 0.20	0.25 – 0.75			49 – 102			30 – 40		0.20 – 0.35	
	100 – 220						0.10 – 0.20					0.25 – 0.75	100 – 220
	220 – 500		0.10 – 0.20	0.25 – 0.75	220 – 500	30 – 40			0.20 – 0.35				
220 – 500	0.10 – 0.20	0.25 – 0.75			220 – 500		30 – 40	0.20 – 0.35					
H			24 – 30	30 – 40	0.07 – 0.15	0.12 – 0.35		24 – 30	25 – 35	0.12 – 0.20	4.2		
	29 – 40	30 – 45	0.20 – 0.50	0.25 – 0.75			29 – 40	30 – 40	0.15 – 0.25	5.7			
	39 – 50				0.25 – 0.75	0.25 – 0.75	39 – 50		30 – 40	0.20 – 0.30	6.3		
	49 – 102		0.25 – 0.75	0.25 – 0.75			49 – 102			30 – 40		0.20 – 0.35	
	100 – 220						0.25 – 0.75					0.25 – 0.75	100 – 220
	220 – 500		0.25 – 0.75	0.25 – 0.75	220 – 500	30 – 40			0.20 – 0.35				
220 – 500	0.25 – 0.75	0.25 – 0.75			220 – 500		30 – 40	0.20 – 0.35					

Postup seřízení – hrubovací hlavy

- Upněte nové destičky do lůžek.
- Povolte zajišťovací šroub posuvných ramen a opět dotáhněte velmi lehce.
- Otáčením seřizovacího šroubu nastavte posuvná ramena na menší průměr než je vámi požadovaný.
- Zpětným otáčením seřizovacího šroubu nastavte posuvná ramena na požadovaný průměr.
- Nastavení může být provedeno s hlavou nebo držákem upnutým ve stroji, mimo stroj nebo v seřizovacím přípravku.
- Utáhněte zajišťovací šroub v seřizovacím přípravku.



Pro hlavy o velikost 68 a větší (kazetový typ)

- Kazety mají samostatné radiální seřizovací šrouby.
- Povolte zajišťovací šroub jedné ze dvou kazet.
- Otáčením seřizovacího (stavěcího) šroubu ustavte kazetu dokud nejsou obě destičky vystředěny ($R1 = R2$).

Postup seřízení – dokončovací hlavy

- Všechny dokončovací hlavy a mikrohlavy mají mikrometrické nastavení s velikostí dílku 0,002 mm.
- Upněte do lůžka novou destičku.
- Nastavení by mělo být provedeno přednostně v porovnávacím nebo seřizovacím přípravku.
- Povolte zajišťovací šroub posuvného ramene a opět dotáhněte velmi lehce.
- Otáčením seřizovacího šroubu nastavte posuvné rameno na menší průměr než je vámi požadovaný.
- Zpětným otáčením seřizovacího šroubu nastavte posuvné rameno na požadovaný průměr, dokud se destička neobjeví v nitkovém kříži.
- Utáhněte zajišťovací šroub.
- Pro aplikace, které vyžadují specifické tolerance otvorů, doporučujeme nastavit hlavu zpočátku na menší průměr, vyvrtat díru a proměřit ji. Následně nastavte hlavu na příslušnou hodnotu s pomocí úchytkoměru a proveďte další průjezd.



Volba úhlu nastavení hlavního břitu

75°



90°



- Průchozí otvory
- Těžké hrubování při zvýšených rychlostech posuvu
- Pozor má tendenci kopírovat existující povrch
- Hluboké otvory – dlouhé vyvrtávací nástroje (samostředící efekt pomáhá při nájezdu!)

- Slepé otvory
- Vyvrtávání kolmo pod 90°
- Mělké otvory – krátké vyvrtávací nástroje (zarovnávání a převrtávání posunutých otvorů)
- Vyvrtávání s přesazenými kazetami (velikost 68 a větší)

Tyto typy vyvrtávacích hlav mohou být osazeny jednou symetrickou kazetou a jednou přesazenou kazetou. Přesazená kazeta má písmeno „S“ na konci označení.

Příklad: 2CT 90 402 N S; 2CT 90 300 S; 2CT 90 402 S.

Symetrické vyvrtávání

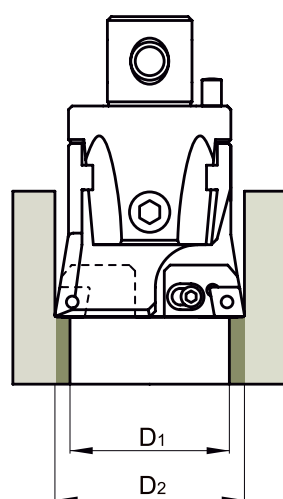

Stupňovité vyvrtávání

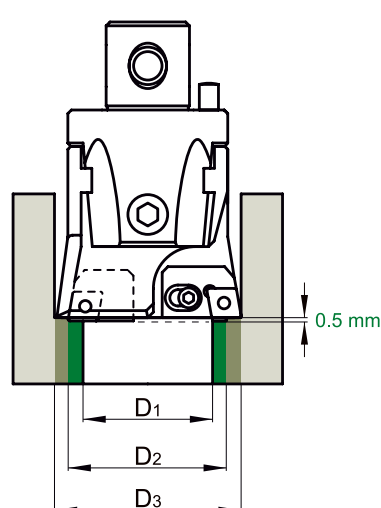

2CT □□ □□□ + 2CT □□ □□□
3CT □□ □□□ + 3CT □□ □□□

2CT □□ □□□ S + 2CT □□ □□□
3CT □□ □□□ S + 3CT □□ □□□

Přesazené vyvrtávání umožňuje zvýšení objemu odebraného materiálu mezi průměry D1 a D3 během jednoho průjezdu, přibližně o 4 až 6 mm ve srovnání se symetrickým vyvrtáváním.

Nezapomeňte, že pro přesazené vyvrtávání se posuv za minutu vypočte, jako by se jednalo o **jednobřítý nástroj**.



MONTÁŽ VYVRTÁVACÍCH HLAV

Upozornění: V průběhu celé montáže a demontáže musí být zajišťovací šroub (pozice 2) uvolněn.

Postup upevnění vyvrtávací hlavy k upínači

Odmontujte upínací šrouby (pozice 1) a tlakem do strany vysuňte posuvníky, do pozice, než se objeví čtyři otvory pro upínací šrouby. Zasuňte upínač do osazení na vyvrtávací hlavě, vystředte na pozice upínacích otvorů a vložte a utáhněte všechny čtyři upínací šrouby M12x40.

DOKONČOVÁNÍ

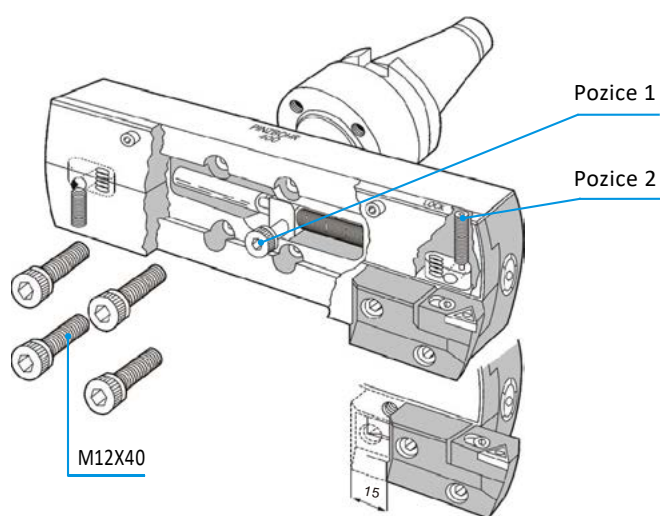

Rychlosti a posuvy

Finální nebo optimální řezné rychlosti a posuvy budou záviset na obráběném materiálu, obráběcím stroji a podmínkách nastavení, stejně jako i na velikosti vyložení nástroje.

Hloubka vyvrtávání – vyložení nástroje při hrubování a dokončování

Dobrych výsledků s karbidovými nástroji lze dosáhnout za podmínek vrtání při hloubkách 5D pro hrubování a 3D pro dokončování. Se zvyšujícím se vyložением dochází ke snížení mechanické stability nástroje. Vyložení nástroje bude mít tendenci k vychýlení a rovněž i k harmonickému (vysokofrekvenčnímu) kmitání. Harmonické kmitání může způsobit pohyb ustavené součásti během vyvrtávání, což může vést k odchylce rozměrů nebo vzniku kuželovité otvory. V mnoha případech může být vysokofrekvenční harmonické kmitání zmírněno zvýšením posuvu a (nebo) snížením řezné rychlosti. Mějte na paměti, že se proces vyvrtávání mění s ohledem na velikost vyvrtávací hlavy (držáku destiček), což vyžaduje úpravu řezných rychlostí a posuvů.

Hloubka vrtání – vyložení nástroje u mikro vyvrtávacích hlav

Maximální hloubka vyvrtávání pomocí ocelových vyvrtávacích tyčí by neměla přesáhnout 5D a 7D v případě karbidových vyvrtávacích tyčí. Doporučujeme zkrátit tyče na co nejkratší přesah nezbytný s ohledem na požadovanou hloubku vrtání. Pro náročné aplikace hrubování by měl být vybrán co největší poloměr špičky destičky, pokud není uvedeno jinak. Pro dokončovací vyvrtávání s velmi malým úběrem materiálu je nejvýhodnější volit co nejmenší poloměr špičky destičky, aby se minimalizoval boční průhyb nástroje. To může být důležité zejména u aplikací zahrnujících dlouhé vyložení.

Montáž posuvníků na vyvrtávací hlavu

Nasuňte posuvníky do V drážky ve vyvrtávací hlavě, zasuňte až do polohy, kdy se střetne osa otvoru posuvníku s otvorem v nastavitelné matici. Upevněte šrouby (pozice 1) a lehce je utáhněte. Tyto šrouby zajišťují pohyb posuvníků ve V drážce. Na závěr zkontrolujte, zda se posuvníky posouvají bez odporu. Nastavte vyvrtávací tyč na požadovaný průměr a utáhněte dva šrouby pro aretaci posuvníků (pozice 2). Upozorňujeme, že pro využití celkového rozsahu vyvrtávací tyče, jsou na posuvnících dvě sady otvorů ve vzdálenosti 15 mm.

HRUBOVÁNÍ

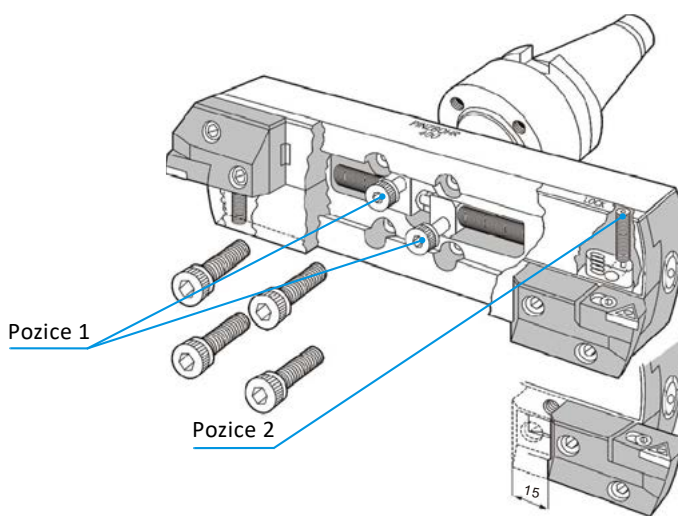

Hrubovací vyvrtávací hlavy 75° vůči 90°

75° hrubovací vyvrtávací hlavy by měly být použity pokaždé, když se odebrá mnoho materiálu a není vyžadována kolmost vnitřku slepého otvoru nebo osazení otvoru. Úhel 75° má sklon k samovyštěření na již předvrtaný otvor, a tím je následně zajištěn i velmi stabilní řez. Je-li předvrtaný otvor posunutý mimo osu nebo mimo úhel, doporučuje se použít 90° vyvrtávací hlavu, protože 90° vodící úhel bude mít menší sklon následovat předvrtaný otvor.

Množství odebíraného materiálu

Maximální množství odebíraného materiálu pro hrubovací vrtání (vyvrtávání) by mělo být sníženo u velmi tvrdých materiálů, delších vyložení a rovněž u širších posuvných ramen.

Poloměr špičky destičky

Pro náročné aplikace hrubování by měl být vybrán co největší poloměr špičky destičky, pokud není uvedeno jinak. Pro dokončovací vrtání s velmi malým úběrem materiálu je nejvýhodnější volit co nejmenší poloměr špičky destičky, aby se minimalizoval boční průhyb nástroje. To může být důležité zejména u aplikací zahrnujících dlouhé vyložení.

4 Řezné hrany na destičce

80° tvar destičky nabízí obvykle dvě řezné hrany. Nicméně, všechny čtyři řezné hrany mohou být použity u 75° a 90° hrubovacích vyvrtávacích hlav ve stejném rozmezí velikostí. To samé je možné i mezi 75° hrubovací vyvrtávací hlavou a 90° dokončovací vyvrtávací hlavou.





SIMPLY RELIABLE

Jako odborníci můžete sami pouhým pohledem na třísku posoudit kvalitu odvedené práce. Tříska svým čistým a jednoduchým tvarem v sobě nese příběh. Naše tříska je jasný a neměnný ukazatel a proto je naším symbolem. **Jsme jednoduše spolehliví.**

DORMER PRAMET

Austria

T: +31 10 2080 240
info.at@dormerpramet.com

Belgium & Luxembourg

T: +32 3 440 59 01
info.be@dormerpramet.com

Brazil

T: +55 11 5660 3000
info.br@dormerpramet.com

Canada

T: (888) 336 7637
En Français: (888) 368 8457
cs.canada@dormerpramet.com

China

T: +86 21 2416 0508
info.cn@dormerpramet.com

Croatia

T: +385 98 407 489
info.hr@dormerpramet.com

Czech Republic

T: +420 583 381 111
info.cz@dormerpramet.com

Denmark

T: 808 82106
info.se@dormerpramet.com

Finland

T: 0205 44 7003
info.fi@dormerpramet.com

France

T: +33 (0)2 47 62 57 01
info.fr@dormerpramet.com

Germany

T: +49 9131 933 08 70
info.de@dormerpramet.com

Hungary

T: +36-96 / 522-846
info.hu@dormerpramet.com

India

T: +91 11 4601 5686
info.in@dormerpramet.com

Italy

T: +39 02 30 70 54 44
info.it@dormerpramet.com

Kazakhstan

T: +7 771 305 11 45
info.kz@dormerpramet.com

Mexico

T: +52 (555) 7293981
cs.mexico@dormerpramet.com

Netherlands

T: +31 10 2080 240
info.nl@dormerpramet.com

Norway

T: 800 10 113
info.se@dormerpramet.com

Poland

T: +48 32 78-15-890
info.pl@dormerpramet.com

Portugal

T: +351 21 424 54 21
info.pt@dormerpramet.com

Romania

T: +4(0)730 015 885
info.ro@dormerpramet.com

Russia

T: +7 (495) 775 10 28
info.ru@dormerpramet.com

Slovakia

T: +421 (41) 764 54 60
info.sk@dormerpramet.com

Slovenia

T: +385 98 407 489
info.si@dormerpramet.com

Spain

T: +34 935717722
info.es@dormerpramet.com

Sweden

responsible for Iceland
T: +46 35 16 52 96
info.se@dormerpramet.com

Switzerland

T: +31 10 2080 240
info.ch@dormerpramet.com

Turkey

T: +90 533 212 45 47
info.tr@dormerpramet.com

Ukraine

T: +38 067 566 38 80
T: +38 067 566 81 51
info.ua@dormerpramet.com

United Kingdom

responsible for Ireland
T: 0870 850 4466
info.uk@dormerpramet.com

United States of America

T: (800) 877-3745
cs@dormerpramet.com

Other countries

South America

T: +55 11 5660 3000
info.br@dormerpramet.com

Adria

T: +420 583 381 527
info.rcee@dormerpramet.com

Rest of the World

Dormer Pramet International UK
T: +44 1246 571338
info.int@dormerpramet.com

Dormer Pramet International CZ
T: +420 583 381 520
info.int.cz@dormerpramet.com

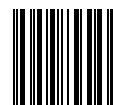

881098

DP-CAT-HOLEMAKING-2021-CZ

FOLLOW US...



www.dormerpramet.com



youtube.com/dormerpramet



facebook.com/dormerprametsocial



linkedin.com/company/dormerpramet



instagram.com/dormerprametsocial



twitter.com/dormerpramet